

Statistical entropy analysis as tool for circular economy: Proof of concept by optimizing a lithium-ion battery waste sieving system

Reuter, M. A.; van den Boogaart, K. G.; Lundströma, M.; Santasalo-Aarnioa, A.; Velázquez Martíneza, O.; Serna-Guerreroa, R.;

Originally published:

December 2018

Journal of Cleaner Production 212(2019), 1568-1579

DOI: <https://doi.org/10.1016/j.jclepro.2018.12.137>

Perma-Link to Publication Repository of HZDR:

<https://www.hzdr.de/publications/Publ-28691>

Release of the secondary publication
on the basis of the German Copyright Law § 38 Section 4.

CC BY-NC-ND

Statistical Entropy Analysis as Tool for Circular Economy: Proof of Concept by Optimizing a Lithium-Ion Battery Waste Sieving System

O. Velázquez Martínez ⁽¹⁾, K. G. Van Den Boogaart ⁽²⁾, M. Lundström ⁽¹⁾, A. Santasalo-Aarnio ⁽¹⁾, M. Reuter ⁽²⁾, R. Serna-Guerrero ^{(1)*}

(1) Department of Chemical and Metallurgical Engineering, School of Chemical Engineering, Aalto University, P.O. Box 16200, 00076 Aalto, Finland

(2) Helmholtz Institute Freiberg for Resource Technology, Chemnitz Str. 40, 09599 Freiberg, Germany

*Correspondence to rodrigo.serna@aalto.fi

Abstract

With the concept of circular economy gaining strength as an alternative for the sustainable production of raw materials, there is an inherent need to develop methods capable of quantifying the efficiency of recycling systems, provide guidelines for optimization of existing technologies, and support the design of new products based on sound, scientific and engineering principles. The work hereby presented proposes the use of statistical entropy coupled with material flow analysis as a basis for the optimization of separation and purification processes. Unlike other efficiency parameters, this approach provides an analysis of component concentration or dilution from a systemic perspective, taking into consideration products, by-products and waste streams. As a proof-of-concept, a sieving process for waste lithium-ion batteries (LIB¹) was chosen. It is demonstrated that using this approach it is possible to determine the stages that do not contribute to the concentration of components thus offering guidelines for process optimization. In the present case, the total number of sieving stages can be decreased with a minimum impact on the concentration of the products. In comparison, it is also shown that the widely accepted exergy analysis is not able to identify the opportunities for optimization due to the particular characteristics of this exemplary system, i.e., negligible change in energy consumption as a function of sieving stages and absence of chemical changes. Finally, the experimental results suggest that Al and Cu can be

¹ Lithium ion battery

1 concentrated using a simple sieving pre-processing step, perhaps in preparation for a
2 subsequent refining stage.
3

4
5 Keywords: Circular economy; material flow analysis; relative statistical entropy; lithium-ion
6 batteries; process simulation; process optimization
7
8
9

10 11 1. Introduction 12

13
14 The impact of human activities on the planet has become so significant that some authors
15 propose we are currently living in a new geological period dubbed the “Anthropocene”
16 (Waters et al., 2016). Among the main characteristics defining this new age are the impacts
17 related to climate change and the modification of the Earth’s crust geology with the
18 generation of anthropogenic deposits, which are directly related with an increasing demand
19 for raw materials and the associated generation of waste. The concept of circular economy
20 (CE²), for example, was developed precisely to alleviate the impact of human activity on the
21 environment as a result of an ever-increasing demand of raw materials. Although the circular
22 economy philosophy was proposed as far back as the 1970’s, it has recently gained plenty of
23 attention from the various stakeholders in the material value chain, i.e. industry, government
24 and general public (Ellen MacArthur Foundation, 2013). Recycling systems represent one of
25 the stages of the circular economy model, whose noble task is to reinsert into the economic
26 process the raw materials after the end-of-life of products, thus reducing the need to extract
27 virgin raw materials. However, recycling companies, like any other commercial enterprises,
28 are driven by economic incentives and so, current recycling activities focus only on the
29 recovery of materials with high value in the market. While this business approach is
30 understandable, it does not fulfill the ultimate goal of a circular economy, since materials in
31 which resources have been invested may end up in low-value or waste streams. CE does not
32 only mean optimizing recycling systems, but also minimizing resource loss, and by
33 consequence the future inputs. Indeed, it is well accepted that, in order to optimize a process,
34 inputs and losses should be quantified and controlled (Gutowski, 2008). By keeping valuable
35 materials within the economic cycle, i.e. reducing the losses and extending their useful
36 lifetime, the necessity to obtain virgin raw materials from natural deposits will diminish,
37
38
39
40
41
42
43
44
45
46
47
48
49
50
51
52
53
54
55
56
57
58
59

60 ² Circular Economy
61
62
63
64
65

directly translating into the conservation of natural resources. Consequently, a systemic analysis of the economic cycles from the material perspective becomes necessary.

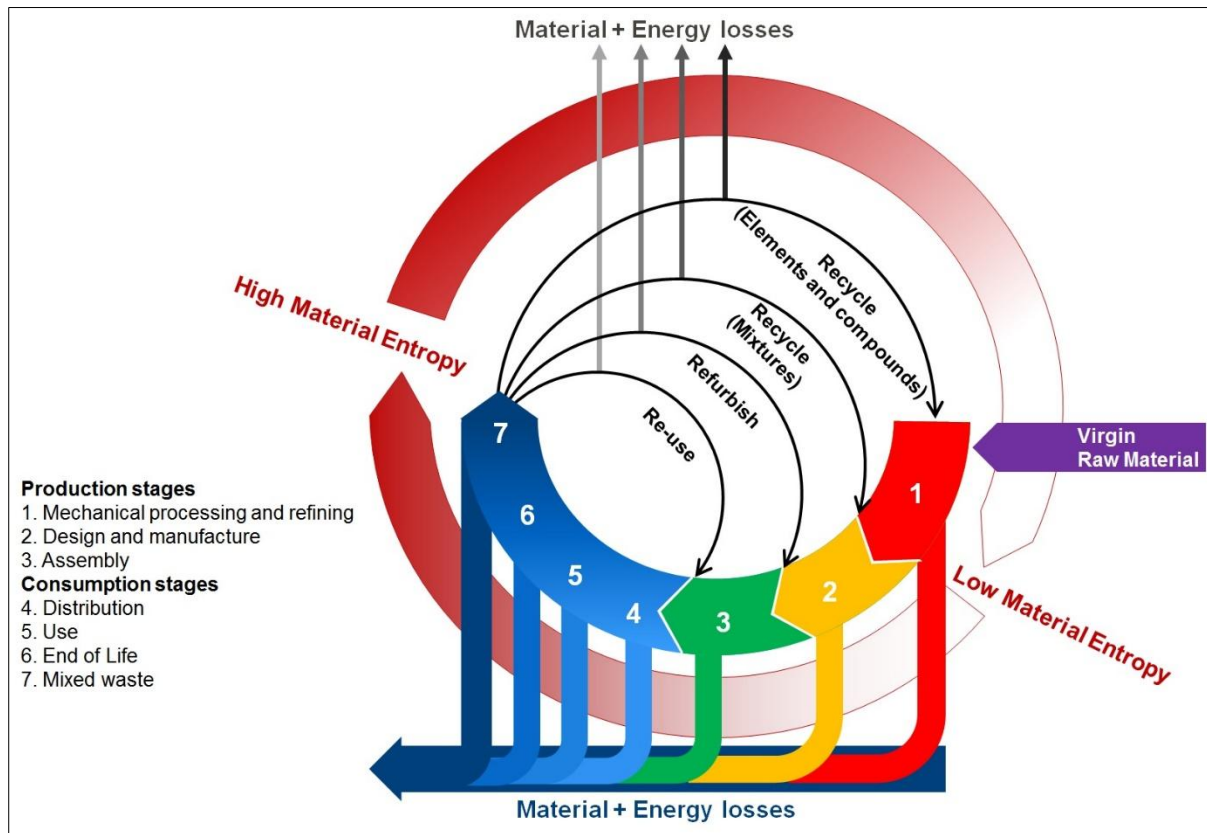


Figure 1 Circular economy model from a material-centric perspective.

While various representations of the circular economy model are available in literature, Figure 1 presents the material life cycle including a material-entropy evolution following the definition offered by the entropy of mixtures. Accordingly, the product life cycle operates by turning virgin raw materials of higher entropy into low entropy ones by processing and refining, and back into materials with high entropy levels, as it undergoes transformations into components, products, and eventually, waste. As represented by the lower part of Figure 1, every transformation step in the value chain is inherently associated with material and energy losses, depending on the efficiency of each process. This representation of CE also accounts for the possibility of different recovery actions, such as re-use, refurbish and recycle. It should be noted that material and energy losses are also inevitable in such regenerative processes. The current linear economic system is represented by the lower half of the loop (steps 1 to 7). The upper half of the loop is in charge of turning the economic system from linear to circular. Some researchers have described recovery processes as the inner loops of a circular economy, e.g., the consumer motivation to extend the lifecycle of

ubiquitous products (Wieser and Tröger, 2016). However, the latter have been mostly analyzed from the social perspectives, instead of the definition and/or optimization of recovery systems. The CE model presented in Figure 1 describes those inner loops as a function of the *usability* of the final recoveries and the resource intensity of the processing technology. In the present work, the term *usability* is defined as how adaptable the recovered raw materials are for use in products different of those from where they were harvested. This approach is particularly necessary for the analysis of products containing materials with high degree of complexity, such as lithium-ion batteries (LIBs). Indeed, complex materials have the possibility to be reinserted into the economic cycle either as: i) components, ii) substances, or iii) pure chemical compounds or elements. For the sake of clarity, in the context of the work hereby presented the following definitions are used.

- i. Component: a functional constituent of a product
- ii. Substance: a heterogeneous mixture of compounds or elements
- iii. Compound: elements chemically bonded
- iv. Element: pure chemical elements

The level at which these materials are reinserted results in a higher or lower degree of usability, but with the caveat of a proportionally higher degree of processing intensity (resource consumption) and waste generation. Figure 1 introduces a new dimension for the design of recycling systems, e.g., whether a process can use substances as raw material or whether additional resources should be invested to achieve a recovery of elements. A decision like this should be based on the losses and costs of the recycling systems. A clear and sound definition of the loops is not an easy task, as it should take into consideration the complexity of the end-of-life products, the potential recycling steps (e.g., mechanical, hydrometallurgical, pyrometallurgical), and the potential quality of the possible recyclates. As will be described next, among the various alternatives to provide quantitative guidelines to define recycling systems. Material Flow Analysis (MFA³) coupled with information theory concepts, i.e. relative statistical entropy (RSE⁴), is an interesting tool to design and optimize recycling processes.

MFA is a systematic assessment of the flow of a substance throughout a system within a defined system boundary, delivering a complete scope of the stock and flow of materials making evident the minor changes in it (Brunner and Rechberger, 2011). Reportedly, the

³ Material Flow Analysis.

⁴ Relative Statistical Entropy.

1 application of MFA and statistical entropy to different material flow systems has produced
2 positive outcomes in the resource management field. This has been used, for example, to
3 improve the efficiency of a smelting operation by locating losses (Bai et al., 2015), setting the
4 base for an improved resource management by analyzing the Cu flow in Europe and P and N
5 in Austria (Laner et al., 2017; Rechberger and Graedel, 2002; Sobantka et al., 2014), and as a
6 tool to support waste management decisions (Rechberger and Brunner, 2002). Nevertheless,
7 the use of this methodology has been focused on the description of the studied system and not
8 applied as an optimization guideline for recycling systems. Optimization as a driver of
9 economic development, is studied from multiple fronts. As example, (Abadías Llamas et al.,
10 2019; Amini et al., 2007; Ignatenko et al., 2007) center their efforts into quantifying exergy
11 losses in operations of copper production and recycling as an optimization driver towards CE.
12 In parallel, (Bharani and Praveen Prakash, 2015; Gharaei and Pasandideh, 2016) describe an
13 optimization approach from a supply-chain perspective, i.e. supplier, producer, wholesaler
14 and retailer; (Gharaei et al., 2018, 2017; Gharaei and Pasandideh, 2017) by developing a
15 model to obtain an ideal lot-size for supply chain. On the other hand, (Duan et al., 2018)
16 optimizes machine maintenance scheduling based on stochastic constraints, while
17 (Sobhanallahi et al., 2016) reflects on the effect of managerial level decisions into
18 organizational success. The wide variety of focus areas within the value chain in the
19 aforementioned works reflect the interest on the study of optimization for the benefit of the
20 circular economy. Indeed, parametrization of any process is a vital step to minimize losses
21 (Gutowski, 2008). This work introduces a process optimization methodology by MFA and
22 RSE employed to analyze pre-processing stages of LIB recycling, i.e. sieving system, as a
23 proof-of-concept. Even though previous applications of MFA and RSE for resource
24 management have brought positive outcomes (Bai et al., 2015; Laner et al., 2017; Rechberger
25 and Brunner, 2002; Rechberger and Graedel, 2002; Sobantka et al., 2014) the present work
26 reaches the point of process optimization upon which organizational decisions can be based.

27
28
29
30
31
32
33
34
35
36
37
38
39
40
41
42
43
44
45
46
47
48 Admittedly, the use of exergy analysis to unveil the resource usage efficiency during
49 recycling systems has been widely accepted (Amini et al., 2007; Ignatenko et al., 2007).
50 However, these applications are mostly focused on thermal and chemical processes, setting
51 aside physical separation processes. The treatment of LIB waste by sieving was chosen as
52 *proof-of-concept* to demonstrate the positive impact of other types of analyses, namely
53 *statistical entropy analysis*, on separation processes for process optimization. The present
54 system was carefully selected to demonstrate the use of RSE vis-à-vis exergy, since: i) it
55
56
57
58
59
60
61
62
63
64
65

depicts a concentration action of some the constituents while not presenting chemical changes under standard conditions of temperature and pressure, and ii) it entails a marginal impact on resource consumption upon addition or subtraction of sieving stages. Thus, as will be detailed, this is a system where the optimization of separation stages cannot be associated with changes in exergy.

1.1 The relevance of LIB recycling

The forecasted increase in production of LIBs in the upcoming years will potentially result in an large stream of end-of-life batteries, making them an important source of valuable materials (Pillot, 2016). The demand for LIB is associated with an increased market for electric vehicles, driven by government efforts and public awareness to decelerate global warming by limiting CO₂ emissions (European Commission, 2014). Associated to it, an upsurge on the demand for raw materials for LIBs is expected. For example, the demand for cathode active materials was ca. 140,000 tons in 2015 and is forecasted to reach ca. 390,000 tons by 2025 (Pillot, 2016; Scott, 2017). Unfortunately, an estimate of 95% of the LIBs produced in Europe that reach an end-of-life point are not recycled, most of them ending as a fraction of landfilling material (Friends of the Earth, 2013; Heelan et al., 2016). This open loop in the economic system requires that all constituents of LIBs (Table 1) be mostly processed and manufactured from virgin raw materials.

Table 1 Components of a common LIB. PVDF stand for Polyvinylidene Fluoride.

Elemental form of LIB component	LIB Constituent	w/w%	Component form of LIB
Al	Current Collectors	~13%	Al foil
Cu			Cu foil
Mn	Cathode	~27%	Li(MnNiCo)O ₂ , LiFePO ₄
Co			
Ni			
Li	Cathode / Electrolyte	~27% / ~10%	Li(MnNiCo)O ₂ , LiFePO ₄ / LiPF ₆
C	Anode	~17%	Graphite
Fe	Casing	~25%	Steel
Others	Binder / Separator	~4% / ~4%	PVDF / Polymer

1
2
3
4
5
6
7
8
9
10
11
12
13
14
15
16
As seen in Table 1, LIBs are not simple devices from the material perspective, as they contain a wide variety of components, especially in the electrodes and electrolyte (Georgi-Maschler et al., 2012; Heelan et al., 2016; Julien et al., 2014; Linden and Reddy, 2011; Nitta et al., 2015). By some accounts, the number of elements present in a LIB may further increase in the future, as new formulations are explored to offer higher energy capacity and a larger product life span (Goonetilleke et al., 2018; Hailey and Kepler, 2015; Heelan et al., 2016; Wang et al., 2014). Nevertheless, the fast-paced research and development in the LIB field is driven by a design-for-performance approach that rarely considers its impact on the consumption of natural resources.

17
18
19
20
21
22
23
24
25
26
27
28
29
30
31
32
33
34
35
36
37
38
39
40
41
42
43
44
45
46
47
48
49
50
51
52
53
54
State-of-the-art recycling systems, such as the Val'Eas process by Umicore, are mostly focused on the recovery of a few metallic components of LIBs (Diekmann et al., 2017; U.S. Department of the Interior and U.S. Geological Survey, 2017). Co is of interest due to its high market value, while Al, Cu and Fe are targeted due to their relative simple recovery and refining through pyrometallurgical processes. However, the remaining compounds and elements (e.g., Ni, Li, Mn, C, PVDF) are either lost or downgraded since their current market value makes their recovery uneconomical using State-of-the-Art recycling technologies (Pistoia, 2014; Porvali et al., 2019). Recent works suggest that the addition of mechanical processing operations, e.g. crushing, sieving, can be used to improve the recovery of materials from LIB waste (Al-Thyabat et al., 2013). Emerging LIB recycling technologies (e.g., Accurec, Gratz, LithoRec, and OnTo) reportedly recover a larger variety of compounds compared to industrial processes by including more intensive mechanical pre-processing operations. Emerging recycling processes for LIBs also consider the use of low temperature hydrometallurgical processes to prevent losses associated with high-temperature pyrometallurgical refining (Porvali et al., 2019). These processes with higher recovery efficiency bring us closer the CE concept, however their benefits may be dimmed as additional operations are bounded to systemically increase the generation of waste (Al-Thyabat et al., 2013; Swain, 2017; Zhang et al., 2013). Thus, it is of great importance to benchmark the performance of recycling systems based on a systemic analysis of their resource consumption, quality of recovery and material loss into waste streams.

55 56 57 58 59 60 61 62 63 64 65 2. Materials and Methods

The present chapter describes the methodology to apply RSE analysis on experimental data, using mechanical processing, i.e. the separation of shredded LIB waste as case study. Hereby,

1 the mathematical background for the calculation of RSE is introduced, followed by the
2 application of MFA and RSE to the sieving system under study. Finally, the background for
3 exergy analysis applied to the sieving system is presented, as it will be used for comparison
4 with the methodology hereby proposed.
5
6

7 2.1 Physical and Chemical Characterization of LIB Waste

8 The samples of crushed LIB waste fractions were obtained directly from the facilities of a
9 Finnish battery recycling company. As the sample comes from industrial operations, it is
10 expected to contain multiple types of LIBs, rather than a single battery chemistry. The
11 company performed a preliminary sieving directly after crushing as part of their regular
12 operations and thus, it was not possible to obtain a crushed sample without this preliminary
13 separation. The total weight of the mixed sample used in the sieving experiment was 189 g.
14 Even though the fractions were received without further information, some differences in
15 their physical appearance were evident.
16
17
18
19
20
21
22
23

- 24 i. Fraction A (Figure 2, A) appears to be formed mostly by metallic foils, likely
25 conformed by Al, Cu, and Fe.
- 26 ii. Fraction B (Figure 2, B) is mainly in the form of fine black powder with the presence
27 of small metallic particles. Thus, it is likely that the fine fraction has a significant
28 presence of cathode, anode, binder and separator materials.
29
30
31
32
33
34
35
36
37



38
39
40
41
42
43
44
45
46
47
48
49 *Figure 2 Pictures of representative samples of the LIB waste used in this study (A) overflow*
50 *and (B) underflow fractions*

51
52 With the aim of producing a feed stream representative of the entire range of particles
53 obtained after crushing, a 1:1 mixture of coarse (overflow) and fine (underflow) fractions was
54 used as feed in the sieving experiments. A Retsch AS 300 vibrating sieve processed the waste
55 LIB sample for 20 minutes using different nominal mesh opening sizes in decreasing order.
56
57
58
59
60
61
62
63
64
65

the results of this sieving experiment were used on the development of a new process for the recycling of LIB recently published by our research group (Porvali et al., 2019).

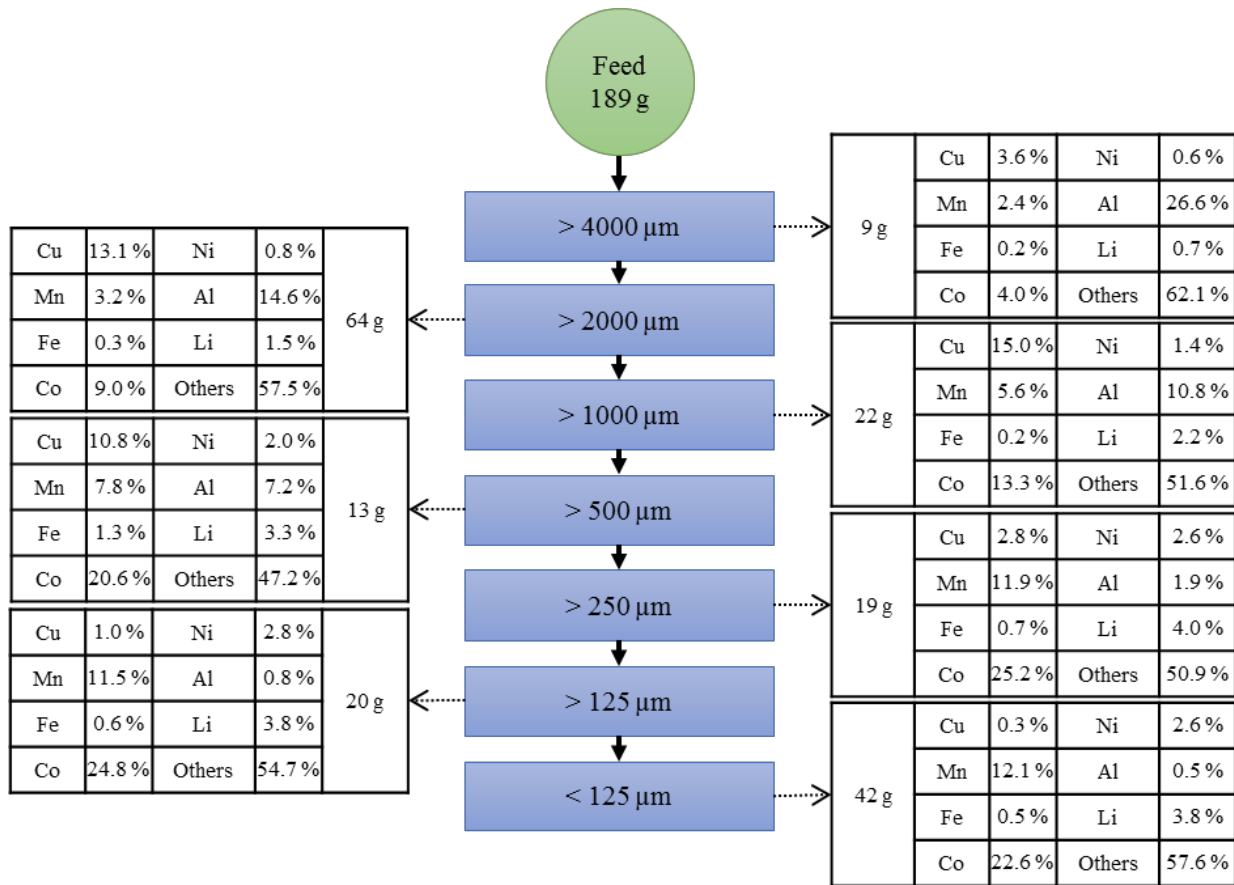


Figure 3 Flow diagram of the sieving system, including elemental composition at each size fraction

The chemical characterization of the sieved fractions was carried out by a private, certificated laboratory using Inductively Coupled Plasma Mass Spectrometry (ICP) for of Al, and by Atomic Absorption Spectroscopy (AAS) for Li, Fe, Ni, Co, Mn, and Cu. The mass of unknown composition in each fraction was collectively labeled as *Others*.

2.2 Mathematical background of RSE analysis

The term entropy, initially described by Clausius, has been developed to address phenomena in different scientific fields, e.g., statistical thermodynamics with Gibbs and Boltzmann theories (Cengel and Boles, 2015) and information theory as developed by Claude E. Shannon (Shannon, 1948). Although the work in both fields try to explain a similar phenomenon sometimes referred as *chaos in a system*, and present similar mathematical forms, the relationship between them is still under debate (Balibrea, 2016). While statistical or Shannon's entropy H describe the loss or gain of information in a system, the definition of thermodynamic entropy S given by Gibbs and Boltzmann refers to the amount of random

states in a system (Brunner and Rechberger, 2011; Cengel and Boles, 2015). Reflecting their application areas, H is measured in bits of information [bit] and S in [J/mol*K].

As has been described by other authors (Gutowski, 2011), statistical entropy is analogous to the entropy of mixtures and can be used to describe the concentration of an element or compound as it undergoes transformations in a system. Material Flow Analysis (MFA) coupled with H (or its relative counterpart, RSE) offers the advantage that, using a single parameter, it is possible to evaluate the concentrating action of a system from a systemic perspective. Indeed, by applying MFA, the value of H at any given stage takes into consideration all the streams produced in the preceding stages, and as a consequence, it will influence the H value in the following stages. This section presents the mathematical background used in this work to describe the evolution of RSE of the sieving system (Brunner and Rechberger, 2011).

As this methodology analyzes the mass flow in a system, it is necessary to properly define its boundaries. A system is described by the total number of processes n and stages q (where $q = n + 1$) it entails. Simultaneously, the stages are described by all streams generated by all preceding processes. The statistical entropy of each i^{th} component in a stream, part of a total amount of components k , is function of its concentration and its corresponding standardized mass fraction. Equation 1 gives the statistical entropy, $h_{i,s}$, of an i^{th} element in the s^{th} stream.

$$h_{i,s} = -\tilde{m}_{i,s} c_{i,s} \log_2(c_{i,s}) \geq 0 \quad (1)$$

Where, $c_{i,s}$ is the concentration of the i^{th} component in the s^{th} stream, and, $\tilde{m}_{i,s}$ is the standardized mass fraction of the i^{th} component in the s^{th} stream, the latter calculated with Equations 2 and 3:

$$\tilde{m}_{i,s} = \frac{\dot{m}_s}{\sum_s \dot{X}_i} \quad (2)$$

$$\dot{X}_i = \dot{m}_s c_{i,s} \quad (3)$$

Where \dot{m}_s is the mass-flow of the s^{th} stream and \dot{X}_i is the total substance flow induced by i^{th} component. It is thus possible to account for the entropy distribution of a component in each stage by the total statistical entropy of $H_{i,q}$, Equation 4.

$$H_{i,q} = \sum_q h_{i,s} \quad (4)$$

Where $H_{i,q}$ is the statistical entropy of the i^{th} component, in the q^{th} stage. $H_{i,q}$ conveys the trend of the i^{th} component to either concentrate or dilute as it undergoes the process

1 stages. The value of relative statistical entropy (RSE), Equation 5, makes possible the
 2 comparison between different elements present in the same system. RSE, Equation 6,
 3 requires an arbitrary benchmark, which is typically the maximum level of entropy of the i^{th}
 4 component in the system, $H_{i,q}^{max}$. In the specific system under study, the maximum level of
 5 entropy corresponds to the entropy of the feed stream. Equations 5 and 6 present the $H_{i,q}^{max}$
 6 benchmark and the RSE values, respectively.
 7
 8
 9

$$10 \quad H_{i,q}^{max} = \log_2 \left[\sum_q \tilde{m}_{i,q} \right] \quad (5)$$

$$11 \quad RSE_{i,q} = \frac{H_{i,q}}{H_{i,q}^{max}} \quad (6)$$

12 Where, $H_{i,q}^{max}$ is the maximum entropy of the i^{th} component in the q^{th} stage. It is proposed to
 13 apply such benchmark to obtain the RSE value as $H_{i,q}^{max}$ equals the entropy level fed into the
 14 system. $RSE_{i,q}$ is the relative statistical entropy of the i^{th} component in the q^{th} stage. Any RSE
 15 value is limited between 0 and 1, simplifying the analysis between components and stages.
 16 An RSE value approaching 0 means that the component is being concentrated, while an RSE
 17 value tending to 1 means the opposite. Furthermore, due to the additive nature of the RSE,
 18 Equation 6 can be transformed to Equation 7 to describe the entropy of every component in
 19 the system, thus, presenting the systemic perspective of the RSE analysis:
 20
 21
 22
 23
 24
 25
 26
 27
 28
 29
 30
 31
 32
 33

$$34 \quad RSE_q^{total} = \frac{\sum_{i=1}^k H_{i,q}}{\sum_{i=1}^k H_{i,q}^{max}} \quad (7)$$

35 Where, RSE_q^{total} is the total Relative Statistical Entropy at the q^{th} stage, $\sum_{i=1}^k H_{i,q}$ reflects the
 36 total statistical entropy of the group of k components in the q^{th} stage, and $\sum_{i=1}^k H_{i,q}^{max}$ the total
 37 maximum statistical entropy of the k total of components in the same stage.
 38
 39
 40
 41
 42
 43
 44

45 2.3 Mathematical Background of Exergy Analysis of a Sieving System

46 In its classical definition, exergy indicates the capacity of matter and energy to produce
 47 useful work in a system (Kotas, 1995). Exergy is framed by both the first and second laws of
 48 thermodynamics. While the first law establishes the conservation of energy, exergy can be
 49 lost with the increase of entropy defined in the second law of thermodynamics (Cengel and
 50 Boles, 2015). The freedom that exergy possesses from the conservative laws of
 51 thermodynamics has become a cornerstone for process optimization by exergy analysis.
 52 Optimization of processes via exergy analysis entails the quantification of exergy changes
 53 due to material and energy flows in and out of a defined system. In simple terms, the internal
 54
 55
 56
 57
 58
 59
 60
 61
 62
 63
 64
 65

exergy losses are a result of entropy gain within the system, while external exergy losses are associated with the loss of matter, heat and radiation. The chemical exergy of a stream is calculated as the sum of chemical exergies of the components and the entropy change of mixing (Ignatenko et al., 2007):

$$E = \sum n_i e_i + RT_0 n \sum x_i \ln(x_i) \quad (8)$$

Where E is the total chemical exergy of the analysed stream; n_i , the total amount of moles of the component i ; e_i , the specific chemical exergy of i ; x_i , the molar fraction of i ; R , the universal gas constant (8.3144 J mol⁻¹ K⁻¹); T_0 , the environment temperature [K]; and, n , the total number of moles in the stream. Similarities can be observed between Equations 1 and the second term of Equation 8. Indeed, Equation 1, and by extension Equation 4 are mathematically analogous forms of the thermodynamic entropy of mixtures. While it may be possible to evaluate the entropy change of the sieving system by applying Equation 8, as explained by (Gutowski, 2011) RSE presents the advantage that it can represent non-molar mixtures and can be eventually used to determine the costs of separation stages.

For the sieving system discussed hereby, the first term of Equation 8, i.e. the chemical exergy term, remains constant in the system due to the fact that the mass in the system is conserved and its constituent chemical species remain unchanged. Nonetheless, the exergetic efficiency ψ can be obtained for the sieving system, presented in Equation 9 in general form and Equation 10 in extended fashion (Gutowski and Sekulic, 2011):

$$\psi = \frac{\sum E_{products}}{\sum E_{input}} \quad (9)$$

$$\psi = \frac{\sum E_{input} - (\sum E^{waste} + E^Q + \Delta E^{Destruct})}{\sum E_{input}} \quad (10)$$

Where $\sum E_{products}$ is the exergy of the products; $\sum E_{input}$ is the total exergy input to the system, including those coming from material and energy (e.g., electricity, heat); $\sum E^{waste}$, is the material exergy of the waste stream; E^Q , the exergy due to heat transfer; and, $\Delta E^{Destruct}$, is the exergy destruction within the system due to irreversibilities. In the analysed sieving system, considered to be a closed system where only physical separation happens E^Q and $\Delta E^{Destruct}$ are considered to be negligible particularly since it is assumed that the sieves operate at constant temperature. The term $\sum E_{input}$ accounts for the feed of material in their chemical exergy form (Equation 8), and exergy input from energy sources. Thus, Equation 10 yields:

$$\psi = 1 - \frac{\sum E^{waste}}{\sum E_{Energy} + \sum E_{Feed}} \quad (11)$$

As seen in Equation 11 the value of ψ depends heavily on the $\sum E^{waste}$ term as the rest can be considered constant for this sieving system. In the present system, the passing material is considered to be the *useful product*. Thus, as the throughput undergoes sieving, there is a systemic increase on the amount of side and/or waste streams within the boundaries of the system, decreasing systematically the exergetic efficiency. In addition, exergy efficiency relies on the definition of a stream as a *useful product*. This lack of systemic perspective may result in losses of valuable information, possibly leading to errors of interpretation if, for example, two or more streams can be considered products in reality or if the stream with the most suitable product is unknown a priori. Furthermore, while ψ accounts for the efficiency of the resources used, which is continuously decreasing in the system hereby presented, it does not reflect the contribution of the system towards concentration of components. In such scenarios, applying RSE becomes a useful, complementary tool for the analysis and decision-making regarding physical separation processes, or processes with similar characteristics as the one hereby studied.

In the following section exergy efficiency is evaluated in comparison to RSE. The specific chemical exergy, e_i , values applied are presented in Table 2, and to account for energy usage, a value of 410 W was assumed, according to the specification of the equipment with a 75% efficiency, based on the typical range expected for electrical motors. The operation time of 20 min leads to an energy input of 360 kJ to perform the separation of the waste LIB. Hence, $\sum E_{Energy} = 360 \text{ kJ}$, as it is the only input of energy to the system.

Table 2 Specific chemical exergies of the elements in standard environmental conditions $T=298.15\text{K}$ and $P=101.325 \text{ kPa}$ (Bakshi et al., 2011; Szargut, 1989).

Li	Fe	Ni	Co	Mn	Cu	Al	C
[kJ/mol]	[kJ/mol]	[kJ/mol]	[kJ/mol]	[kJ/mol]	[kJ/mol]	[kJ/mol]	[kJ/mol]
393.0	374.3	232.7	265.0	487.7	134.2	795.7	409.87

Although admittedly several of the LIB components are found as chemical compounds, the use of elemental specific chemical exergies was necessary for this proof-of-concept since, due to the heterogenous nature of waste LIB it is not possible to determine the exact chemical formulations used by all manufacturers. Moreover, this may be a reasonable approximation considering that no chemical changes occur within the system and thus the exergy changes are based on the distribution of elements which are directly associated with the compounds

they belong to. Finally, it is relevant from the raw materials production perspective to trace valuable elements, even if they are in the form of chemical compounds.

2.4 Application of MFA, RSE and Exergy Analysis to the Sieving System

Following MFA methodology, the sieving system is formed by a set of 6 sieving processes (i.e., $n = 6$), hence 7 stages, as depicted in Figure 4 in the form of a *node-stage diagram*. In Figure 4, even-numbered S-nodes and S13 were analyzed for a total of 7 elements (Al, Cu, Mn, Co, Ni, Li, Fe), leaving the materials of unknown composition as *Others*. Odd-numbered nodes, excluding S13, were obtained by mass-balance.

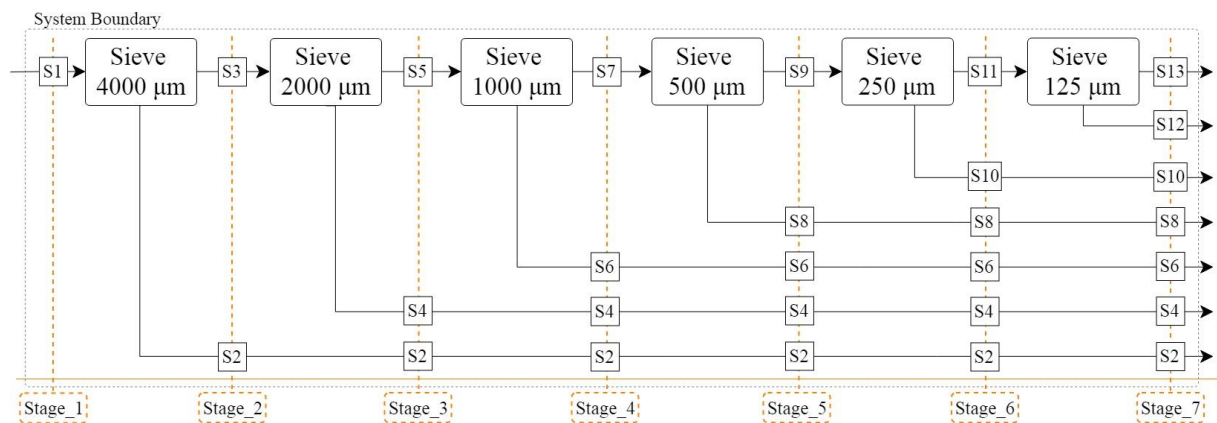


Figure 4 Node-stage diagram of the sieving system

The RSE value at any given stage is defined by the streams produced during the same and previous processes. As an example, *Stage_2* is described by streams *S2* and *S3*. Moving downstream, the number of streams present at each stage increases until *Stage_7*, which is described by *S2*, *S4*, *S6*, *S8*, *S10*, *S12*, and *S13*. The exergy analysis requires the definition by the user of material input and products. In this case, the input material is the same as in the RSE Analysis, *S1*, while the definition of *product* will be that of *underflow* fractions streams: *S3*, *S5*, *S7*, *S9*, *S11*, and *S13*. Therefore, the E^{waste} term for Equation 11 is a gradual addition of the streams: *S2*, *S4*, *S6*, *S8*, *S10*, and *S12*, as the analysis evaluates from first to last stages.

At this point, there is a notorious difference on application perspective between RSE and exergy analysis, as ψ requires the definition of a product stream whose exergy is indirectly calculated through the chemical exergy of the waste. RSE, on the other hand considers the totality of nodes along the system. In a similar way, both RSE and exergy, value will depend on a larger amount of variables as a system increases its length. As a result, a single processing step in a complex system will have a lower impact on both analyzes. Therein lies one of the advantages of using RSE coupled with MFA: a system with a single, highly

efficient process will be penalized if it is preceded or succeeded by a series of inefficient separations.

3 Results and Discussion

3.1 Chemical and Physical Characterization of LIB Waste

Figure 5 presents the cumulative results of the chemical composition with respect to the various size fractions obtained. It is common practice to use this type of distribution curves to determine a cutting point for enrichment operations, basing this decision on the value at which the highest relative difference between components is found.

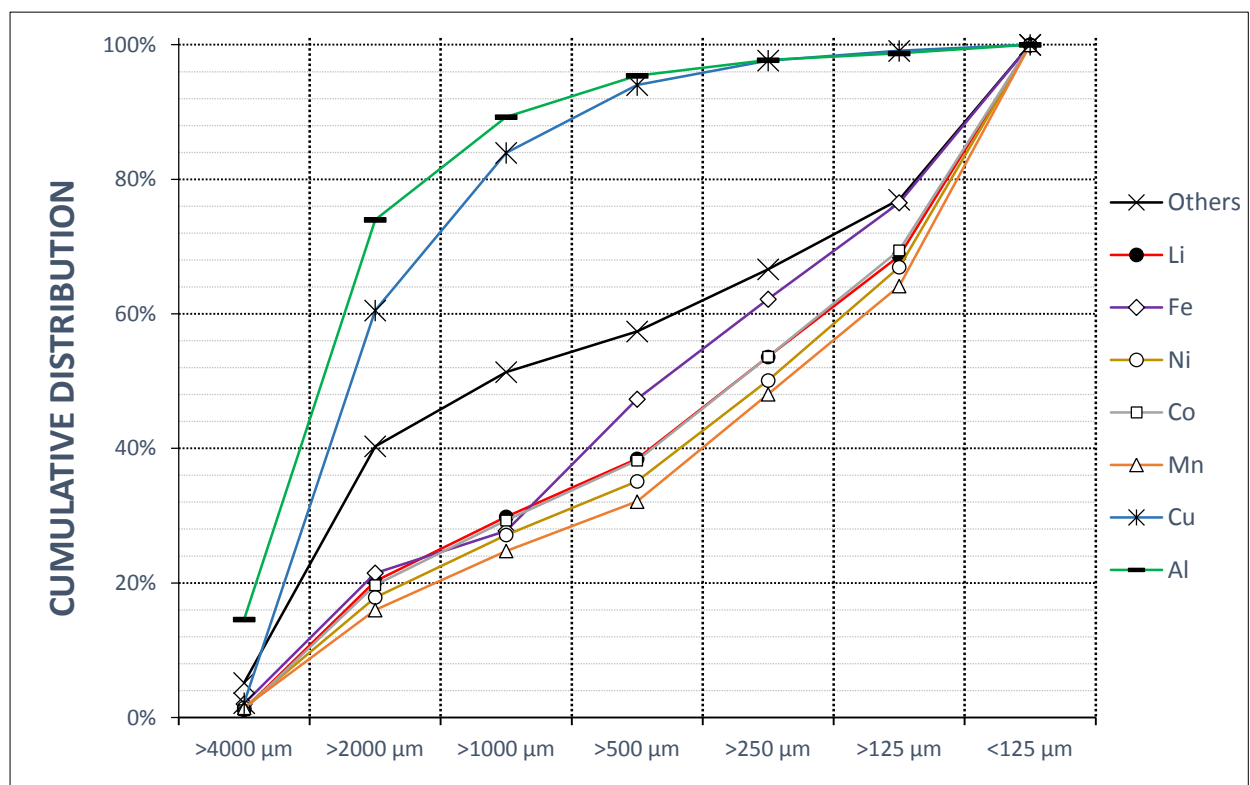


Figure 5 Separability curve of the analyzed LIB components

Figure 5, reflects that, even if the sieving system is not a concentration but a classification process, sieving LIB waste can be employed to concentrate some of its components. In addition, the current collectors of the waste LIB contain Al and Cu which, due to their mechanical properties (Beer et al., 2012), report to the larger size fractions. Over 60% of Li, Ni, Co, and Mn report to the finer fractions, meaning that these elements are present in brittle or powdered substances, such as cathode materials. It is worth pointing out that in this sample, Fe also reports at the fine fractions, suggesting that its presence is mainly found in the cathode material, rather than in the casing. Thus, it is likely the cathode material in the

1 processed material is a mixture of $\text{Li}(\text{MnNiCo})\text{O}_2$, and LiFePO_4 . In addition, Li, Ni, Co and
2 Mn are similarly distributed in all the fractions supporting the idea that they are all part of the
3 same compounds. The last stream, namely *Others*, is expected to be a mixture of graphite and
4 polymer which, as seen from Table 1, are present as anode and binder/separator, respectively.
5

6
7 Following the typical use of separability curves, it is possible to suggest from Figure 5 a
8 separation set point at the 1000 μm -opening sieve, which would result in an oversize
9 containing $> 80\%$ of metals and $< 30\%$ cathode materials. The *Others* stream is equally
10 distributed in all the fractions obtained, hence, at any separation point there will be a
11 considerate amount of graphite, and polymers. This separation set point may be used for
12 metallic recovery of the Al and Cu with a marginal losses and impurities. While this simple
13 analysis can be useful as a starting point, this approach does not take into account the
14 material losses into waste or side streams. It, therefore, lacks the possibility to provide clear,
15 quantitative guidelines for process optimization.
16
17
18
19
20
21
22
23

24 25 3.2 Statistical Entropy Analysis of a Sieving System 26

27 Figure 6 presents RSE and Exergy analyses for the experimental sieving system. The top
28 figure includes the RSE and Exergy evolution at a system level. This level of analysis is
29 proposed to be used as a first approach to unveil the concentration nature of a process and as
30 a baseline for optimization. The bottom section of Figure 6 presents the graphical
31 representation of RSE evolution at the element level. Both figures show a clear trend of
32 concentration by the system, described by the decreasing RSE value of the charts as the
33 stages go on. Optimization based on RSE is based on promoting abrupt negative slopes,
34 which are associated with strong concentrating actions.
35
36
37
38
39
40
41
42
43
44
45
46
47
48
49
50
51
52
53
54
55
56
57
58
59
60
61
62
63
64
65

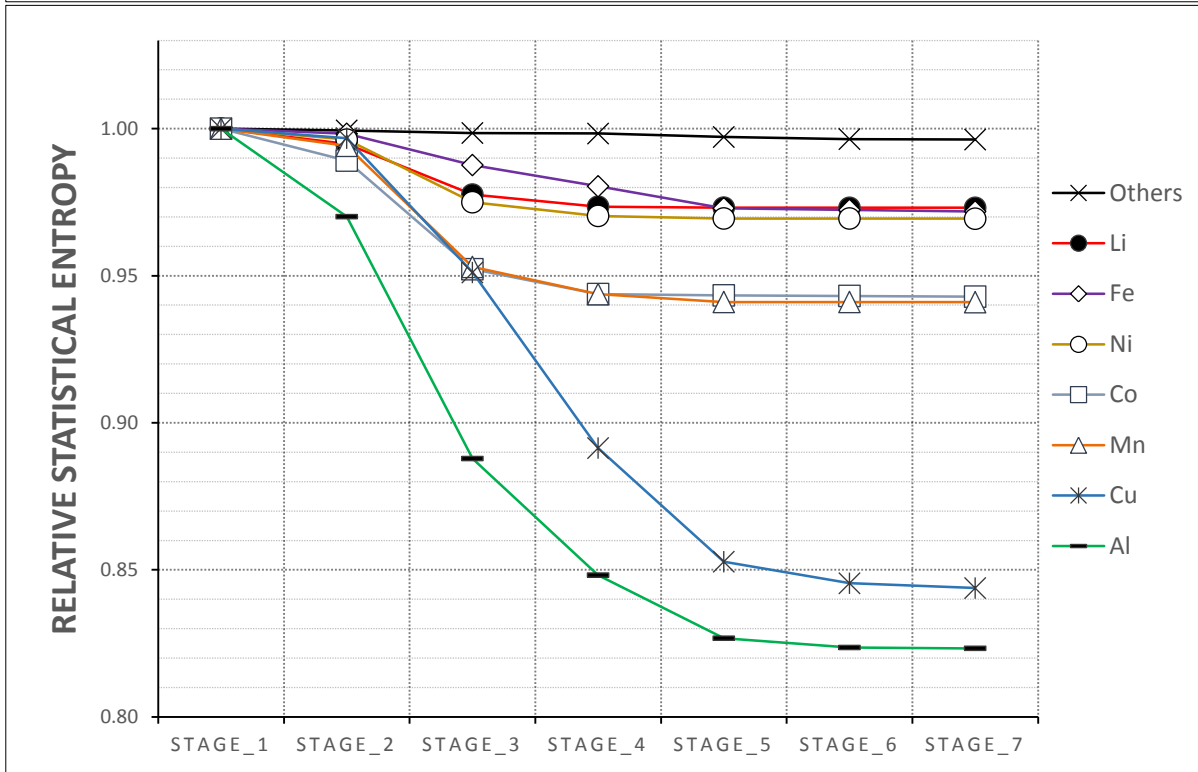
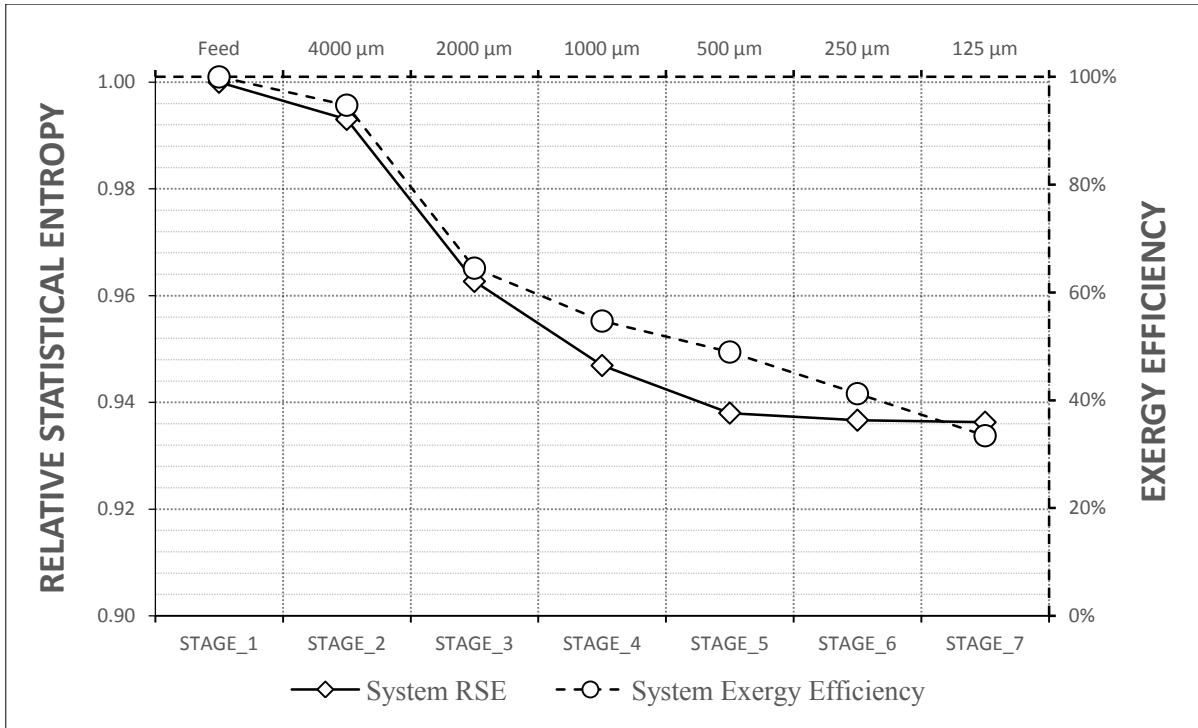


Figure 6 Evolution of: total RSE and Exergy (top), and, RSE per element (bottom) for the original sieving system.

Initially, the negative trend of the total RSE curve (Figure 6, top) reports a concentration action on most of the elements, including Li, Fe, Ni, Co, and, Mn, being Al and Cu the elements with greatest concentration action. Basing the analysis uniquely on the separability curve (Figure 5) such conclusion would be limited for Al and Cu. Figure 6 (bottom) depicts

1 two sections with a plateau-like behavior, according to the RSE analysis these stages reflect a
2 low or no-concentration action, i.e. before Stage_2, and after Stage_5. It is important to
3 notice that based on the separability curve, no further separation may have been proposed
4 beyond the 1000 μm . Thus, optimizing based solely on the separability curve would have
5 effectively discarded the additional concentration provided by an additional sieving stage.
6
7 Furthermore, as observed by comparing Figures 5 and 6, elements equally distributed along
8 the different fractions leads to a quasi-unchanged RSE, being the case of the *Others*. Hence,
9 the slight decrease in RSE value in the *Others* stream can be explained by the mathematical
10 influence of the rest of the elements, with special influence by the abrupt and low RSE
11 progression of the Al and Cu curves.
12
13
14
15
16
17

18
19 The top section of Figure 6 includes the exergy analysis for the sieving system. It is observed
20 that the system uses the energy efficiently at initial stages, yielding an efficiency of 95% at
21 the 4000 μm sieve (Stage_2). In further stages the exergy efficiency gradually lowers to a
22 33% value at the 125 μm sieve (Stage_7), going through an inflection point at Stage_3.
23
24 During the initial stages of the system, i.e. Stage_1 to Stage_3, the Exergy and RSE behave
25 similar, attributed to the strong influence of the entropy factor on the material chemical
26 exergy. Starting at Stage_3 the exergy efficiency is reduced as the process goes on. Indeed,
27 the reduction of exergy efficiency is due to the systemically increase on the amount of waste
28 streams and the reduction of mass-pull of *useful product*. It is suspected that the weight of the
29 entropy term of the chemical exergy of the *useful product* is reduced in comparison to the
30 same term of the increasing amount of waste streams, irremediably leading to a decrease of
31 exergy efficiency. As seen from the behaviour of ψ in Figure 6, there is no clear point upon
32 which an optimization decision may be based, unlike the above-described plateau behaviour
33 reflected by RSE. As exemplified by this sieving system, exergy analysis does not provide
34 sufficient information, particularly regarding physical separation processes relevant for
35 recycling.
36
37
38
39
40
41
42
43
44
45
46
47

48
49 As seen, Figure 6 shows that only Al presents any significant concentration action before
50 Stage_2, and there is a minimum contribution to the concentration action for all the elements
51 after Stage_5. Therefore, it is reasonable to suggest the removal of processes 1, 5 and 6 (i.e.,
52 4000, 250 and 125 μm , respectively) of the original sieving system. RSE and ψ of such
53 modified process is shown in Figure 7.
54
55
56
57
58
59
60
61
62
63
64
65

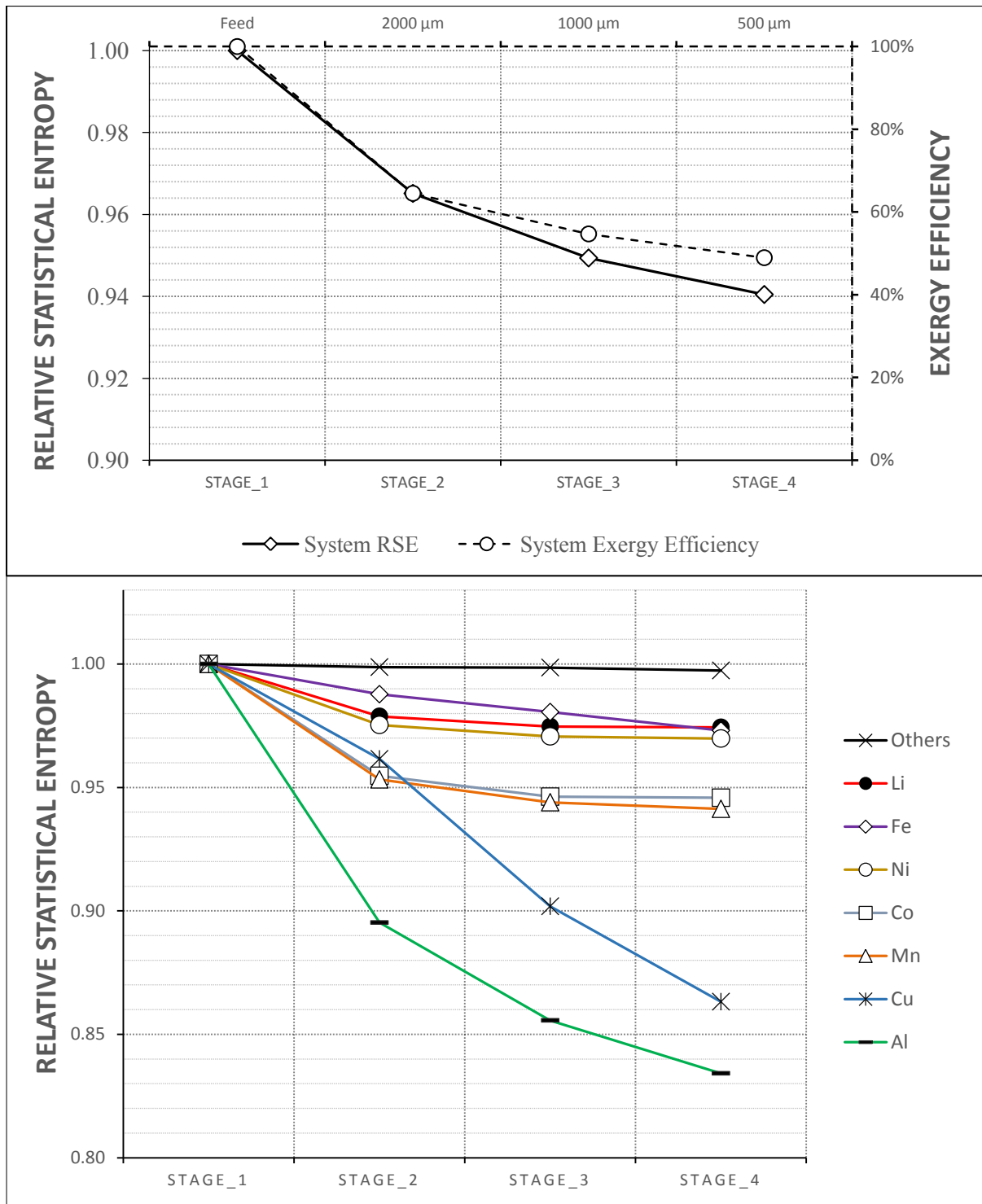


Figure 7 Evolution of: total RSE and Exergy (top), and, RSE per element (bottom) for the modified sieving system.

Upon comparison of Figures 6 and 7, the system optimization becomes evident as every single process remaining shows a significant concentration action in both systemic and elemental levels. Admittedly, a change in the final RSE value is presented due to change in concentration of components. Indeed, as seen from the bottom section of Figure 7, the final

1 value of the RSE is slightly higher than in the original system. Thus, the modified process has
2 a lower overall entropy reduction, hence lower concentration action in comparison to the
3 original system. Nevertheless, this difference is minor and, thus, the modification sustains.
4 The modified process presents clear advantages in comparison to the original, as the
5 continuous decrease of total RSE value reflects a more efficient use of each separation
6 process, while a diminished number of stages can be translated in lower processing costs
7 and/or lower capital expenditure.
8

9
10
11
12
13 On the other hand, the exergy efficiency of the modified system (dotted line in Figure 7),
14 presents the same trend to decrease efficiency as the system evolves. Nevertheless, the exergy
15 value at the final stage is considerably higher compared to the last stage of the original
16 system, i.e., 49% versus 33%. Hence, it is possible to conclude from the exergy efficiency
17 perspective that a process with lower amount of physical separations processes (stages)
18 becomes more efficient utilizing the available energy. Nevertheless, Figure 7 (top)
19 reiteratively presents no point for process optimization from the exergy efficiency
20 perspective, illustrating the need for a parameter such as RSE.
21
22
23
24
25
26
27

28 3.2.1 Process Specific RSE: Information Gain

29 A further use of the RSE methodology is the analysis of *Information Gain (IG)* as a specific
30 parameter of the concentration action executed per process, defined in Equation 12 as the
31 difference in RSE between two consecutive stages, q , and, $q-1$:
32
33
34
35

$$36 \quad IG_{Process} = RSE_{i,q} - RSE_{i,q-1} \quad (12)$$

37
38 The Information Gain permits the identification of processes which contribute in a higher or
39 lower manner to the concentration effect. This value grants a numerical value, intrinsically
40 linked to the process and throughput, which reflects in a sound and engineering way the
41 efficiency of each separation step. Thus, IG, can be used to support design decisions, as
42 presented in Section 3.2, or as a design parameter to improve a single element recovery, as it
43 describes the interaction between an element and a process. Figure 8 presents the IG chart of
44 the system using Cu as an illustrative example.
45
46
47
48
49
50
51
52
53
54
55
56
57
58
59
60
61
62
63
64
65

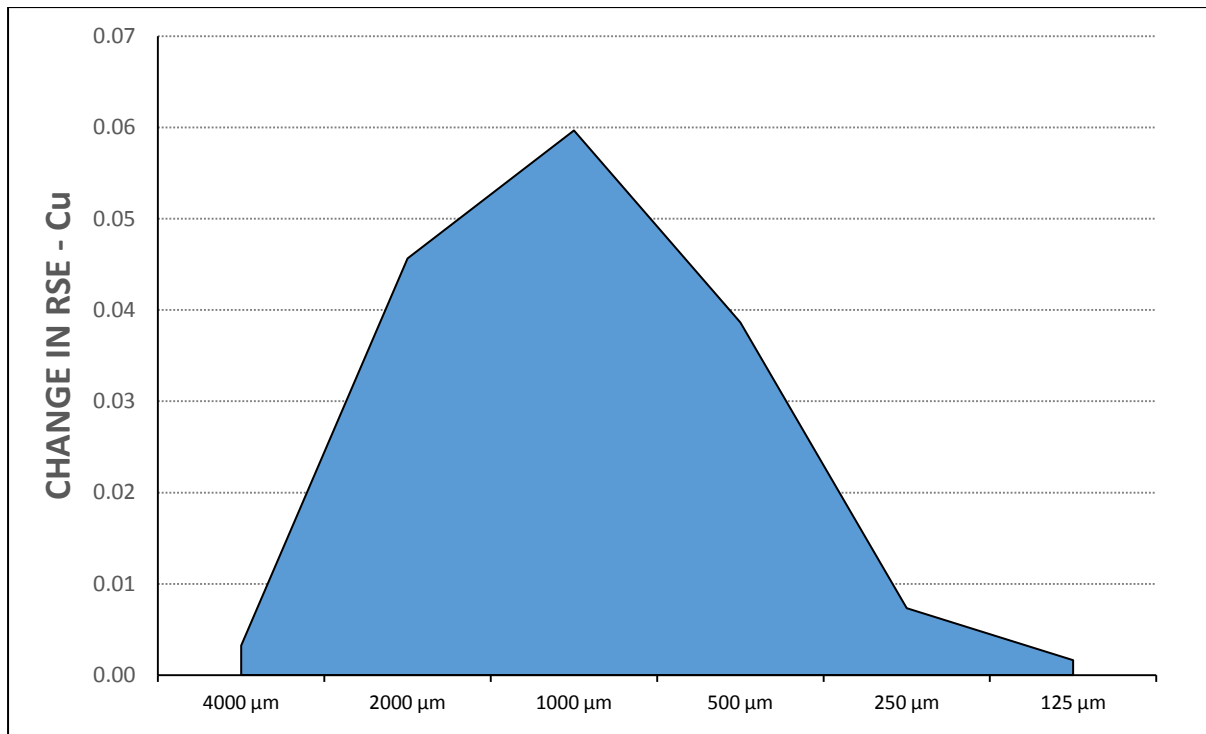


Figure 8 Reduction of RSE per sieve in the Cu stream (original system).

Initially, the RSE curve for Cu, shown in Figure 8, shows a steep concentrating action in just three out of the six steps from the original separation system, located at the middle size sieves of the system under study. This correspond to the stages with lower SCE values depicted in Figures 6 and 7. This further supports the use of a process consisting of only three sieving processes, 2000μm, 1000μm and 500μm sieves for the concentration of Cu.

3.3 Proposed Methodology

The results obtained exemplify the idea of optimization based on RSE, particularly in cases where exergy analysis does not provide clear parameters for optimization. The following methodology is proposed as guideline for recycling process design or recycling process optimization:

1. Definition of the system boundaries
2. Determination of the mass flow and composition of each stream
3. Plot node-stage diagram of the system.
4. Calculation of the RSE and SCE values and plot RSE-vs-Stage diagram.
 - 4.1. Identify processes with low or negative concentration action
 - 4.2. Evaluate IG to identify with increased certainty the processes that may represent a bottleneck in the reduction of RSE.
5. Calculate RSE, IG and SCE of the modified system for validation

5.1. Perform or discard changes upon the result of RSE and SCE

Ideally, an efficient concentration system should present a relative small number of processing steps with steep negative slopes in the RSE-vs-Stage diagram, reflecting a strong concentration trend.

4 Conclusions and Future Work

The current work presents the application of RSE methodology for process optimization using the sieving of crushed LIB waste as a proof-of-concept. The discussed approach aims to cover the gaps present in exergy analysis with the aim of offering parameters to analyze recycling processes in a systemic manner and bring them closer to a circular economy philosophy. Even though the exergy analysis has gained a wide acceptance, as shown in this work, this approach may encounter some limitations in the analysis of physical separation processes. The combination of RSE and MFA provides a methodology that allows the analysis of a system from its capacity to concentrate materials, thus offering an alternative parameter upon which to base design and optimization decisions. Moreover the results obtained by applying RSE and MFA to a system, reflect the influence of past processing stages upon the final recoveries. From the perspective of circular economy, this methodology provides a value that weights on the importance to the pre-processing stages (e.g. sieving) on the recovery of materials. Traditional decision-making on recycling technologies are focused only on the quality of a final product and its associated market value, while overlooking the losses of potentially useful material in waste and side streams. Being a parameter that penalizes such material losses, it is expected that RSE-MFA analysis will help to demonstrate the advantages of technologies where potentially valuable materials in LIBs are recovered, even when this implies a larger number of processing stages.

As seen in this proof-of-concept, the clear trends presented by RSE as a function of sieving stages offered means upon which an optimized system was modeled, offering a reduced number of sieving steps with a minimal impact on the final concentration of materials. This work sets the ground to include an additional parameter, i.e. statistical entropy, for the analysis, design and optimization of material processing systems. In combination with MFA, this approach takes a holistic view of the separation systems that, unlike other efficiency parameters, includes products and side streams. Indeed, depending on the limits set for the processing system, the RSE values produced with the methodology hereby proposed will influence the system from the pre-processing steps down to pyro- and hydrometallurgical

refining. Thus, RSE is an engineering parameter that can support decision-making in favor of a CE.

Although the recycling of LIB is an interesting application of this methodology, RSE analysis is by no means limited to this example. It is also expected that the approach presented is not exclusive to mechanical processing operations and could be applied to entire recycling systems, including mechanical processing, pyro- and hydrometallurgical operations. Due to the complexity of industrial recycling systems, the implementation of RSE analysis may require the support of digital tools such as HSC-Sim®. Furthermore, the application of RSE as hereby discussed augments the work on the thermo-economic (exergetic) analysis of larger systems by (Abadías Llamas et al., 2018). In such work significant parts of the CE are simulated in the HSC-Sim® platform, obtaining simultaneous analyses of exergy and energy flows, material recovery, life cycle analysis, capital expenditure (CAPEX) and operational expenditure (OPEX). This implies that product design can be linked to metal recovery, hence, make a fundamental assessment of product design and Circular Economy performance. RSE and MFA can be added to this suite of indicators obtained by HSC-Sim® in order to not only capture the chemical and physical exergy of a system but also to link them to the Shannon entropy of particulate parts within CE systems (Reuter et al., 2015; Van Schalkwyk et al., 2017). Based on the results of this proof-of-concept, and the availability of process simulation tools, it may be worth pursuing the analysis of complex systems by simulation-based RSE and MFA in future studies by researchers and practitioners in the field of raw materials production.

5 Supporting Information

The detailed calculations steps and values for RSE, and Exergy can be found in the Supporting Information.

6 Acknowledgments

The research hereby presented was supported by the METYK-project (grant number 3254/31/2015), funded by Finnish innovation agency (TEKES), as well as the “Closing the loop for high-added value materials (CloseLoop)” project supported by the Academy of Finland. Severi Ojanen is acknowledged for his contribution on the experimental sieving of the LIB samples.

7 Reviewed Literature

- 1
2
3 Abadías Llamas, A., Valero Delgado, A., Valero Capilla, A., Torres Cuadra, C., Hulgren, M.,
4 Peltomäki, M., Roine, A., Reuter, M.A., 2018. Simulation-based exergy, thermo-
5 economic and environmental footprint analysis of primary copper production. *Miner.*
6 *Eng.*
7
8
9
10 Abadías Llamas, A., Valero Delgado, A., Valero Capilla, A., Torres Cuadra, C., Hultgren,
11 M., Peltomäki, M., Roine, A., Stelter, M., Reuter, M.A., 2019. Simulation-based exergy,
12 thermo-economic and environmental footprint analysis of primary copper production.
13 *Miner. Eng.* 131, 51–65. <https://doi.org/10.1016/j.mineng.2018.11.007>
14
15
16
17
18 Al-Thyabat, S., Nakamura, T., Shibata, E., Iizuka, A., 2013. Adaptation of minerals
19 processing operations for lithium-ion (LiBs) and nickel metal hydride (NiMH) batteries
20 recycling: Critical review. *Miner. Eng.* 45, 4–17.
21
22 <https://doi.org/10.1016/j.mineng.2012.12.005>
23
24
25
26 Amini, S.H., Remmerswaal, J.A.M., Castro, M.B., Reuter, M.A., 2007. Quantifying the
27 quality loss and resource efficiency of recycling by means of exergy analysis. *J. Clean.*
28 *Prod.* 15, 907–913. <https://doi.org/10.1016/j.jclepro.2006.01.010>
29
30
31
32 Bai, L., Qiao, Q., Li, Y., Wan, S., Xie, M., Chai, F., 2015. Statistical entropy analysis of
33 substance flows in a lead smelting process. *Resour. Conserv. Recycl.* 94, 118–128.
34
35 <https://doi.org/10.1016/j.resconrec.2014.11.011>
36
37
38
39 Balibrea, F., 2016. On Clausius , Boltzmann and Shannon Notions of Entropy 219–227.
40
41 Beer, F.P., Johnston, R., DeWolf, J., Mazurek, D., 2012. *Mechanics of Materials*, 6th ed,
42 *Mechanics of Materials*. McGraw Hill, New York.
43
44
45 Bharani, B., Praveen Prakash, A., 2015. Optimization of multiproduct economic production
46 quantity problem with stochastic constraints using sequential quadratic programming.
47 *Knowledge-Based Syst.* 12, 98–107. <https://doi.org/10.1016/j.knosys.2015.04.001>
48
49
50
51 Brunner, P.H., Rechberger, H., 2011. *Practical Handbook of Material Flow Analysis*,
52 *Complete Casting Handbook*. Lewis Publishers.
53
54
55
56 Cengel, Y. a, Boles, M. a, 2015. *Thermodynamics: An Engineering Approach*, 8th ed.
57 *McGraw Hill*, New York.
58
59
60
61
62
63
64
65

- 1
2
3
4
5
6
7
8
9
10
11
12
13
14
15
16
17
18
19
20
21
22
23
24
25
26
27
28
29
30
31
32
33
34
35
36
37
38
39
40
41
42
43
44
45
46
47
48
49
50
51
52
53
54
55
56
57
58
59
60
61
62
63
64
65
- Diekmann, J., Hanisch, C., Frob, L., Sch, G., Loellhoeffel, T., Kwade, A., 2017. Ecological Recycling of Lithium-Ion Batteries from Electric Vehicles with Focus on Mechanical Processes 164, 6184–6191. <https://doi.org/10.1149/2.0271701jes>
- Duan, C., Deng, C., Gharaei, A., Wu, J., Wang, B., 2018. Selective maintenance scheduling under stochastic maintenance quality with multiple maintenance actions. *Int. J. Prod. Res.* 7543, 1–19. <https://doi.org/10.1080/00207543.2018.1436789>
- Ellen MacArthur Foundation, 2013. *Towards the Circular Economy*, Ellen MacArthur Foundation. <https://doi.org/10.1162/108819806775545321>
- European Commission, 2014. *Taking Stock of the Europe 2020 Strategy for Smart, sustainable and Inclusive Growth*. Brussels.
- Friends of the Earth, 2013. *Less is more: Resource Efficiency through waste collection, recycling and reuse of...*
- Georgi-Maschler, T., Friedrich, B., Weyhe, R., Heegn, H., Rutz, M., 2012. Development of a recycling process for Li-ion batteries. *J. Power Sources* 207, 173–182. <https://doi.org/10.1016/j.jpowsour.2012.01.152>
- Gharaei, A., Pasandideh, S.H.R., 2017. Modeling and optimization of four-level integrated supply chain with the aim of determining the optimum stockpile and period length: sequential quadratic programming. *J. Ind. Prod. Eng.* 34, 529–541. <https://doi.org/10.1080/21681015.2017.1370742>
- Gharaei, A., Pasandideh, S.H.R., 2016. Modeling and Optimization the Four-Level Integrated Supply Chain : Sequential Quadratic Programming. *Int. J. Comput. Sci. Inf. Secur.* 14, 650–669.
- Gharaei, A., Pasandideh, S.H.R., Akhavan Niaki, S.T., 2018. An optimal integrated lot sizing policy of inventory in a bi-objective multi-level supply chain with stochastic constraints and imperfect products. *J. Ind. Prod. Eng.* 35, 6–20. <https://doi.org/10.1080/21681015.2017.1374308>
- Gharaei, A., Pasandideh, S.H.R., Khamseh, A.A., 2017. Inventory model in a four-echelon integrated supply chain: modeling and optimization. *J. Model. Manag.* 12, 739–762. <https://doi.org/http://dx.doi.org/10.1108/MRR-09-2015-0216>
- Goonetilleke, D., Faulkner, T., Peterson, V.K., Sharma, N., 2018. Structural evidence for Mg-

- 1 doped LiFePO₄ electrode polarisation in commercial Li-ion batteries. *J. Power Sources*
2 394, 1–8. <https://doi.org/10.1016/j.jpowsour.2018.05.024>
3
- 4 Gutowski, T.G., 2011. Materials Separation and Recycling, in: Bakshi, B.R., Gutowski, T.G.,
5 Sekulic, D.P. (Eds.), *Thermodynamics and the Destruction of Resources*. Cambridge
6 University Press, pp. 113–132.
7
- 8 Gutowski, T.G., 2008. Thermodynamics and Recycling, A review. *IEEE Int. Symp. Electron.*
9 *Environ.* 1–5. <https://doi.org/10.1109/ISEE.2008.4562912>
10
- 11 Gutowski, T.G., Sekulic, D.P., 2011. Thermodynamic Analysis of Resources Used in
12 Manufacturing Processes, in: *Thermodynamics and the Destruction of Resources*.
13 Cambridge University Press, New York, pp. 163–189.
14
- 15 Hailey, P., Kepler, K., 2015. *Direct Recycling Technology for Plug-In electric Vehicle*
16 *Lithium-Ion Battery Packs*. California.
17
- 18 Heelan, J., Gratz, E., Zheng, Z., Wang, Q., Chen, M., Apelian, D., Wang, Y., 2016. Current
19 and Prospective Li-Ion Battery Recycling and Recovery Processes. *J. Miner. Met.*
20 *Mater. Soc.* 68, 2632–2638. <https://doi.org/10.1007/s11837-016-1994-y>
21
- 22 Ignatenko, O., van Schaik, A., Reuter, M.A., 2007. Exergy as a tool for evaluation of the
23 resource efficiency of recycling systems. *Miner. Eng.* 20, 862–874.
24 <https://doi.org/10.1016/j.mineng.2007.03.005>
25
- 26 Julien, C.M., Mauger, A., Zaghbi, K., Groult, H., 2014. Comparative Issues of Cathode
27 Materials for Li-Ion Batteries. *Inorganics* 2, 132–154.
28 <https://doi.org/10.3390/inorganics2020132>
29
- 30 Kotas, T.J., 1995. *The exergy method of thermal plant analysis*. Krieger Publishing
31 Company, Florida.
32
- 33 Laner, D., Zoboli, O., Rechberger, H., 2017. Statistical entropy analysis to evaluate resource
34 efficiency: Phosphorus use in Austria. *Ecol. Indic.* 83, 232–242.
35 <https://doi.org/10.1016/j.ecolind.2017.07.060>
36
- 37 Linden, D., Reddy, B.T. (Eds.), 2011. *Linden's Handbook of Batteries*, Fourth Edition,
38 Fourth. ed. McGraw Hill, New York.
39
- 40 Nitta, N., Wu, F., Lee, J.T., Yushin, G., 2015. Li-ion battery materials: Present and future.
41
42
43
44
45
46
47
48
49
50
51
52
53
54
55
56
57
58
59
60
61
62
63
64
65

Mater. Today 18, 252–264. <https://doi.org/10.1016/j.mattod.2014.10.040>

1
2
3
4
5
6
7
8
9
10
11
12
13
14
15
16
17
18
19
20
21
22
23
24
25
26
27
28
29
30
31
32
33
34
35
36
37
38
39
40
41
42
43
44
45
46
47
48
49
50
51
52
53
54
55
56
57
58
59
60
61
62
63
64
65

Pillot, C., 2016. The Rechargeable Battery Market and Main Trends 2014-2025. Adv. Automot. Batter. Conf.

Pistoia, G. (Ed.), 2014. Lithium-Ion Batteries Advances and Applications, First. ed. Elsevier B.V, Oxford. <https://doi.org/http://dx.doi.org/10.1016/B978-0-444-59513-3.00001-7> ?

Porvali, A., Aaltonen, M., Ojanen, S., Velazquez-Martinez, O., Eronen, E., Liu, F., Wilson, B.P., Serna-Guerrero, R., Lundström, M., 2019. Mechanical and hydrometallurgical processes in HCl media for the recycling of valuable metals from Li-ion battery waste. Resour. Conserv. Recycl. In Press.

Rechberger, H., Brunner, P.H., 2002. A new, entropy based method to support waste and resource management decisions. Environ. Sci. Technol. 36, 809–16. <https://doi.org/Doi10.1021/Es010030h>

Rechberger, H., Graedel, T.E., 2002. The contemporary European copper cycle: Statistical entropy analysis. Ecol. Econ. 42, 59–72. [https://doi.org/10.1016/S0921-8009\(02\)00102-7](https://doi.org/10.1016/S0921-8009(02)00102-7)

Reuter, M.A., van Schaik, A., Gediga, J., 2015. Simulation-based design for resource efficiency of metal production and recycling systems: Cases - copper production and recycling, e-waste (LED lamps) and nickel pig iron. Int. J. Life Cycle Assess. 20, 671–693. <https://doi.org/10.1007/s11367-015-0860-4>

Scott, A., 2017. Metal prices challenge battery sector. Chem. Eng. News 95, 21–23.

Shannon, C.E., 1948. A Mathematical Theory of Communication. Bell Syst. Tech. J. 27, 379–423.

Sobantka, A.P., Thaler, S., Zessner, M., Rechberger, H., 2014. Extended statistical entropy analysis for the evaluation of nitrogen budgets in Austria. Int. J. Environ. Sci. Technol. 11, 1947–1958. <https://doi.org/10.1007/s13762-013-0401-2>

Sobhanallahi, M.A., Gharaei, A., Pilbala, M., 2016. Provide a practical approach for measuring the performance rate of organizational strategies. Proc. 12th Int. Conf. Ind. Eng. ICIE 2016 115–124. <https://doi.org/10.1109/INDUSENG.2016.7519357>

Swain, B., 2017. Recovery and recycling of lithium: A review. Sep. Purif. Technol. 172,

388–403. <https://doi.org/10.1016/j.seppur.2016.08.031>

1
2 U.S. Department of the Interior, U.S. Geological Survey, 2017. Mineral Commodity
3 Summaries 2017. <https://doi.org/https://doi.org/10.3133/70180197>.

4
5
6
7 Van Schalkwyk, R.F., Reuter, M., Gutzmer, J., Stelter, M., 2017. Challenges of digitalizing
8 the circular economy : Assessment of the state-of-the-art of metallurgical carrier metal
9 platform for lead and its associated technology elements. *J. Clean. Prod.* 186, 585–601.
10
11 <https://doi.org/10.1016/j.jclepro.2018.03.111>

12
13
14 Wang, X., Gaustad, G., Babbitt, C.W., Richa, K., 2014. Economies of scale for future
15 lithium-ion battery recycling infrastructure. *Resour. Conserv. Recycl.*
16
17 <https://doi.org/10.1016/j.resconrec.2013.11.009>

18
19
20
21 Waters, C.N., Zalasiewicz, J., Summerhayes, C., Barnosky, A.D., Poirier, C., Galuszka, A.,
22 Cearreta, A., Edgeworth, M., Ellis, E.C., Ellis, M., Jeandel, C., Leinfelder, R., McNeill,
23 J.R., Richter, D. d., Steffen, W., Syvitski, J., Vidas, D., Wagnreich, M., Williams, M.,
24 Zhisheng, A., Grinevald, J., Odada, E., Oreskes, N., Wolfe, A.P., 2016. The
25 Anthropocene is functionally and stratigraphically distinct from the Holocene. *Science*
26
27 (80-.). 351, 137–148. <https://doi.org/10.1126/science.aad2622>

28
29
30
31
32
33 Wieser, H., Tröger, N., 2016. Exploring the inner loops of the circular economy:
34 Replacement, repair, and reuse of mobile phones in Austria. *J. Clean. Prod.* 172, 3042–
35 3055. <https://doi.org/10.1016/j.jclepro.2017.11.106>

36
37
38
39 Zhang, T., He, Y., Ge, L., Fu, R., Zhang, X., Huang, Y., 2013. Characteristics of wet and dry
40 crushing methods in the recycling process of spent lithium-ion batteries. *J. Power*
41
42
43
44
45
46
47
48
49
50
51
52
53
54
55
56
57
58
59
60
61
62
63
64
65
Sources 240, 766–771. <https://doi.org/10.1016/j.jpowsour.2013.05.009>

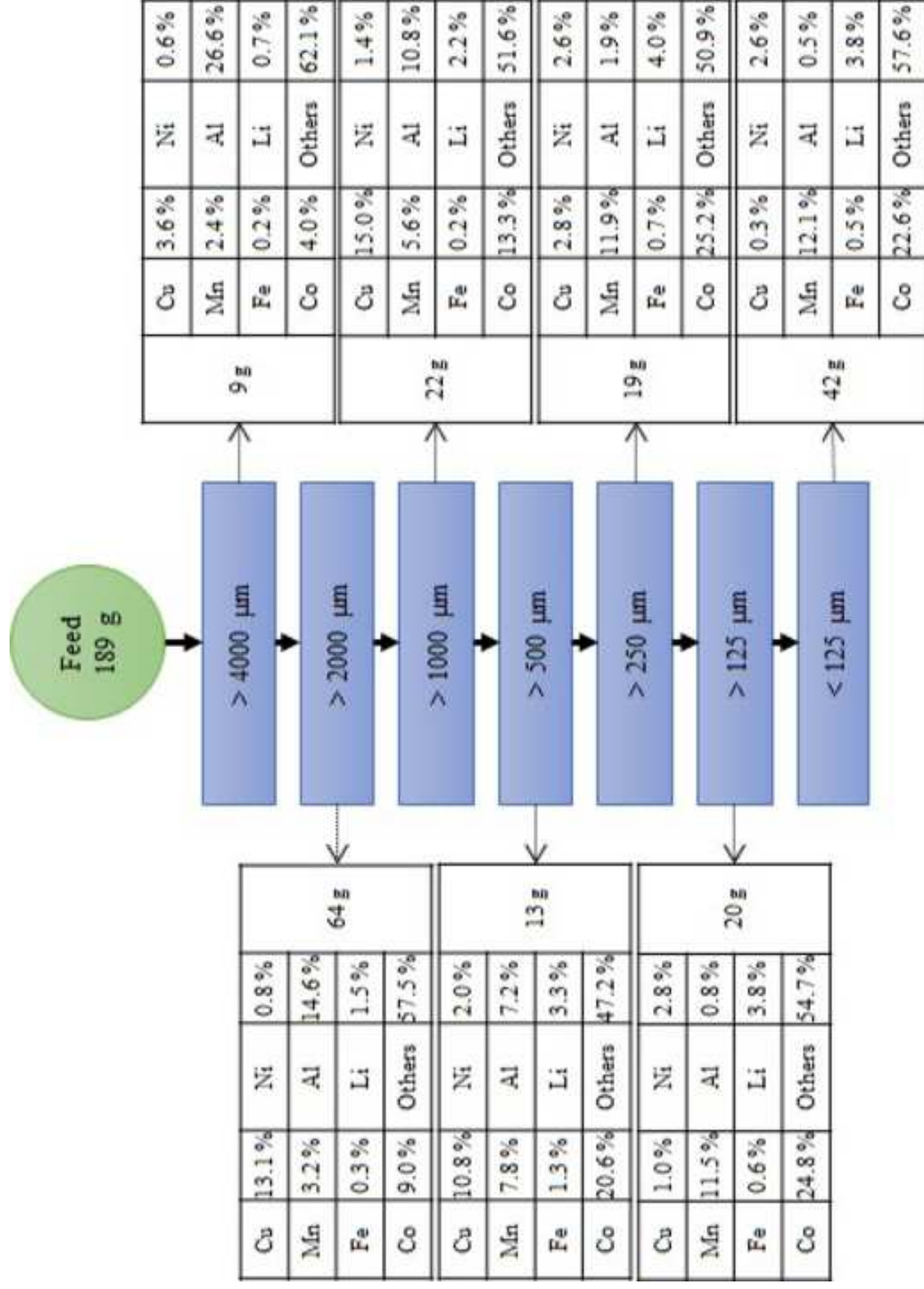
List of Symbols

1		
2	Symbol	
3	$h_{i,s}$	Statistical entropy of the i^{th} component in the s^{th} stream
4	$\tilde{m}_{i,s}$	Standardized mass fraction
5	\dot{X}_i	Total substance flow induced by i^{th} component.
6	$H_{i,q}$	Total statistical entropy of the i^{th} component in the q^{th} stage
7	$H_{i,q}^{max}$	Maximum level of entropy of the i^{th} component in the q^{th} stage
8	RSE_q^{total}	Total relative statistical entropy
9	k	Total group of components
10		
11	$SCE_{i,input-output}$	Substance concentration efficiency of the i^{th} element between any
12		input and output.
13	$IG_{Process}$	Information Gain of a process
14	n_i	Number of moles of the component i
15	e_i	Specific chemical exergy of the component i
16	R	Universal gas constant = 8.3144 J/mol*K
17	T_0	Environmental temperature
18	n	Total number of moles in the fraction
19	x_i	Molar fraction of the component i .
20	ψ	Exergetic efficiency
21	$E_{products}$	Exergy of the products
22	E_{input}	Exergy of the input material
23	$E_{Oversize}$	Exergy of the oversize material
24	$E_{Undersize}$	Exergy of the undersize material
25	E_{Feed}	Exergy of the fed material
26	$E_{Electricity}$	Exergy added in the form of energy to power the sieve
27		
28		
29		
30		
31		
32		
33		
34		
35		
36		
37		
38		
39		
40		
41		
42		
43		
44		
45		
46		
47		
48		
49		
50		
51		
52		
53		
54		
55		
56		
57		
58		
59		
60		
61		
62		
63		
64		
65		

Figure
[Click here to download high resolution image](#)

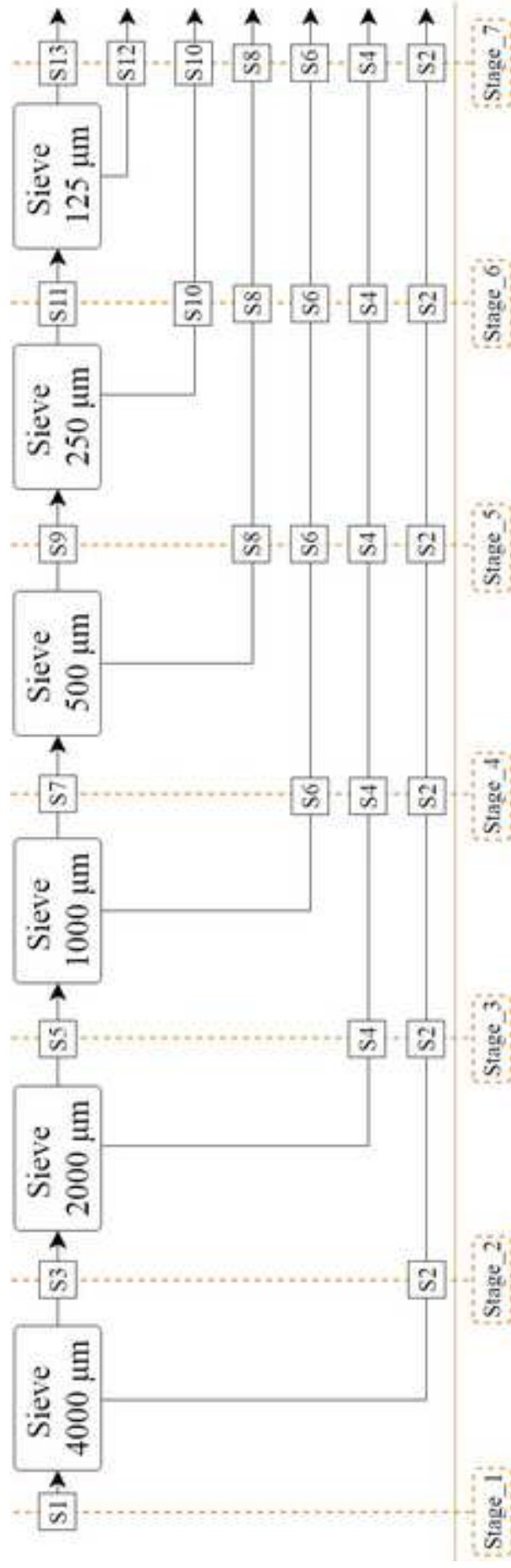


Figure
[Click here to download high resolution image](#)



Figure

[Click here to download high resolution image](#)



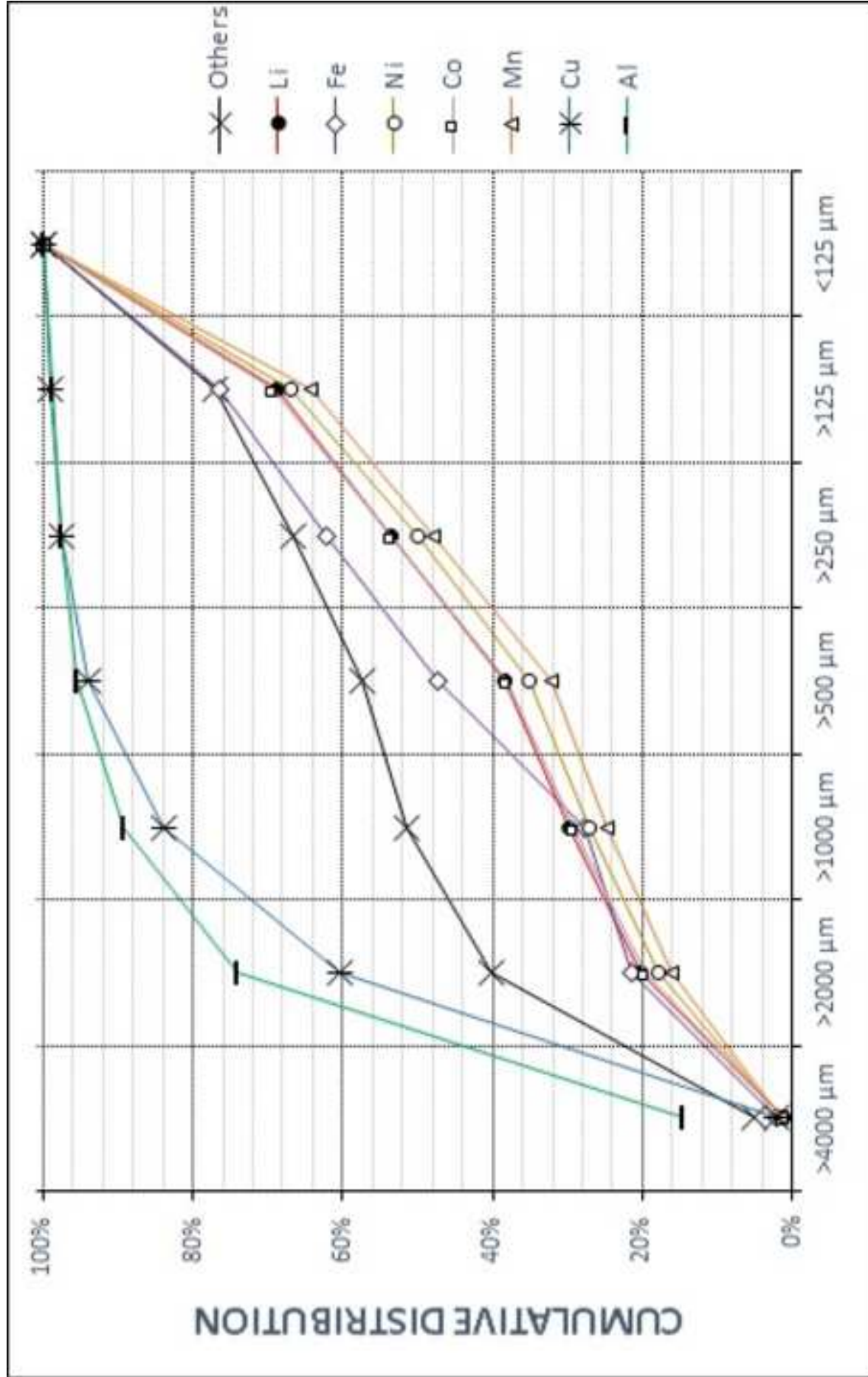


Figure [Click here to download high resolution image](#)

Figure
[Click here to download high resolution image](#)

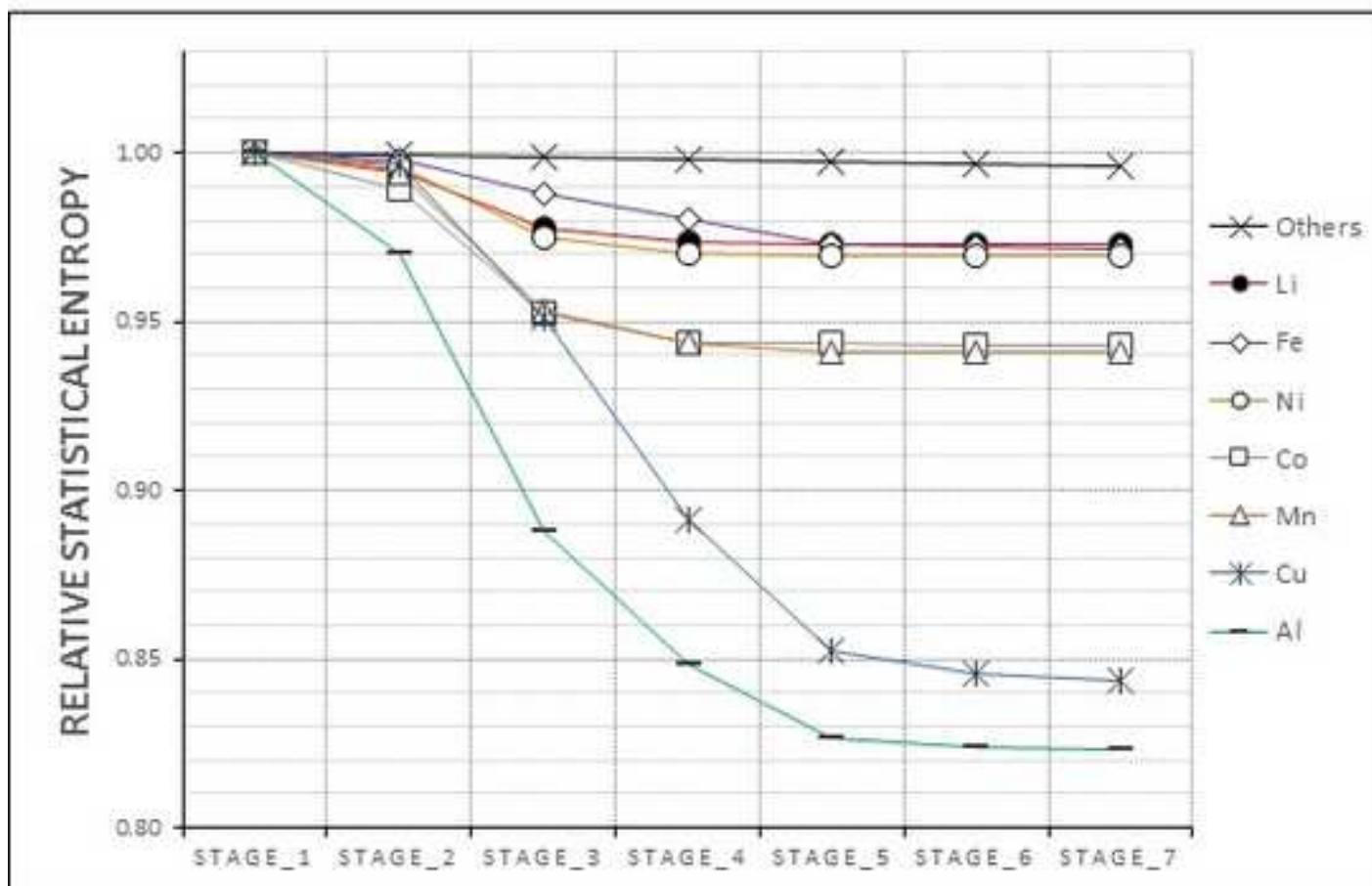
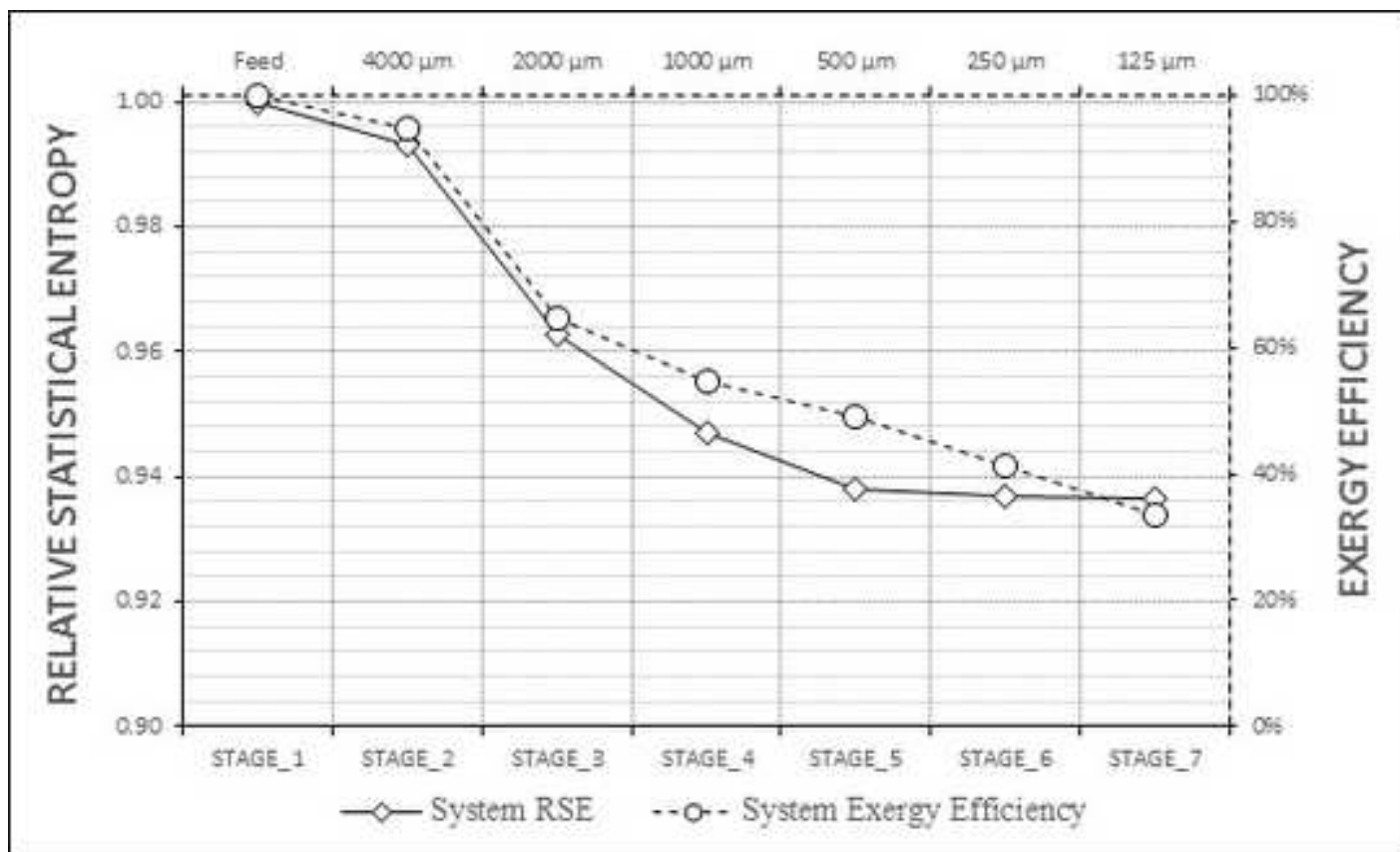


Figure
[Click here to download high resolution image](#)

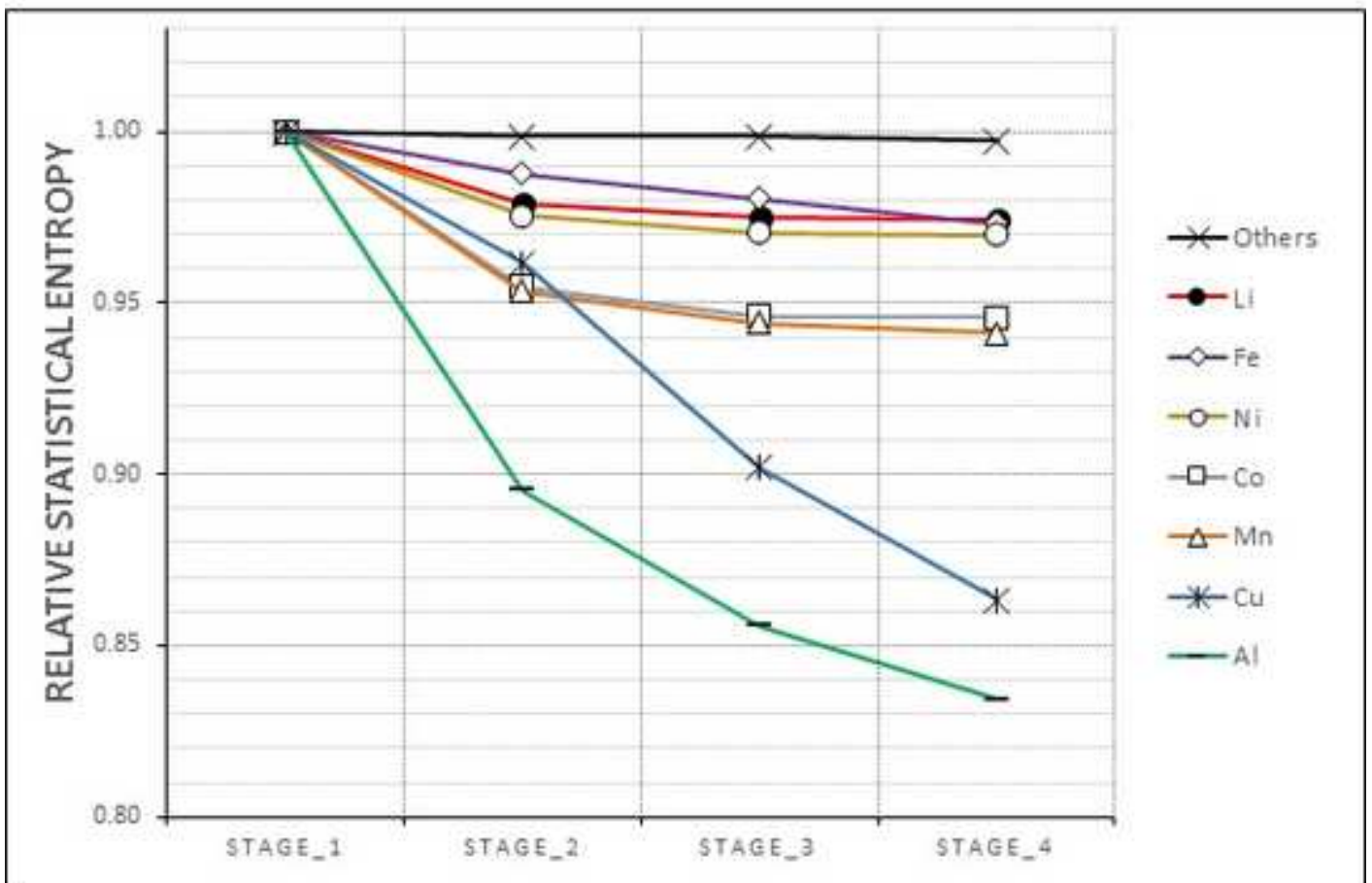
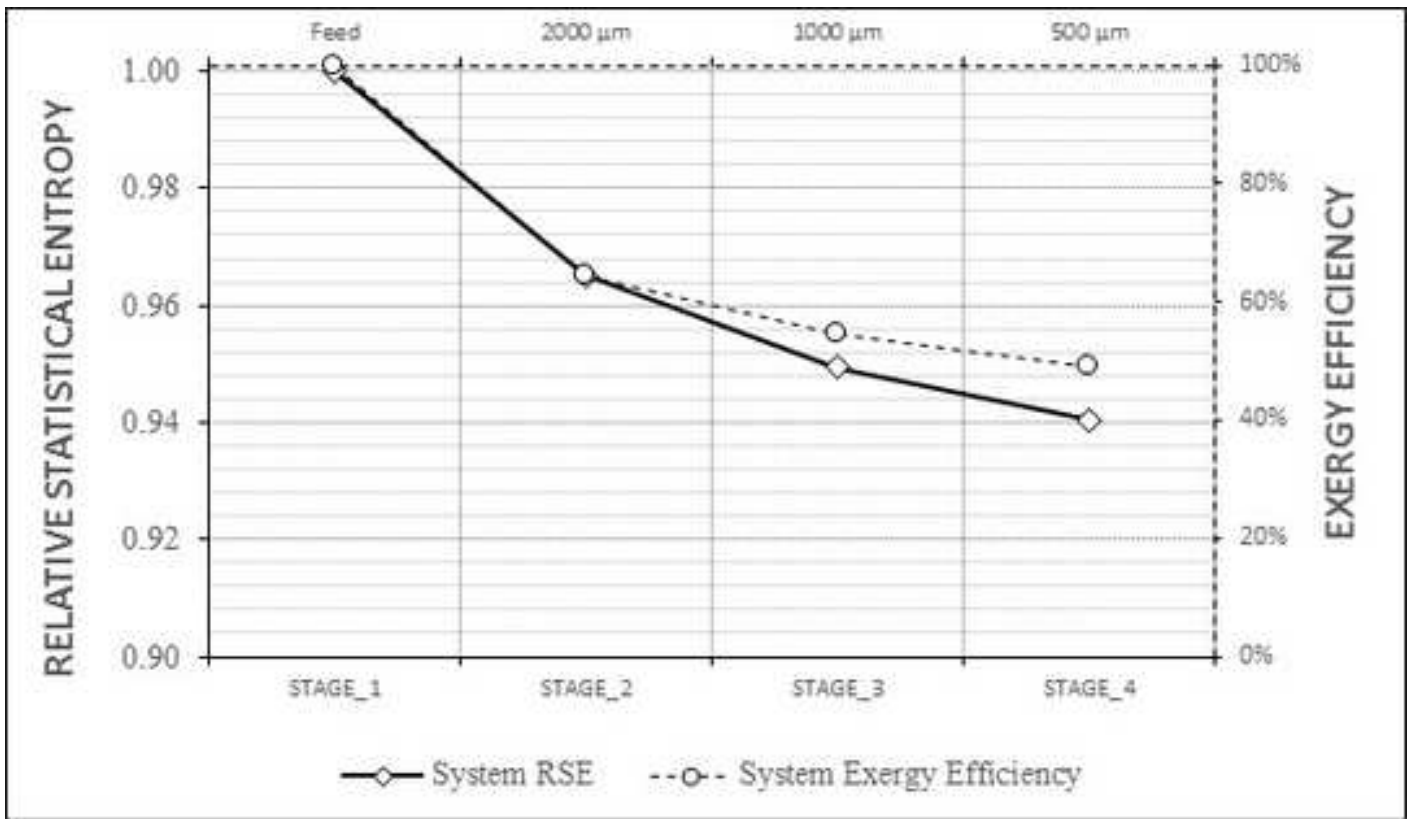
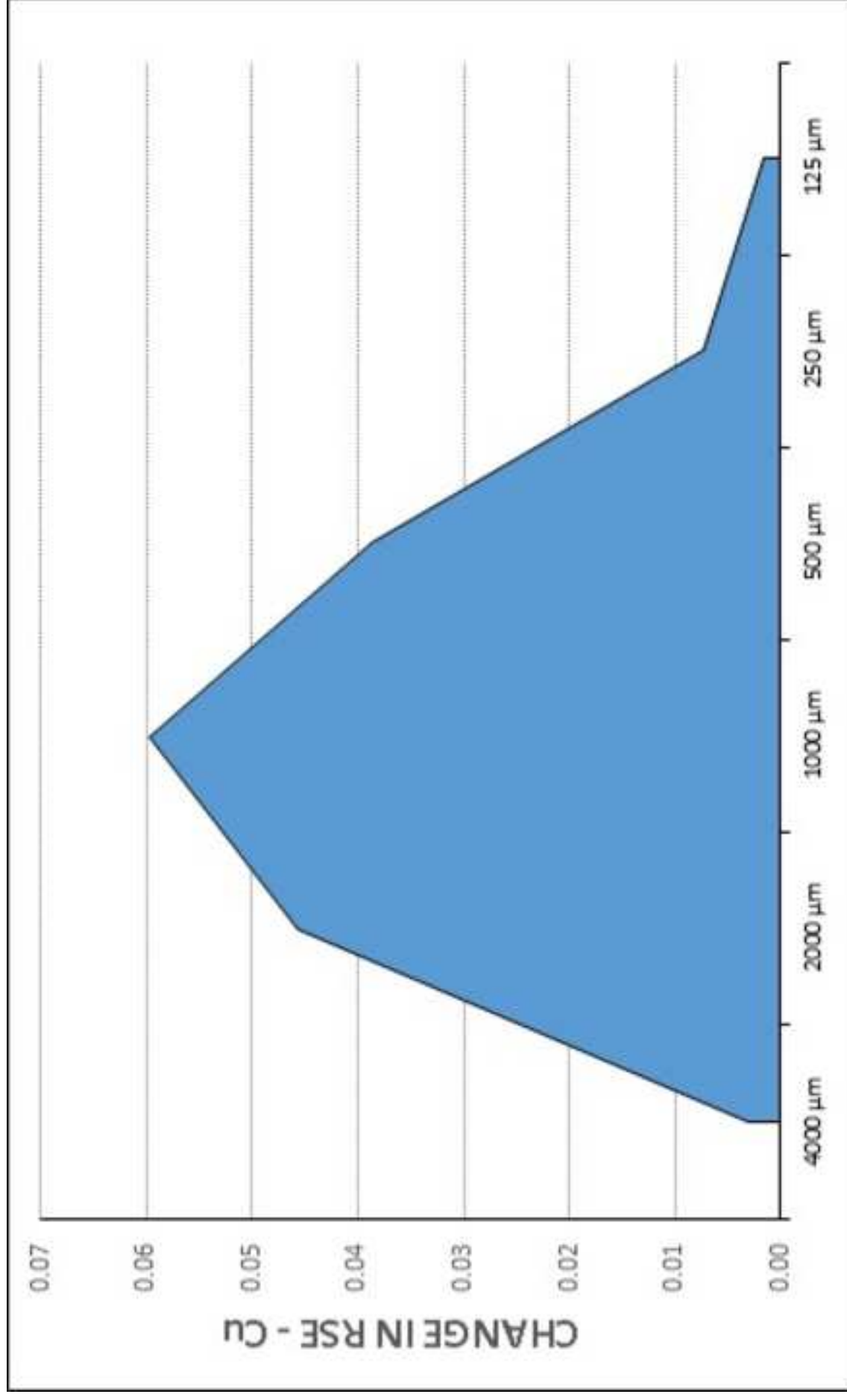


Figure
[Click here to download high resolution image](#)



Abstract

With the concept of circular economy gaining strength as an alternative for the sustainable production of raw materials, there is an inherent need to develop methods capable of quantifying the efficiency of recycling systems, provide guidelines for optimization of existing technologies, and support the design of new products based on sound, scientific and engineering principles. The work hereby presented proposes the use of statistical entropy coupled with material flow analysis as a basis for the optimization of separation and purification processes. Unlike other efficiency parameters, this approach provides an analysis of component concentration or dilution from a systemic perspective, taking into consideration products, by-products and waste streams. As a proof-of-concept, a sieving process for waste lithium-ion batteries (LIB¹) was chosen. It is demonstrated that using this approach it is possible to determine the stages that do not contribute to the concentration of components thus offering guidelines for process optimization. In the present case, the total number of sieving stages can be decreased with a minimum impact on the concentration of the products. In comparison, it is also shown that the widely accepted exergy analysis is not able to identify the opportunities for optimization due to the particular characteristics of this exemplary system, i.e., negligible change in energy consumption as a function of sieving stages and absence of chemical changes. Finally, the experimental results suggest that Al and Cu can be concentrated using a simple sieving pre-processing step, perhaps in preparation for a subsequent refining stage.

¹ Lithium ion battery

Supplementary File

[Click here to download Supplementary File: Complementary_material.xlsx](#)

TO UNDERSTAND THE OVERALL ENTROPIC BEHAVIOUR OF THE SEIVING SYSTEM

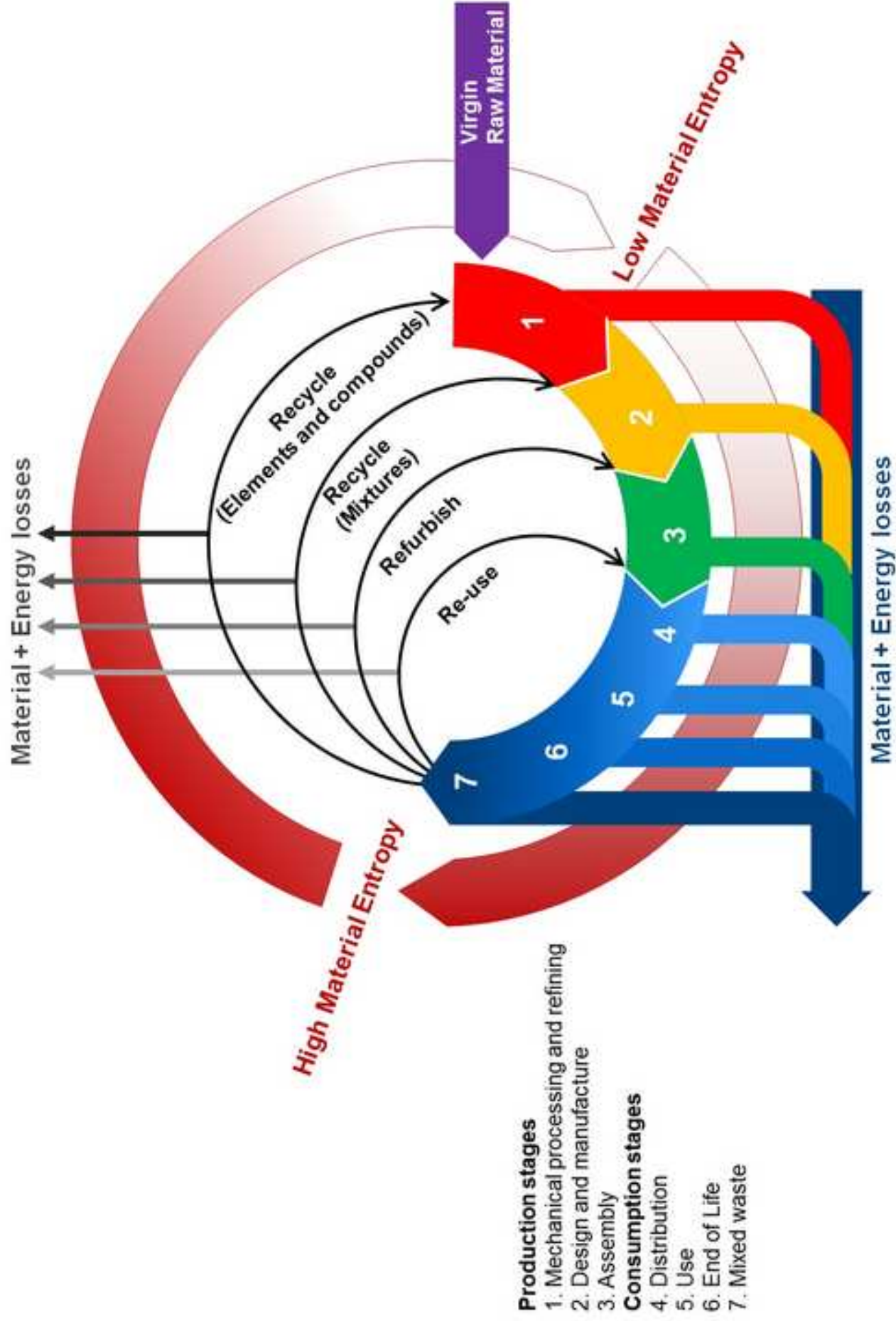
	k	No. Goods:	j=1			
		1.0000	Stage 1_FEED			
			F1-input	ci	mi	
7.5904	1.0000	F1-input	Cu	14.3413	0.0759	188.9400
7.4857	2.0000	FLOW (m1)	Mn	14.1435	0.0749	188.9400
0.4526	3.0000	188.9000	Fe	0.8551	0.0045	188.9400
16.3927	4.0000		Co	30.9724	0.1639	188.9400
1.7340	5.0000		Ni	3.2763	0.0173	188.9400
8.3348	6.0000		Al	15.7479	0.0833	188.9400
2.6789	7.0000		Li	5.0614	0.0268	188.9400
55.3308	8.0000		Muut	104.5421	0.5533	188.9400
			188.9400			

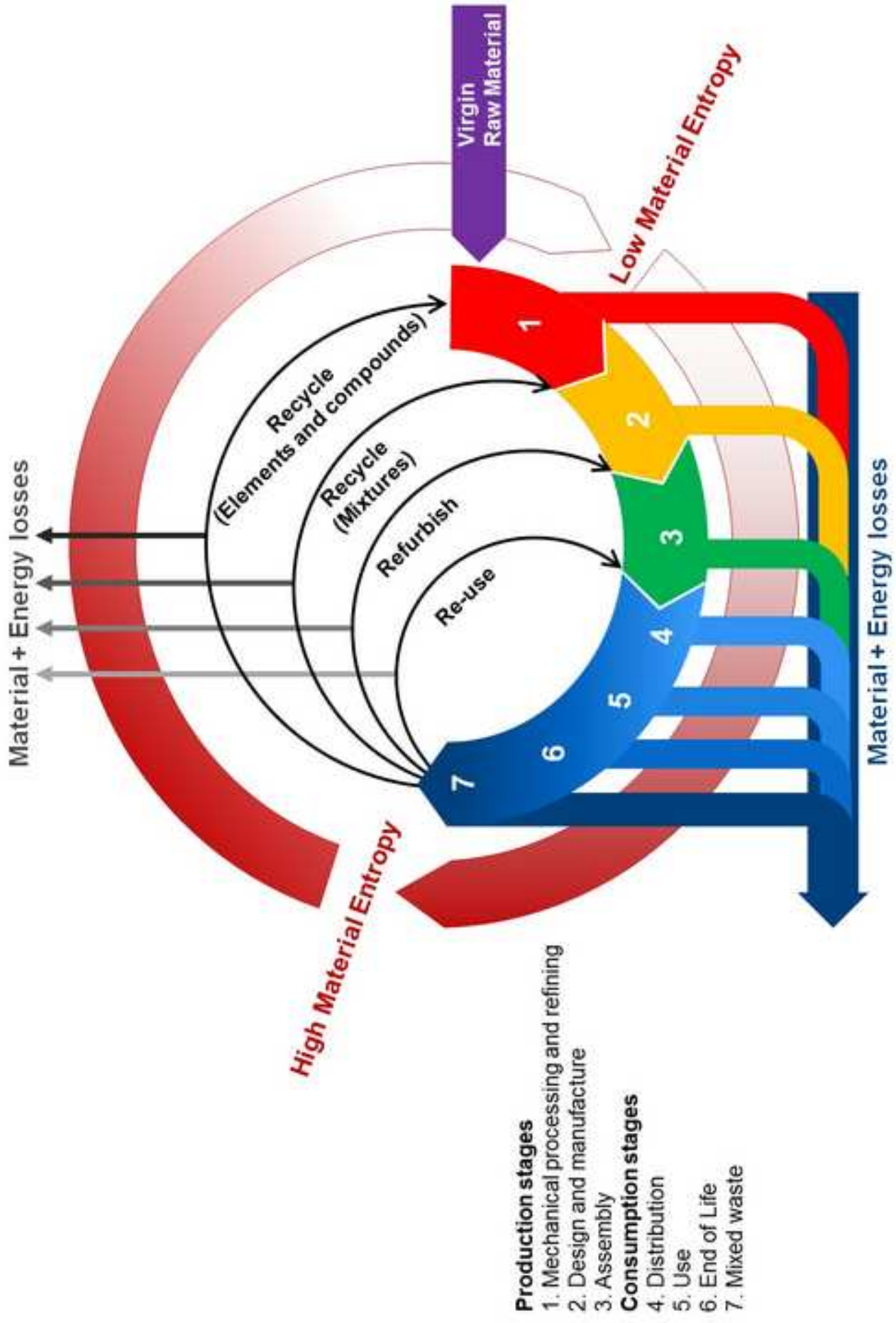
	H_REAL					
Cu	3.7197	3.7076	3.5378	3.3158	3.1720	
Mn	3.7397	3.7179	3.5639	3.5293	3.5194	
Fe	7.7876	7.7741	7.6913	7.6350	7.5769	
Co	2.6089	2.5806	2.4842	2.4622	2.4610	
Ni	5.8497	5.8280	5.7034	5.6762	5.6712	
Al	3.5847	3.4775	3.1827	3.0406	2.9637	
Li	5.2222	5.1951	5.1052	5.0837	5.0820	
Muut	0.8538	0.8533	0.8526	0.8524	0.8514	
	Hmax	Hmax	Hmax	Hmax	Hmax	
Cu	3.7197	3.7197	3.7197	3.7197	3.7197	
Mn	3.7397	3.7397	3.7397	3.7397	3.7397	
Fe	7.7876	7.7876	7.7876	7.7876	7.7876	
Co	2.6089	2.6089	2.6089	2.6089	2.6089	
Ni	5.8497	5.8497	5.8497	5.8497	5.8497	
Al	3.5847	3.5847	3.5847	3.5847	3.5847	
Li	5.2222	5.2222	5.2222	5.2222	5.2222	
Others	0.8538	0.8538	0.8538	0.8538	0.8538	
	33.3664	33.3664	33.3664	33.3664	33.3664	
RSE_TOT	1.0000	0.9930	0.9627	0.9469	0.9380	

	STAGE1	STAGE2	STAGE3	STAGE4	STAGE5
	RSE	RSE	RSE	RSE	RSE
Cu	1.0000	0.9968	0.9511	0.8914	0.8528
Mn	1.0000	0.9942	0.9530	0.9437	0.9411

Figure

[Click here to download high resolution image](#)





Highlights (for review)

- Al and Cu fractions from LIB shredded waste can be recovered by sieving.
- A sieving system was optimized based on statistical entropy.
- The optimized system showed similar concentration action with a shorter process.
- Real process optimization comes from including by-products into the analysis.
- The systemic view of RSE and MFA is necessary to achieve a true circular economy.

Statistical Entropy Analysis as Tool for Circular Economy: Proof of Concept by Optimizing a Lithium-Ion Battery Waste Sieving System

O. Velázquez Martínez ⁽¹⁾, K. G. Van Den Boogaart ⁽²⁾, M. Lundström ⁽¹⁾, A. Santasalo-Aarnio ⁽¹⁾, M. Reuter ⁽²⁾, R. Serna-Guerrero ^{(1)*}

(1) Department of Chemical and Metallurgical Engineering, School of Chemical Engineering, Aalto University, P.O. Box 16200, 00076 Aalto, Finland

(2) Helmholtz Institute Freiberg for Resource Technology, Chemnitzer Str. 40, 09599 Freiberg, Germany

**Correspondence to rodrigo.serna@aalto.fi*

Figure Captions

[Click here to download Supplementary File: Figure_Captions.docx](#)

Figure 1 Circular economy model from a material-centric perspective.

Figure 2 Pictures of representative samples of the LIB waste used in this study (A) overflow and (B) underflow fractions

Figure 3 Flow diagram of the sieving system, including elemental composition at each size fraction

Figure 4 Node-stage diagram of the sieving system

Figure 5 Separability curve of the analyzed LIB components

Figure 6 Evolution of: total RSE and Exergy (top), and, RSE per element (bottom) for the original sieving system.

Figure 7 Evolution of: total RSE and Exergy (top), and, RSE per element (bottom) for the modified sieving system.

Figure 8 Reduction of RSE per sieve in the Cu stream (original system).