

## **Better Together: Ilmenite/Hematite Junctions for Photoelectrochemical Water Oxidation**

Berardi, S.; Kesavan, J. K.; Amidani, L.; Meloni, E. M.; Marelli, M.; Boscherini, F.; Caramori, S.; Pasquini, L.;

Originally published:

October 2020

**ACS Applied Materials and Interfaces 12(2020)42, 47435-47446**

DOI: <https://doi.org/10.1021/acsami.0c12275>

Perma-Link to Publication Repository of HZDR:

<https://www.hzdr.de/publications/Publ-31569>

Release of the secondary publication  
on the basis of the German Copyright Law § 38 Section 4.

**Better Together: Ilmenite/Hematite Junctions  
for Photoelectrochemical Water Oxidation**Serena Berardi, Jagadesh Kopula Kesavan, Lucia Amidani, Elia Marek Meloni,  
Marcello Marelli, Federico Boscherini, Stefano Caramori, and Luca Pasquini*ACS Appl. Mater. Interfaces*, **Just Accepted Manuscript** • DOI: 10.1021/acsami.0c12275 • Publication Date (Web): 28 Sep 2020Downloaded from [pubs.acs.org](https://pubs.acs.org) on September 29, 2020**Just Accepted**

“Just Accepted” manuscripts have been peer-reviewed and accepted for publication. They are posted online prior to technical editing, formatting for publication and author proofing. The American Chemical Society provides “Just Accepted” as a service to the research community to expedite the dissemination of scientific material as soon as possible after acceptance. “Just Accepted” manuscripts appear in full in PDF format accompanied by an HTML abstract. “Just Accepted” manuscripts have been fully peer reviewed, but should not be considered the official version of record. They are citable by the Digital Object Identifier (DOI®). “Just Accepted” is an optional service offered to authors. Therefore, the “Just Accepted” Web site may not include all articles that will be published in the journal. After a manuscript is technically edited and formatted, it will be removed from the “Just Accepted” Web site and published as an ASAP article. Note that technical editing may introduce minor changes to the manuscript text and/or graphics which could affect content, and all legal disclaimers and ethical guidelines that apply to the journal pertain. ACS cannot be held responsible for errors or consequences arising from the use of information contained in these “Just Accepted” manuscripts.

## Better Together: Ilmenite/Hematite Junctions for Photoelectrochemical Water Oxidation

Serena Berardi,<sup>1</sup> Jagadesh Kopula Kesavan,<sup>2</sup> Lucia Amidani,<sup>3</sup> Elia Marek Meloni,<sup>1</sup> Marcello Marelli,<sup>4</sup> Federico Boscherini,<sup>2</sup> Stefano Caramori,<sup>1</sup> Luca Pasquini<sup>2,\*</sup>

1 - Department of Chemical and Pharmaceutical Sciences, University of Ferrara, via L. Borsari 46, 44121 Ferrara, Italy.

2 - Department of Physics and Astronomy, Alma Mater Studiorum – Università di Bologna, viale C. Bertini 6/2, 40127 Bologna, Italy.

3 - Helmholtz-Zentrum Dresden-Rossendorf, c/o European Synchrotron Radiation Facility, 71 Avenue des Martyrs, 38000 Grenoble, France.

4 - CNR-SCITEC, Istituto di Scienze e Tecnologie Chimiche "Giulio Natta", Via G. Fantoli 16/15, 20138 Milano, Italy.

\* corresponding author: luca.pasquini@unibo.it

**Keywords:** Photoelectrochemistry, Hematite, Titanium, EXAFS, Electron Microscopy, Transient Absorption Spectroscopy, Heterointerface, Oxygen Evolution Catalyst

### Abstract

Hematite ( $\alpha\text{-Fe}_2\text{O}_3$ ) is an Earth-abundant indirect n-type semiconductor displaying a band gap of about 2.2 eV, useful for collecting a large fraction of visible photons, with frontier energy levels suitably aligned for carrying out the photoelectrochemical water oxidation reaction under basic conditions. The modification of hematite mesoporous thin film photoanodes with Ti(IV), as well as their functionalization with an oxygen evolving catalyst, leads to a six-fold increase in photocurrent density with respect to the unmodified electrode. In order to provide a detailed understanding of this behavior, we report a study of Ti-containing phases within the mesoporous film structure. Using X-ray absorption fine structure and high-resolution transmission electron microscopy coupled with electron energy loss spectroscopy, we find that Ti(IV) ions are incorporated within ilmenite ( $\text{FeTiO}_3$ ) near-surface layers, thus modifying the semiconductor-electrolyte interface. To the best of our knowledge, this is the first time that a  $\text{FeTiO}_3/\alpha\text{-Fe}_2\text{O}_3$  composite is used in a photoelectrochemical set-up for water oxidation. In fact, previous studies of Ti(IV)-modified hematite photoanodes reported the formation of pseudobrookite ( $\text{Fe}_2\text{TiO}_5$ ) at the surface.

By means of transient absorption spectroscopy, transient photocurrent experiments, and electrochemical impedance spectroscopy, we show that the formation of the  $\text{Fe}_2\text{O}_3/\text{FeTiO}_3$  interface passivates deep traps at the surface and induce a large density of donor levels, resulting in a strong depletion field that separates electron and holes, favoring hole injection in the electrolyte.

1  
2  
3 Our results provide the identification of a phase coexistence with enhanced  
4 photoelectrochemical performance, allowing for the rational design of new photoanodes with  
5 improved kinetics.  
6  
7

## 8 9 **1. Introduction**

10  
11 The need to find solutions to the global energy crisis has prompted the scientific community  
12 to propose various approaches aimed at the exploitation of renewable energy sources. Among  
13 them, solar energy conversion in the form of chemical energy (so-called artificial photosynthesis)  
14 can be effectively realized in photoelectrochemical cells (PECs). In such devices, the illumination of  
15 semiconductor-based materials triggers several complex charge separation processes, leading to  
16 the formation of energy-rich molecules, also known as solar fuels.<sup>1,2</sup> One of the most investigated  
17 alternative fuels, hydrogen, can be obtained at the cathodic side of a PEC system for photoinduced  
18 water splitting, while at the anodic side oxygen evolves.<sup>3,4</sup> In order to realize optimized composite  
19 photoelectrodes it is of paramount importance to gain a thorough understanding of the physical  
20 properties of commonly used materials as well as to investigate new ones.  
21  
22  
23  
24  
25  
26  
27  
28

29 In particular, in this work we use advanced spectroscopic and electrochemical techniques in  
30 order to shed light on the interfacial composition and the charge transfer dynamics of Ti(IV)-  
31 modified hematite films with enhanced PEC performance.  
32  
33  
34

35 The photoanodic platform of choice, i.e. hematite ( $\alpha$ -Fe<sub>2</sub>O<sub>3</sub>), is widely used in PEC-based  
36 systems,<sup>5,6</sup> thanks to: (i) its intermediate band gap (*ca.* 2.2 eV), allowing for the absorption of visible  
37 photons up to 590 nm; (ii) the valence band maximum favorably located with respect to the  
38 potential of the H<sub>2</sub>O/O<sub>2</sub> redox couple; (iii) the essentially null toxicity; (iv) the good chemical stability  
39 in aqueous alkaline media; and (v) its abundance, leading to low cost. However, the  
40 photoelectrochemical performance of hematite is limited by the low mobility of charge carriers and  
41 the slow hole transfer to the electrolyte.<sup>5</sup> These detrimental aspects are generally addressed using  
42 strategies involving doping, nanostructuring and the functionalization with catalytic layers, or a  
43 combination thereof.<sup>5</sup>  
44  
45  
46  
47  
48  
49  
50

51 In our work, Ti(IV) was chosen as the dopant agent since it is reported to increase the electron  
52 density and the overall conductivity of the resulting material,<sup>7</sup> as well as to passivate hematite  
53 surface states.<sup>7,8</sup> All these aspects contribute to extend the lifetime of the charge carriers, reducing  
54 their recombination, and improving the photocurrent. However, the actual origin of the Ti-induced  
55 improvement of the PEC performance remains elusive to date. We thus use X-ray Absorption Fine  
56 Structure (XAFS) and high-resolution transmission electron microscopy (HR-TEM) as powerful tools  
57  
58  
59  
60

1  
2  
3 to study the local atomic and electronic structure of condensed matter. Detailed analysis of the fine  
4 structure oscillations in the extended energy range (the so – called EXAFS: Extended X-ray  
5 Absorption Fine Structure) based on the real – space multiple scattering formalism is able to provide  
6 a quantitative determination of the composition of the first few coordination shells around the  
7 excited atom, the interatomic distances and their spread around the average value. Moreover,  
8 analysis of the lineshape of the spectral region near the absorption edge (so – called XANES: X-ray  
9 Absorption Near Edge Structure) can provide important information on the oxidation state, valence,  
10 atomic geometry and site/symmetry selected density of states (DOS) of unoccupied electronic  
11 states. Due to its local character, XAFS is particularly useful to study disordered or defective atomic  
12 arrangements in condensed matter, including especially thin films. Also very important for the  
13 present investigation, XAFS is the premier structural tool to determine the incorporation site of  
14 dopants in condensed matter since it is possible in many cases to isolate the XAFS cross – section of  
15 the excited atom from the background contribution.<sup>9,10,11</sup> The objectives of the XAFS measurements  
16 in the present case were to assess the possible modification of the hematite matrix upon addition  
17 of Ti and to determine the incorporation sites. Concerning the second point, we sought to determine  
18 whether Ti is found in a local structure reminiscent of one of the Ti oxides, as an isolated Ti impurity  
19 substitutional to Fe or as in ilmenite, an Fe – Ti mixed oxide, or in any other form. The spatial  
20 distribution of Ti containing phases within the mesoporous thin films was determined by TEM  
21 equipped with Electron Energy Loss Spectroscopy (EELS), which provides information  
22 complementary to XAFS together with the high spatial resolution typical of TEM.  
23  
24  
25  
26  
27  
28  
29  
30  
31  
32  
33  
34  
35  
36  
37  
38  
39

40 At the same time, we employ transient absorption spectroscopy (TAS), transient photocurrent  
41 (TPC) experiments, and electrochemical impedance spectroscopy (EIS), in order to evaluate the  
42 effect of the interfacial modifications on the collection and recombination dynamics of the  
43 photogenerated charges, involving the participation of different kinds of surface states. It has  
44 recently been pointed out that this is a critical (and often overlooked) issue for the operation of  
45 hematite-based photoanodes for PEC water oxidation, which can be usefully engineered and  
46 exploited.<sup>12</sup>  
47  
48  
49  
50  
51

52 Our work thus provides spectroscopic and photoelectrochemical insights enabling to unravel  
53 the role of Ti(IV) and catalytic layers on the performance of composite hematite electrodes, as well  
54 as to rationally design new photoanodes with optimized kinetics.  
55  
56  
57

## 58 **2. Experimental methods**

59 The photoanodes were prepared by depositing mesoporous hematite thin films (300-400  
60

1  
2  
3 nm thick, indicated as MPH) on fluorine-doped tin oxide (FTO) slides following an easy-to-scale  
4 electrophoretic method.<sup>13,14</sup> When the preparation is made in the presence of a given amount of  
5 dissolved Ti(IV) butoxide (nominal Ti content of 5 and 10 wt%), Ti-modified MPH\_5Ti and MPH\_10Ti  
6 electrodes are respectively obtained. Detailed information on the procedure is provided in the  
7 Supporting Information (SI). Some of the MPH\_5Ti photoanodes were further functionalized with  
8 an amorphous iron oxyhydroxide oxygen evolving catalyst (FeOEC) deposited by Successive Ionic  
9 Layer Adsorption and Reaction (SILAR), as previously reported in conjunction with different  
10 absorbing materials.<sup>13,15,16,17</sup> These electrodes are named MPH\_5Ti-FeOEC throughout the  
11 manuscript.  
12  
13

14  
15  
16  
17  
18  
19  
20  
21  
22  
23  
24  
25  
26  
27  
28  
29  
30  
31  
32  
33  
34  
35  
36  
37  
38  
39  
40  
41  
42  
43  
44  
45  
46  
47  
48  
49  
50  
51  
52  
53  
54  
55  
56  
57  
58  
59  
60

Photoelectrochemical measurements were carried out with a PGSTAT 30 electrochemical workstation in a three-electrode configuration, using a saturated calomel electrode (SCE) and a Pt wire as reference and counter electrodes, respectively. A LOT-Oriel solar simulator, equipped with an AM1.5G filter and set to 0.1 W/cm<sup>2</sup> incident irradiance power, was used as the illumination source. J-V curves were recorded at 20 mV/s scan rate.

For the Electrochemical Impedance Spectroscopy (EIS) measurements under illumination, the photoanodes were sampled in the selected potential range at 50 mV intervals, employing a FRA2.v10 frequency response analyzer controlled by software Nova 1.10. A 10 mV amplitude sinusoidal perturbation, the frequency of which ranged between 100 kHz and 0.1 Hz, was used. The EIS data were fitted by means of the equivalent circuit reported in Figure S13D using the ZView software, with typical relative errors lower than 15%.

Nanosecond Transient Absorption Spectroscopy (TAS) was carried out using pump pulses with 355 nm wavelength and ca. 500 μJ/cm<sup>2</sup> fluence. The spectra were collected both under open-circuit potential  $V_{OC}$  and under anodic bias in a two-electrode configuration using a Pt wire as a counter electrode. Transient photocurrent (TPC) experiments were performed under the same excitation conditions, with the photoanodes placed in a three-compartment cell. TPC measurements were also conducted under a white light bias from a solar simulator set to 0.4 W/cm<sup>2</sup>. Further details on the experimental setup for transient measurements are provided in the SI.

All experiments were performed in a 0.1 KOH aqueous electrolyte (pH 13.3). Unless otherwise stated, the potential values are given versus the reversible hydrogen electrode (RHE), applying the following conversion:

$$V, \text{ vs RHE (V)} = V, \text{ vs SCE (V)} + 0.24 + 0.059 \cdot \text{pH} \quad (1)$$

1  
2  
3 XAFS measurements were carried out at the Ti and Fe K-edges at BM23 of the European  
4 Synchrotron Radiation Facility (ESRF), Grenoble. Measurements on Ti-modified MPH were  
5 performed in fluorescence mode using a Vortex Si drift diode detector placed in the horizontal plane  
6 at right angles to the impinging beam, at room temperature. Reference powder samples of  
7 hematite, magnetite, rutile, anatase, brookite, ilmenite and pseudobrookite were also measured in  
8 transmission mode. The pre-treatment process for all XAFS spectra was performed using the Athena  
9 program of IFEFFIT software package.<sup>18</sup> The pre-edge features were fitted with Gaussian profiles  
10 using the Fityk package.<sup>19</sup> The EXAFS spectra were analysed using the Artemis code<sup>18</sup> using  
11 simulated scattering paths calculated using FEFF 6.0.

12  
13  
14  
15  
16  
17  
18  
19  
20  
21  
22  
23  
24  
25  
26  
27  
28  
29  
30  
31  
32  
33  
34  
35  
36  
37  
38  
39  
40  
41  
42  
43  
44  
45  
46  
47  
48  
49  
50  
51  
52  
53  
54  
55  
56  
57  
58  
59  
60  
TEM analyses were conducted on specimens prepared by scratching the photoanodes  
surface with a scalpel and collecting the powder by adherence onto a copper TEM grid coated by a  
holey carbon film.<sup>20</sup> The employed instrument was a ZEISS LIBRA200 FE electron microscope  
equipped with an in-column  $\Omega$ -filter analyzer. ESI (Electron Spectroscopy Imaging) elemental maps  
for Ti and Fe were collected at the  $L_{2,3}$  edge (at energy loss 462 eV and 708 eV, respectively) by a 3-  
windows methods. EELS (Electron Energy Loss Spectroscopy) spectra were collected at Ti  $L_{2,3}$  edge  
in the energy loss range 420-500 eV. Electron diffraction analysis were performed by CrystBox  
software.<sup>21</sup>

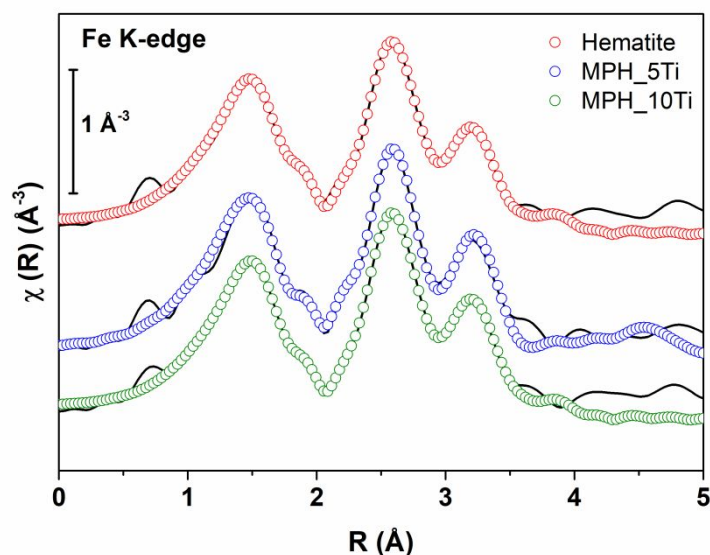
### 3. Results and discussion

The photoelectrochemical performance of the photoanodes, collected under 1 sun  
illumination (0.1 W/cm<sup>2</sup>, AM1.5G) in 0.1 M KOH, are reported in Figure S1A. The results confirm a  
4-fold improvement of the maximum photocurrent density for the MPH\_5Ti electrodes (up to 1  
mA/cm<sup>2</sup> at 1.67 V vs RHE - unless otherwise stated, all the potential values are given versus the  
reversible hydrogen electrode) with the respect to the bare MPH. A decrease in the photoanodic  
performance was instead observed for a higher (or lower) Ti(IV) amount.<sup>13</sup> The functionalization of  
the MPH\_5Ti electrodes with FeOEC resulted, as expected, in a further enhancement of the PEC  
outcomes both in terms of onset (ca. 200 mV shift, Figure S1A) and of net photocurrent (up to 1.45  
mA/cm<sup>2</sup> at 1.67 V), thanks to improved photohole trapping in the catalyst's reactive sites, as  
previously demonstrated by electrochemical impedance spectroscopy (EIS) measurements.<sup>13,16,17</sup>  
Furthermore, by means of Mott-Schottky analysis, we have detected a 3-fold increase in the donor  
density for MPH\_5Ti (and MPH\_5Ti-FeOEC) versus the bare MPH, likely due to the formation of a  
junction between hematite and a Ti-containing phase.<sup>13</sup> However, the exact identification of the

1  
2  
3 local structure of this phase could not be determined neither by X-ray photoemission spectroscopy  
4 (XPS) nor by X-ray diffraction (XRD).<sup>13</sup> XPS shows that the oxidation states of Fe and Ti are 3+ and  
5 4+, respectively. However, this does not allow to distinguish between different Ti-containing phases  
6 like TiO<sub>2</sub> (rutile, anatase or brookite), FeTiO<sub>3</sub>, and Fe<sub>2</sub>TiO<sub>5</sub>. In order to provide an in-depth  
7 understanding of the origin of the enhanced PEC performance of these modified photoanodes, the  
8 local structure and oxidation state of Fe and Ti has been studied by XAFS and TEM-EELS.  
9  
10  
11  
12  
13  
14  
15

### 16 ***XAFS and TEM measurements on the photoanodes***

17  
18 The background subtracted Fe K-edge EXAFS spectra of MPH\_5Ti and MPH\_10Ti and  
19 reference hematite are reported in Figure S2. It is clear that the spectra are all very similar to each  
20 other. Hematite has trigonal crystal structure with spacegroup 167 (i.e. R $\bar{3}$ c:H) in which each Fe  
21 atom is found in a distorted octahedron formed by six O ones (three atoms at 1.93 Å and three at  
22 2.08 Å). Figure 1 shows as continuous lines the Fourier Transforms of the EXAFS spectra performed  
23 in the range 3 - 13.9 Å<sup>-1</sup>. These spectra were fitted in R -space in the range 1 - 4.8 Å using the known  
24 structure of hematite to calculate scattering paths.  
25  
26  
27  
28  
29  
30  
31  
32



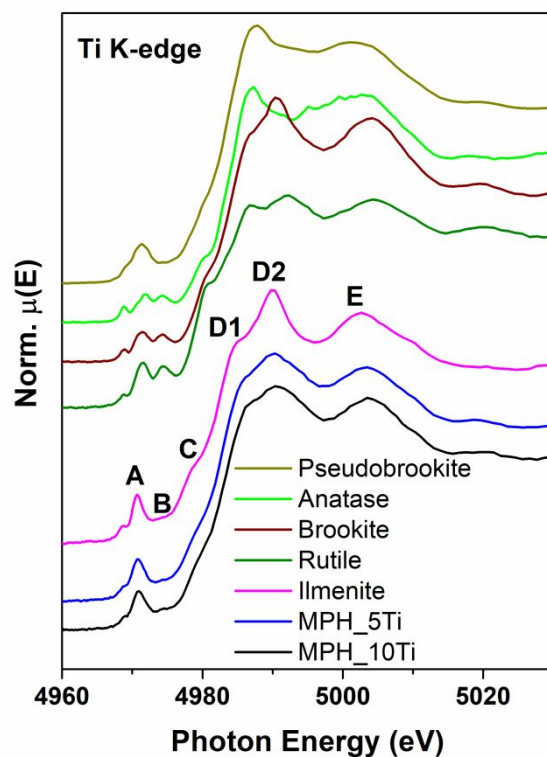
**Figure 1.** Fourier-transformed Fe K edge EXAFS ( $k^2$  weighted) spectra of Ti-modified MPH and reference hematite with their best fits (data reported as continuous line and fits as empty circles). Spectra have been vertically offset for clarity.



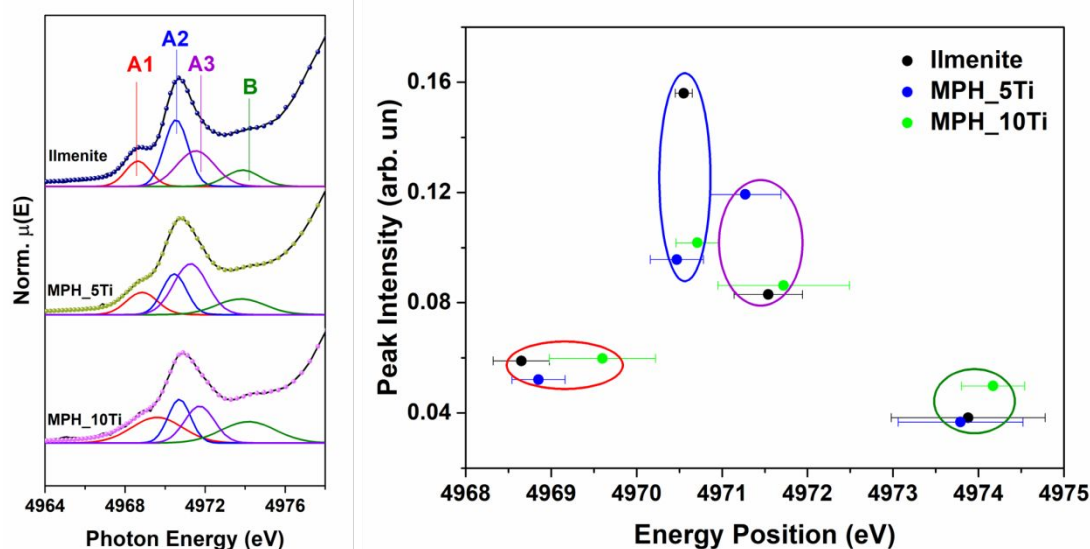
1  
2  
3 The many body amplitude reduction factor was fixed to the value obtained from a fit of a  
4 hematite reference spectrum ( $S_0^2 = 0.90$ ); the fitting parameters were a common value of the  
5 energy origin shift ( $\Delta E_0$ ) and, for each contribution listed below, the interatomic distances (R) and  
6 Debye-Waller factors ( $\sigma^2$ ). R goodness of fit factors were  $\sim 0.01$  for all samples and the fits are  
7 reported as empty circles in Figure 1.  
8  
9  
10  
11

12  
13 We found that the first peak at  $\sim 1.5$  Å and a small shoulder at  $\sim 1.90$  Å are due to the  
14 contribution from single scattering of the six first shell O atoms, the second peak is due to one Fe  
15 atom at 2.86 Å and three Fe atoms at 2.97 Å, the third peak is due to three Fe atoms at 3.38 Å and  
16 six Fe atoms at 3.68 Å. No multiple scattering contributions were included because of their very low  
17 amplitude. The quantitative results of the fit are listed in Table S1. The fitting parameters of Ti-  
18 modified MPH and those of reference hematite exhibit negligible differences, being both compatible  
19 with literature data for hematite;<sup>22,23</sup> this indicates that the presence of Ti(IV) does not alter  
20 significantly the local structure of Fe, which remains very similar to that of hematite.  
21  
22  
23  
24  
25  
26  
27

28 The Ti K-edge XANES of Ti-modified MPH photoanodes and of pseudobrookite ( $\text{Fe}_2\text{TiO}_5$ ),  
29 anatase, brookite, rutile and ilmenite reference samples are shown in Figure 2. The pre-edge  
30 features arise from dipole and quadrupole transitions to bound electronic states in the bottom of  
31 the conduction band originating from Ti 3d/4p and O 2p hybridization<sup>24</sup> and their lineshape is  
32 strongly affected by the oxidation state and local symmetry around Ti.<sup>25,26</sup> The pre-edge features  
33 are highlighted in the left panel of Figure 3. It is known that the A1, A2 and A3 features are due to  
34 transitions to  $t_{2g}$  states and feature B to transitions to  $e_g$  states.<sup>27,28</sup> The rising and main edge region  
35 is attributed to the electronic transition of 1s electrons to continuum states. It can be noted that all  
36 spectral features of Ti-modified MPH are similar to those of ilmenite (with some extra broadening  
37 of the main edge) and are significantly different from those of all Ti oxides and pseudobrookite. This  
38 indicates clearly that Ti is found in a local structure very similar to that of ilmenite.  
39  
40  
41  
42  
43  
44  
45  
46  
47  
48  
49  
50  
51  
52  
53  
54  
55  
56  
57  
58  
59  
60



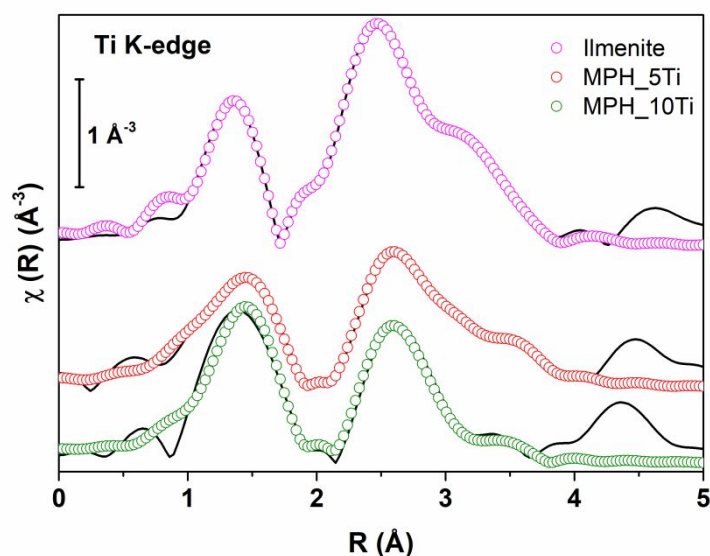
**Figure 2.** Ti K edge normalized XANES spectra of Ti-modified MPH compared to pseudobrookite, anatase, brookite, rutile and ilmenite reference spectra.



**Figure 3.** Left: Ti K pre-edge spectra and fits with four Gaussian features (- Peak A1, - Peak A2 and - Peak A3 and - Peak B), shown for Ti-modified MPH and for reference ilmenite. Right: Corresponding intensity and energy plot. The error bars are standard errors on the peak positions as calculated by the Fityk package. The circles are guides to the eye that group data points pertaining to a given feature.

The pre-edge spectral features of the Ti-modified MPH and ilmenite were fitted by Gaussian components, as shown in the left panel of Figure 3. The numerical results are reported in Table S2. Since it is known that the intensity and the energy position of each peak are related to oxidation state and local coordination, we report these quantities in the right panel of Figure 3 as an intensity versus energy position plot. It is clear that, within the uncertainties, the energies of all components are equal while there are some differences in the intensities and widths. Our conclusion is that the local electronic structure around Ti near the bottom of the conduction band is similar to that in ilmenite. This result points to a similar atomic structure, which was assessed by Ti K edge EXAFS as described below.

The background subtracted Ti K-edge EXAFS spectra are shown in Figure S3. The spectra of Ti-modified MPH have a lineshape similar to the ilmenite spectrum. This indicates that the local coordination around Ti is very similar to the ilmenite local structure, as expected. Ilmenite has trigonal crystal structure with spacegroup 167 (i.e.  $R\bar{3}c:H$ ) as hematite and this structure was used to fit the spectra.



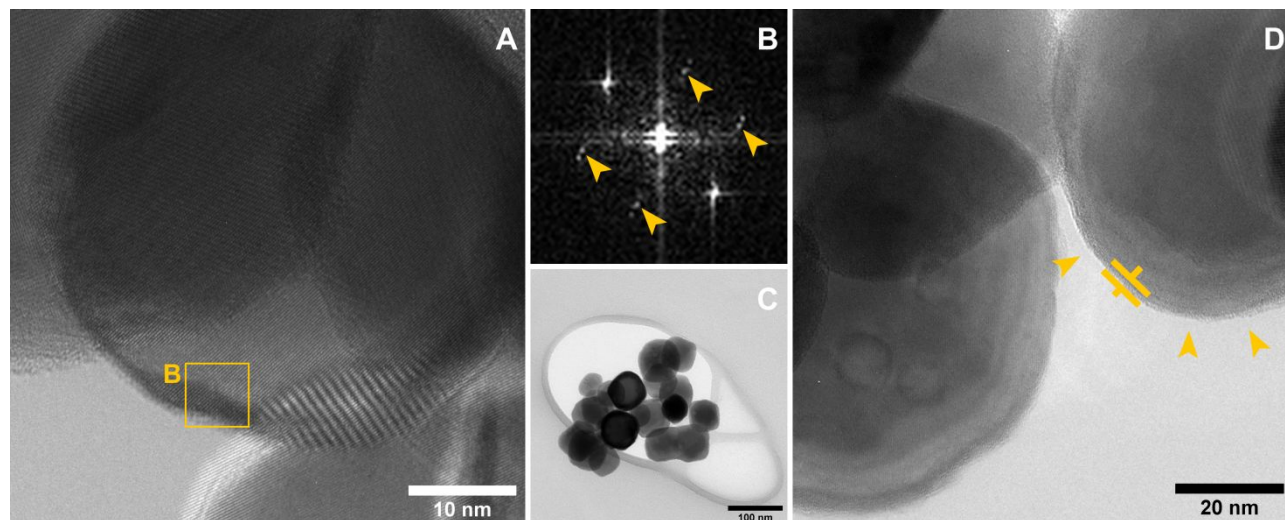
**Figure 4.** Fourier-transformed Ti K edge EXAFS ( $k^2$  weighted) spectra of Ti-modified MPH and reference ilmenite with their best fits (data reported as continuous line and fits as empty circles). Spectra have been vertically offset for clarity.

The Fourier Transforms of Ti K edge EXAFS spectra, obtained in the range  $2.5 \text{ \AA}^{-1} - 9.5 \text{ \AA}^{-1}$  are shown in Figure 4. The only notable differences between the samples and ilmenite are a small shift to higher distances of the first peak and a smaller intensity of the second peak with respect to the first.

1  
2  
3 In the quantitative EXAFS analysis, we sought to distinguish between two options: i)  
4 substitutional Ti atoms within the hematite matrix, or ii) local structure around Ti similar to ilmenite.  
5 The key difference between the two is the contributions giving rise to the second peak in the Fourier  
6 Transforms: in the first case only Ti – Fe contributions would be present while in the second both Ti  
7 – Ti and Ti – Fe are expected. Any attempt to fit the samples' spectra with only Ti – Fe contributions  
8 yielded unphysical structural parameters; we thus conclude that the local structure is in fact similar  
9 to ilmenite. Therefore, all fits were performed on the basis of the known local structure of ilmenite.  
10 The many body amplitude reduction factor was obtained from the best fit of the ilmenite spectrum  
11 ( $S_0^2 = 0.84$ ) and this was fixed in the fits of Ti-modified MPH. The other fitting parameters were a  
12 common energy origin shift ( $\Delta E_0$ ) and interatomic distances (R) and Debye-Waller factors ( $\sigma^2$ ) for  
13 each contribution listed below. The first peak in the ilmenite spectrum was fitted with contributions  
14 originating from three O atoms at  $\sim 1.84$  Å and three more at  $\sim 2.02$  Å; the second peak with three  
15 Ti atoms at  $\sim 2.99$  Å, three Fe atoms at  $\sim 3.41$  Å and 6 O atoms at  $\sim 3.29$  Å; the third by six Fe atoms  
16 at  $\sim 3.76$  Å. No multiple scattering contributions were considered due to their low amplitude. The  
17 photoanodes spectra were fitted in a similar fashion and slight variations in the local structural  
18 parameters were obtained, as summarized in Table S3. Debye Waller factors are nearly always  
19 higher in Ti-modified MPH, indicating a more structurally distorted environment. A significant  
20 difference is that the Ti – O distances in the photoanodes are significantly higher than in ilmenite  
21 and tend to the values of the corresponding Fe – O distances in hematite. This might reflect the  
22 influence of the hematite matrix on the ilmenite – like regions.  
23  
24  
25  
26  
27  
28  
29  
30  
31  
32  
33  
34  
35  
36  
37  
38  
39

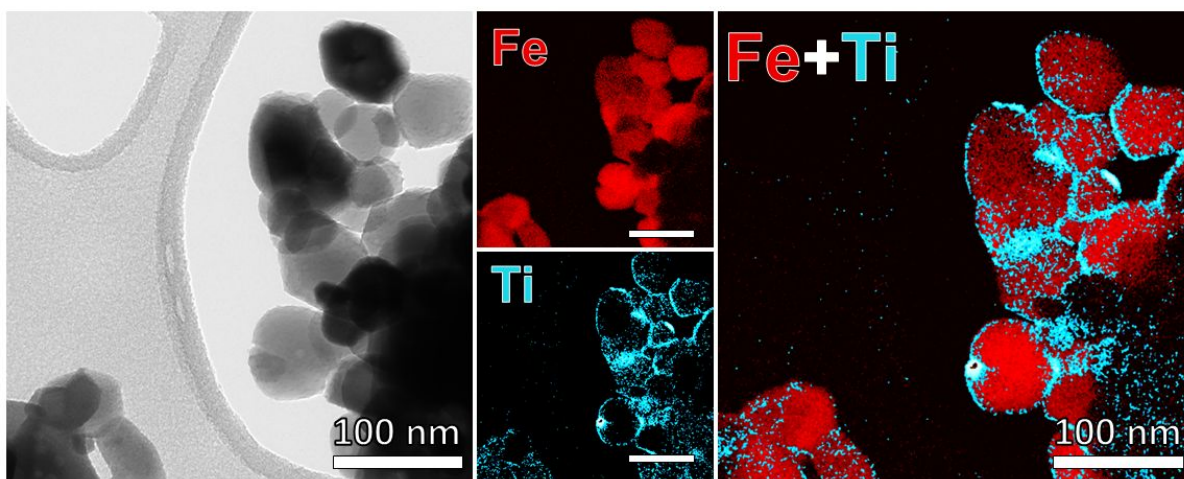
40 This view is reinforced by TEM analyses that additionally provide local information on the  
41 phase distribution at the nanoscale. Structural analyses by selected area electron diffraction (SAED)  
42 and HRTEM confirm hematite as the main phase but also reveal the presence of ilmenite. SAED  
43 analysis (Figure S4) highlights a polycrystalline structure; the diffraction rings characteristic of  
44 hematite are clearly visible. Ilmenite shares the trigonal crystal structure with hematite and, despite  
45 the fact that part of the reflections partially overlap, some planes specific to ilmenite, such as (101)  
46 and (003), are clearly detected in the diffraction micrograph. Moreover, HRTEM structural analysis  
47 in proximity of the surface (Figure 5A-B) reveals again the hematite main phase (Figure 5B, zone axis  
48  $[2 \ -3 \ 2 \ ]$ ) together with reflections indexed to ilmenite (104) planes (marked by arrows figure 5B).  
49 From the morphological point of view, the MPH\_5Ti sample appears to be constituted by well-  
50 shaped crystalline nanoparticles of about 40-70 nm diameter enveloped by a conformal layer with  
51 a thickness in the range 2-4 nm (pointed by arrows in Figure 5C-D). The ESI analysis shown in Figure  
52  
53  
54  
55  
56  
57  
58  
59  
60

6, performed by mapping the Ti and Fe  $L_{2,3}$  energy loss feature, clearly shows Ti enrichment of this layer.

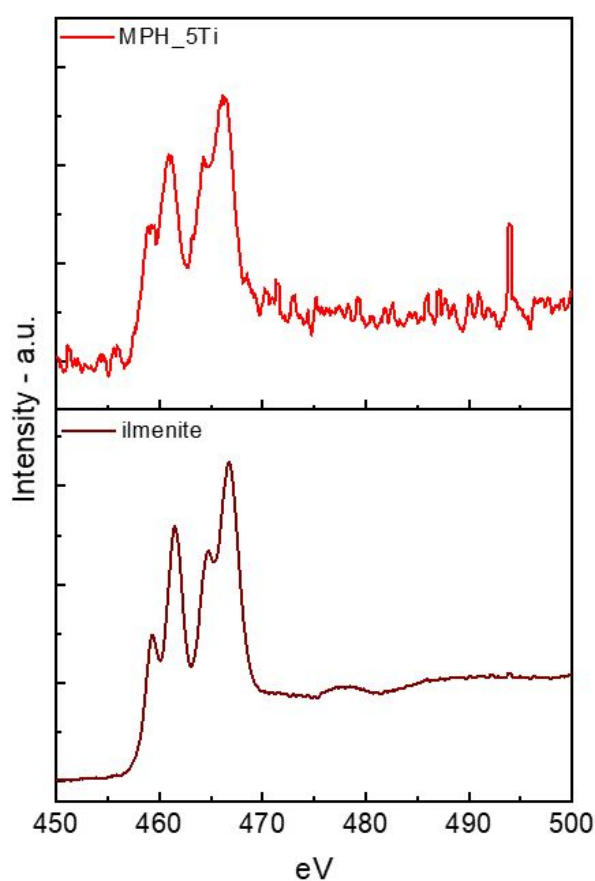


**Figure 5.** A) HRTEM micrographs of MPH\_5Ti and (B) related FFT of the selected region of interest; arrows indicate the reflections indexed as ilmenite (104) planes. C) Low magnification TEM micrograph and (D) HRTEM micrograph that shows the 2-4 nm thin conformal layer around nanoparticles.

The similarity between the Ti  $L_{2,3}$  edge EELS spectra for sample MPH\_5Ti and for an ilmenite reference sample (Figure 7) clearly indicates that the Ti-rich outer layers around the nanoparticles are ilmenite, in agreement with the outcome of EXAFS analysis. In fact, the energies of the edge onsets for both the  $L_2$  edge at 464.3 eV and the  $L_3$  edge at 458.9 match well the reference ones at 464.7 eV and 459.3 eV, respectively; moreover, the overall lineshape (including the crystal field splitting of each edge and the corresponding branching ratios) of the MPH\_5Ti spectrum correspond quite well with that of the ilmenite reference. Moreover, the EELS spectrum of sample MPH\_5Ti differs significantly from those of rutile, anatase, and amorphous  $TiO_2$  (Figure S5).



**Figure 6.** TEM micrographs of MPH\_5Ti, related ESI Fe and Ti maps and the combined map.



**Figure 7.** EELS spectra for MPH\_5Ti specimen (above) and reference ilmenite (below) recorded under the same experimental conditions at the Ti  $L_{2,3}$  edge.

Although ilmenite is reported to have a valence band edge which is not properly aligned to accept holes from the valence band (VB) of hematite,<sup>29</sup> in our case the very thin (2-4 nm) FeTiO<sub>3</sub> layer does not hinder the hole transfer to the electrolyte, as clearly demonstrated by the significant

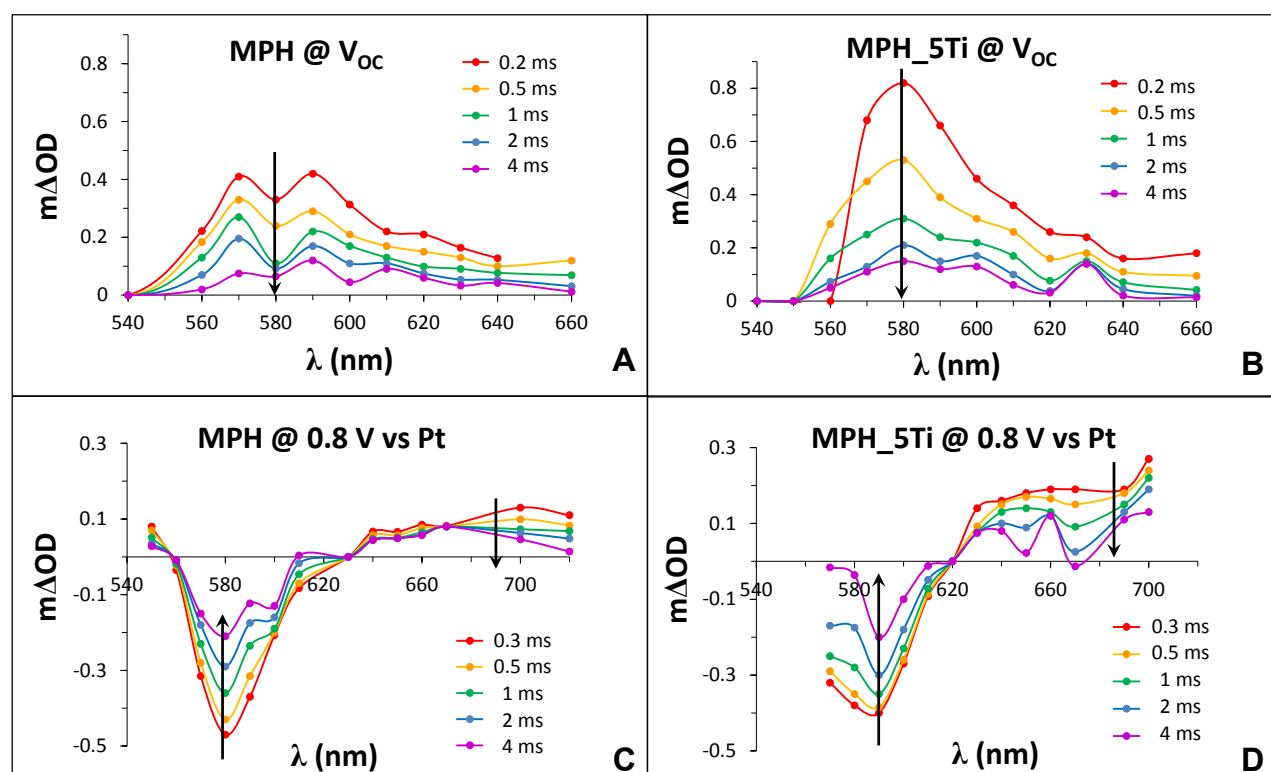
1  
2  
3 improvement of the PEC performance of the MPH\_5Ti electrodes compared to the MPH counterpart  
4 (Figure S1). A favorable band alignment is instead obtained in other kind of composites, such as  
5 those constituted by hematite and pseudobrookite  $\text{Fe}_2\text{TiO}_5$ .<sup>7, 30, 31</sup> In this case, the  $\text{Fe}_2\text{TiO}_5$  phase  
6 allows for the formation of a type II heterojunction with  $\alpha\text{-Fe}_2\text{O}_3$ , leading to maximum photocurrent  
7 values up to 3 mA/cm<sup>2</sup> when a nickel/iron oxide OEC is introduced.<sup>31</sup>  
8  
9

10  
11  
12 Furthermore, to the best of our knowledge, our report is the first in which a thoroughly  
13 characterized  $\text{Fe}_2\text{O}_3/\text{FeTiO}_3$  composite is used in a photoanodic set-up for water oxidation. Indeed,  
14 this combination is generally used for its magnetic properties,<sup>32,33</sup> while photoelectrochemical or  
15 photocatalytic applications often exploit  $\text{FeTiO}_3/\text{TiO}_2$  junctions.<sup>34,35,36</sup>  
16  
17  
18  
19  
20

### 21 ***TAS and TPC measurements on the photoanodes***

22  
23 In order to evaluate the effect of the ilmenite phase on the interfacial dynamics of the  
24 photogenerated charges, we have performed TAS and TPC measurements on unmodified MPH and  
25 on MPH\_5Ti, i.e. the best performing photoanode in terms of Ti(IV) content. The latter was also  
26 functionalized with FeOEC with the aim to investigate its role in photoelectrochemical water  
27 oxidation.  
28  
29  
30  
31

32 The TA spectra for MPH and MPH\_5Ti photoanodes at  $V_{oc}$  are reported in Figure 8A-B. The  
33 laser excitation power was kept as low as possible in order to observe dynamics that could be related  
34 to the behavior of the photoanode under solar illumination, resulting in a small optical density  
35 difference ( $\Delta OD$ ) in the order of  $10^{-4}$ . TA spectra at  $V_{oc}$  are dominated by a broad absorption band  
36 at wavelengths between 540 and 640 nm peaking around 580-590 nm, which decays in the ms time  
37 scale. This feature, common to both MPH and MPH\_5Ti, can be attributed to photohole trapping in  
38 intragap states located a few 100s meV below the conduction band, as demonstrated by the Durrant  
39 group for other nanostructured hematite photoanodes.<sup>37</sup> In the absence of an applied bias, these  
40 intragap states (below the Fermi level) are occupied by electrons and therefore do not contribute  
41 to ground state absorption. After laser pulse excitation, valence band photoholes are rapidly ( $\ll$   
42 ms) trapped at these states, making them available for optical transitions of valence band electrons  
43 that lead to the observed transient absorption band. Its decay is due to the filling of the intragap  
44 states by photoexcited electrons in the conduction band. In other words, the intragap states act as  
45 recombination centers. The fact that the absorption band is more intense (almost double) in the  
46 case of MPH\_5Ti points to a higher number of available states for the holes to be trapped in, due to  
47 the formation of the hematite-ilmenite heterointerface.  
48  
49  
50  
51  
52  
53  
54  
55  
56  
57  
58  
59  
60



**Figure 8.** Transient absorption spectra of MPH and MPH\_5Ti photoanodes at both  $V_{OC}$  (A-B) and  $0.8\text{ V vs Pt}$  applied bias (C-D).

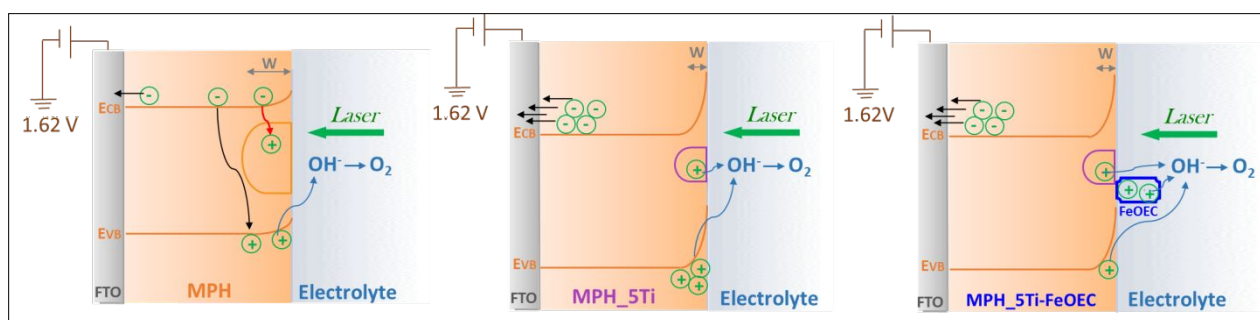
When the photoanodes are biased at  $0.8\text{ V vs Pt}$  (the potential at which the limiting photocurrent is observed in a 2-electrode configuration, see Figure S1B for the corresponding J-V curves), the spectral characteristics change. An intense bleach appears at a similar wavelength of  $V_{OC}$  transient absorption (centered at 580 and 590 nm for MPH and MPH\_5Ti respectively, see Figure 8C-D). Moreover, a broad absorption band at  $\lambda > 630\text{ nm}$  extending into the red is visible. This spectral behavior is consistent with previous observations.<sup>37</sup>

The origin of the bleaching can be understood considering again the intragap states, as follows. Under applied anodic bias, optical absorption at 580-590 nm takes place in the ground state because the intragap states are empty, at least within the space charge region. However, after laser excitation, the intragap states are rapidly ( $\ll\text{ms}$ ) filled by photoexcited electrons in the conduction band. This reduces absorption at 580-590 nm, generating a negative  $\Delta OD$  signal, approximately 90% of which is recovered within 10 ms (Figure S6A). Moreover, as reported in Figure S6B, for both MPH and MPH\_5Ti electrodes, the bleach intensity increases (in absolute value) with the square-root of the applied bias, further confirming that this dynamics originates from the extension of the space charge layer in the photoanode upon positive polarization.



On the other hand, the broad feature at  $\lambda > 630$  nm has been attributed to photoholes swept by the electric field at the semiconductor/electrolyte interface (SEI).<sup>37</sup> It is interesting to note that it is at least two times higher in the Ti-modified electrode, consistent with the improved photoelectrochemical performance.

In order to investigate the role of the different components of the photoanodic interfaces in more detail, we have performed TPC measurements. The photocurrent decay was recorded when striking the photoanode from the “front” (i.e. the electrolyte side, as opposed to the FTO collector “back” side) under variable bias (Figure S7). These experiments are schematized in Figure 9, considering the different behavior of the three interfaces under 1.62 V (vs RHE) applied bias and highlighting the possible pathways for the fate of the charge carriers generated by the laser pulse.



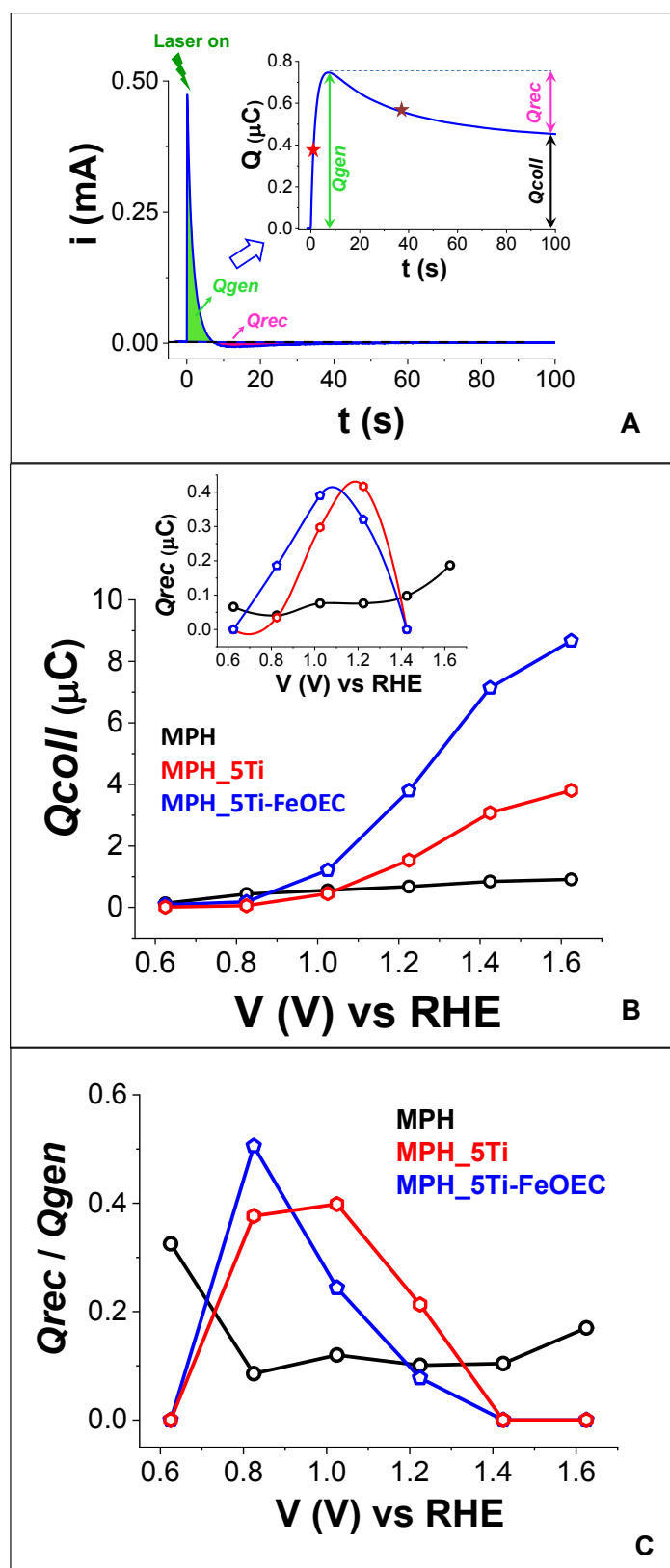
**Figure 9.** Pictorial representation of the processes occurring at the SEI interfaces of the three different photoanodes under 1.62 V applied bias. The black arrows indicate the processes related to the fast recombination channels competing with electron collection at the back contact, while the red ones indicate slow recombination pathways involving the holes trapped in intragap states. Blue arrows indicate the hole transfers responsible for the interfacial oxygen evolution reaction.

Figure 10A reports a typical transient chronoamperometric trace in the 1-100 ms time domain, showing the following distinctive features: (i) a positive photocurrent peak, which is originated by collection of laser-generated electrons at the back contact and usually decays on a 10 ms time scale, in agreement with the transient lifetime observed by TAS. The corresponding photocharge peak rise; in the following we call  $\tau_1$  the time at half-amplitude; (ii) a negative transient (with half-amplitude time as  $\tau_2$ ), corresponding to a photocharge that extends up to 100 ms, originated by the recombination of the photogenerated electrons with holes trapped in surface states, and thus not injected into the electrolyte. The integral of these transient features yields the temporal evolution of the photogenerated charge (inset of Figure 10A), thus allowing for the

1  
2  
3 identification and quantification of the different processes framed by the two different time regimes  
4 (10 ms and 100 ms). In particular, we define: (i)  $Q_{gen}$ , as the area subtended by the positive  
5 photocurrent peak, which is the result of the kinetic competition between electron transport at the  
6 collector and fast recombination processes involving reaction with mobile holes (VB holes) or holes  
7 contained in shallow traps; (ii)  $Q_{rec}$ , as the charge lost due to slower recombination processes  
8 involving long lived surface-trapped holes; and (iii)  $Q_{coll}$ , as the actual collected charge, given by the  
9 difference between the other two contributions, according to:

$$Q_{coll} = Q_{gen} - |Q_{rec}| \quad (2)$$

10  
11 We calculate these charges for all the TPC traces are reported in Figure S7. Figure 10B shows  
12 the resulting bias dependence of  $Q_{coll}$  and  $Q_{rec}$  (inset) for all the investigated photoanodes, while  
13 the curves corresponding to  $Q_{gen}$  are reported in Figure S8A. In general, the magnitude of the  
14 photocurrent transients increases in the order MPH < MPH\_5Ti < MPH\_5Ti-FeOEC (Figure S7) and  
15 the resulting trend in  $Q_{coll}$  is consistent with the J-V curves obtained under 1 sun illumination (see  
16 Figure S1A), confirming that the presence of the ilmenite overlayer improves the collection of  
17 photogenerated charge. We note that the  $Q_{coll}$  vs V trend reported in Figure 10B is exacerbated  
18 compared with the conventional J-V curves (Figure S1), due to the front side illumination geometry  
19 herein adopted, which is the most unfavorable for the collection of charge carriers in hematite.  
20  
21  
22  
23  
24  
25  
26  
27  
28  
29  
30  
31  
32  
33  
34  
35  
36  
37  
38  
39  
40  
41  
42  
43  
44  
45  
46  
47  
48  
49  
50  
51  
52  
53  
54  
55  
56  
57  
58  
59  
60



**Figure 10.** (A) Typical TPC decay and corresponding photogenerated charge trace (inset) obtained after its integration over time, illustrating the contributions due to  $Q_{\text{gen}}$ ,  $Q_{\text{rec}}$  and  $Q_{\text{coll}}$ . The values indicated with the red and purple stars correspond to the times at half amplitude  $\tau_1$  and  $\tau_2$

1  
2  
3 (*vide infra*). In this specific case, the *i-t* trace corresponds to a MPH\_5Ti photoanode held at 1.02  
4 V bias. (B,C) Applied bias dependence of  $Q_{coll}$  (B) and  $Q_{rec}$  (B, inset) and of  $Q_{rec}/Q_{gen}$  (C) for  
5 MPH, MPH\_5Ti, and MPH\_5Ti-FeOEC.  
6  
7  
8  
9  
10

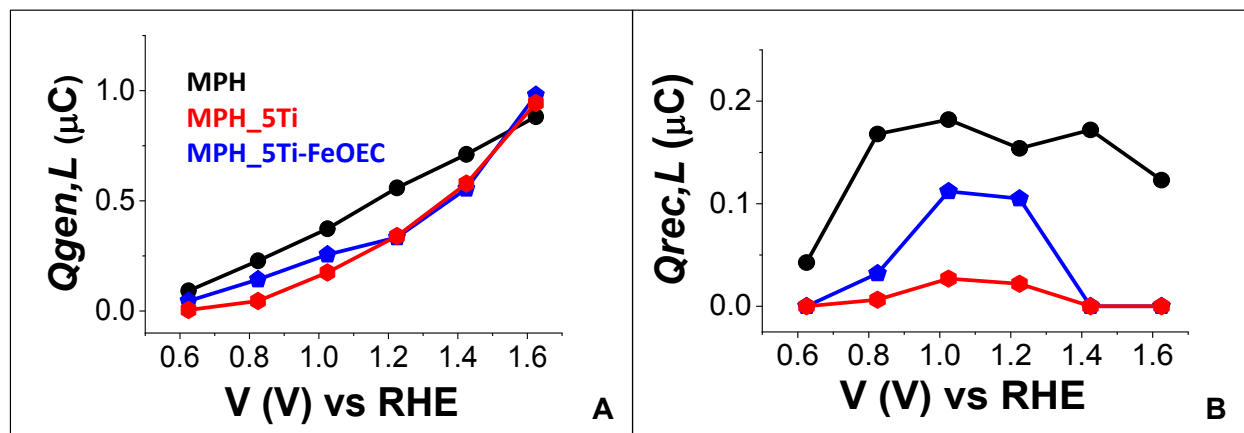
11 Furthermore, the time at which the  $Q_{gen}$  reaches half of its peak value ( $\tau_1$ , see also inset of  
12 Figure 10A) is essentially constant within the explored potential range, being *ca.* 0.5 ms for MPH,  
13 *ca.* 1.5 ms for MPH\_5Ti and *ca.* 4 ms for MPH\_5Ti-FeOEC (see Figure S8B). This suggests that fast  
14 recombination processes are partially inhibited by the presence of the ilmenite layer, allowing to  
15 extend the useful timeframe for the collection of photogenerated electrons.  
16  
17  
18  
19  
20

21 The applied bias dependence of  $Q_{rec}$  (inset of Figure 10B) gives further insight on the  
22 differences in the photoanodic performance. Indeed, we obtain a distribution of low (*ca.* 0.05  $\mu\text{C}$ )  
23 and almost constant values for MPH, meaning that the fraction of holes that are able to survive fast  
24 recombination and undergo slow recombination with electrons is smaller in such electrodes. On the  
25 contrary, a well-defined bell-shaped behavior is observed for both MPH\_5Ti and MPH\_5Ti-FeOEC  
26 within the interval  $0.6 \leq V \leq 1.4$  V, indicating that a more significant fraction of holes is now trapped  
27 in long-lived surface states, as a result of the interfacial modification. The distribution of  $Q_{rec}$  peaks  
28 between 1.0 and 1.2 V, in agreement with the surface chemical capacitance distribution found by  
29 EIS experiments in these (*vide infra*) and other types of bare and Ti-modified hematite  
30 electrodes.<sup>7,13,17,38,39</sup> We note that the  $Q_{rec}/Q_{gen}$  ratio, shown in the inset of Figure 10C, is higher  
31 in the Ti-modified electrodes, and that, contrary to MPH, it drops to 0 for an applied potential  $\geq 1.4$   
32 V. This behavior can be explained by the buildup of a stronger electric field inside the Ti-modified  
33 electrodes compared to unmodified ones as the positive potential increases. The enhanced field  
34 sweeps electrons away from the surface to the collector, leaving holes free to react with water. We  
35 can argue that the space charge inside unmodified hematite does not develop enough to guarantee  
36 efficient collection, while the structural changes induced by Ti incorporation at the interface allow  
37 to sustain a stronger electric field and bring about a redistribution of surface states. These effects,  
38 pointed out by the Andreu group for  $\text{Fe}_2\text{O}_3/\text{Fe}_2\text{TiO}_5$  heterojunctions,<sup>7</sup> may be also related to Fermi  
39 Level unpinning, that was observed in the presence of a thin buffer layer of hematite underneath  
40 the MPH and greatly improved electron collection.<sup>17</sup> It is worth noting that in the case of MPH\_5Ti-  
41 FeOEC, hole trapping in the catalyst's states causes the formation of high-valence iron species,<sup>40</sup>  
42 which are in turn able to oxidize water and evolve oxygen.  
43  
44  
45  
46  
47  
48  
49  
50  
51  
52  
53  
54  
55  
56  
57  
58  
59  
60

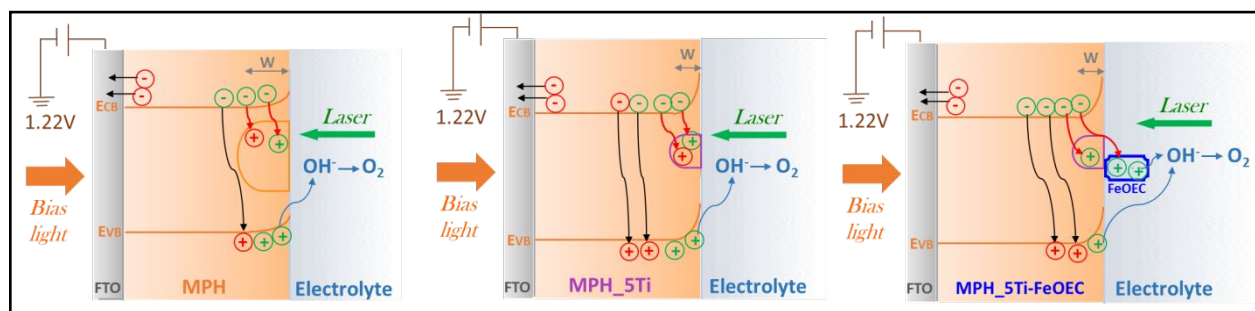
1  
2  
3 Cyclic voltammetry (CV) in the dark can be useful to investigate the role and the nature of  
4 the donor states in Ti-modified hematite and to verify the hypothesis that the ilmenite overlayer  
5 passivates surface states. The CV curves reported in Figure S9A were recorded after pre-  
6 conditioning at 1.6 V, in order to extract charge from donor states close to the conduction band  
7 edge. The potential was then scanned from 1.6 V to the cathodic direction, until the threshold of  
8 the conduction band edge of the semiconductor was reached, and then backwards to the initial  
9 potential. We observe in both MPH and MPH\_5Ti a well-defined wave, which is more reversible and  
10 intense (about a factor 4.5) in the latter sample, centered around 0 V and originating from the filling  
11 of donor states ( $N_D$ ) close to the semiconductor band edge.<sup>41</sup> A similar response was recorded for  
12 MPH\_5Ti-FeOEC. The increased  $N_D$  value is consistent with a Mott-Schottky (MS) analysis carried  
13 out on similar Ti(IV)-modified electrodes, where a 3-fold increase in  $N_D$  was observed.<sup>13</sup> Herein,  
14 however, we have preferred to explore the CV response, rather than perform high-frequency  
15 electrochemical impedance spectroscopy, due both to difficulties in knowing the dielectric constant  
16 of the modified interface and to the issue of frequency dispersion,<sup>42</sup> which makes the evaluation of  
17 the donor density by MS analysis quite uncertain. Prior to the main cathodic wave, unmodified MPH  
18 also shows a broad pre-wave at ca. 0.7 V. This feature, well evident when the voltammetric curves  
19 are compared at the same current density (Figure S9B), is absent in the Ti-modified samples. The  
20 pre-wave can be ascribed to the presence of deep electron traps at about 400 meV below the CB  
21 edge,<sup>43</sup> which may pin the Fermi Level of MPH and cause recombination. Its absence in Ti-modified  
22 MPH indicates that the ilmenite overlayer acts as a deep trap passivating agent, while also inducing  
23 a greater number of oxygen vacancies, which were reported to improve the photocurrent response  
24 of hematite through the reduction of bulk recombination. This performance was attributed both to  
25 an increase in film conductivity and to a stronger depletion field, supported by the higher donor  
26 density.<sup>44,45</sup>

27  
28  
29  
30  
31  
32  
33  
34  
35  
36  
37  
38  
39  
40  
41  
42  
43  
44  
45  
46  
47  
48 With the aim to unravel space charge effects, we also carried out TPC experiments under  
49 additional white light illumination provided by a solar simulator set to 0.4 W/cm<sup>2</sup> irradiance (see  
50 Figure S10 for a typical J-V curve obtained under these conditions). This condition creates a large  
51 steady state population of charge carriers, which is slightly perturbed by the laser pulse. Under such  
52 conditions, the generated and recombined charges are termed  $Q_{gen,L}$  and  $Q_{rec,L}$ ; their dependence  
53 on the applied bias are reported in Figure 11. In Figure 12, we report a schematic representation of  
54 the charge transfer dynamics when both the laser and the white light sources shine from opposite  
55 directions under 1.22 V applied potential. This intermediate bias was chosen as a representative  
56  
57  
58  
59  
60

voltage, at which the various dynamics occurring at different timescales can be simultaneously observed.



**Figure 11.** Applied bias dependence of  $Q_{gen,L}$  (A) and  $Q_{rec,L}$  (B) in the presence of a strong white light stimulus provided by a solar simulator shining from the back contact.



**Figure 12.** Pictorial representation of the three different interfaces in the presence of an additional white light illumination and under 1.22 V applied bias. Laser-generated carriers are indicated in green, while the steady-state population of electrons and holes in red. The black arrows indicate the processes related to  $Q_{gen,L}$ , while the red ones indicate recombination pathways involving intragap states ( $Q_{rec,L}$ ). The blue arrows indicate the hole transfers responsible for the interfacial reaction of oxygen evolution.

Strikingly, under white light illumination the magnitude of the photocurrent transients in the best performing Ti-modified MPH electrodes is strongly reduced, resulting in  $Q_{gen,L}$  values that are *ca.* 5 and 10 times lower than  $Q_{gen}$  for MPH\_5Ti and MPH\_5Ti-FeOEC respectively. By contrast,  $Q_{gen,L}$  remains substantially unvaried with respect to the dark counterpart in the case of MPH. Figure 11A shows that  $Q_{gen,L}$  values are higher (up to 1.4 V) in unmodified MPH compared to Ti-modified MPH, in spite of its poorer photoanodic performance. At the same time,  $Q_{gen,L}$  maintains

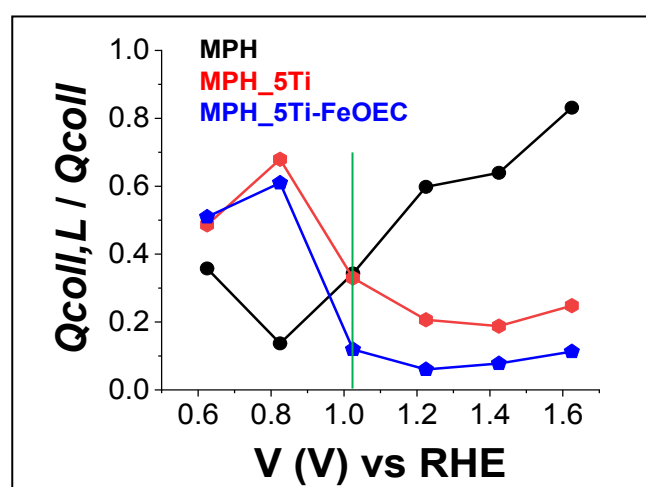
1  
2  
3 the expected increase when the bias becomes more anodic. This counterintuitive behavior can be  
4 rationalized in terms of charge recombination at the surface of the electrodes between electrons  
5 produced by the laser pulse and holes generated by white light. It should be recalled that the laser  
6 pulse strikes from the electrolyte side and that the penetration depth of 355 nm radiation in MPH  
7 films is estimated in the 25-50 nm range (see [note 1]), in good agreement with the known extinction  
8 coefficient of hematite.<sup>46</sup> The constant white light illumination generates electrons and holes, which  
9 are swept in opposite directions by the electric field created inside the photoanode. Electrons travel  
10 to the collector, while holes accumulate at the SEI. The stronger the electric field at a given potential,  
11 the higher the hole density at the interface with the electrolyte. Thus, in the electrodes displaying a  
12 stronger depletion layer, i.e. MPH\_5Ti and MPH\_5Ti-FeOEC, the laser pulse generates electrons in  
13 a spatial region densely populated by holes, causing fast recombination and decreasing the intensity  
14 of  $Q_{gen}$  and  $Q_{coll}$  transients. In agreement with this interpretation, the time at half amplitude  
15 measured for  $Q_{gen,L}$  (named  $\tau_{1,L}$  and reported in Figure S11) is *ca.* half of the dark  $\tau_1$  value for  
16 MPH\_5Ti, and up to 4 times lower than  $\tau_1$  for MPH\_5Ti-FeOEC (compare Figure S8B and S11). On  
17 the contrary,  $\tau_{1,L}$  and  $\tau_1$  are very similar in the case of the MPH photoanodes. The stronger decrease  
18 in the  $\tau_{1,L}$  values in the presence of the catalyst can be well explained by the occupation of the  
19 surface FeOEC sites by the photogenerated holes at  $V \geq 1.0$  V.

20  
21  
22  
23  
24  
25  
26  
27  
28  
29  
30  
31  
32  
33  
34  
35  
36  
37  
38  
39  
40  
41  
42  
43  
44  
45  
46  
47  
48  
49  
50  
51  
52  
53  
54  
55  
56  
57  
58  
59  
60  
Due to fast recombination within the penetration depth of 355 nm laser pulses,  $Q_{rec,L}$  also  
decreases by at least a factor of 5 with respect to  $Q_{rec}$  for both MPH\_5Ti and MPH\_5Ti-FeOEC  
(compare Figure 11B and 10B). In any case,  $Q_{rec,L}$  maintains the bell-shaped distribution observed  
in the absence of the white light bias and still drops to 0 for  $V \geq 1.4$  V. After this threshold, a relative  
increase in both  $Q_{gen,L}$  and, as a consequence, in  $Q_{coll,L}$  can be also observed (Figure S12).  
Furthermore, the MPH\_5Ti-FeOEC photoanode displays higher  $Q_{rec,L}$  values with respect to those  
of MPH\_5Ti. This finding suggests that, in the presence of the amorphous and electrolyte permeable  
catalyst, an increased number of electronic states are available on the FeOEC for the localization of  
photogenerated holes.<sup>16,38</sup>

The transient photocharge dynamics of MPH in the presence of white light illumination are  
consistent with the presence of a thinner space charge layer, which can be ascribed to Fermi level  
pinning by deep traps, as previously discussed. Indeed, for MPH the  $Q_{rec,L}$  values are almost  
constant for  $V \geq 0.8$  V, and approximately doubled with respect to dark  $Q_{rec}$  values. A plausible  
interpretation is that holes generated under white light and trapped in the MPH surface states do

not experience a significant surface accumulation upon application of anodic bias. The larger number of photo-produced holes, with respect to the dark case, enhances their probability of slow recombination with the laser-produced electrons, explaining the increase in  $Q_{rec,L}$ .

The overall behavior of the analyzed photoanodes is summarized in Figure 13, in which we report the bias dependence of the ratio between the transiently collected charge in the presence ( $Q_{coll,L}$ ) and in the absence ( $Q_{coll}$ ) of the white light source. Once again, the observed trends clearly illustrate the differences between MPH and the ilmenite-modified MPH photoelectrodes in terms of charge separation. When the  $FeTiO_3$  phase at the interface with the electrolyte is present, the  $Q_{coll,L}/Q_{coll}$  drops as soon as the voltage reaches 1.0 V due to accumulation of photoholes at the SEI where laser-induced electron generation occurs. These surface hole localization effects are strongest in the best-performing electrode (MPH\_5Ti-FeOEC), in which the steepest decrease to the lowest  $Q_{coll,L}/Q_{coll}$  is related to the highest photocurrent and clearly tied to photocurrent generation, as it can be appreciated from the onset of the J-V characteristics between 0.92 and 1.02 V (Figure S1A). Thus, although the band edges of ilmenite are not properly aligned with those of hematite to promote a downhill electron transfer cascade capable to enhance charge separation, it contributes to heterointerfacial effects, which equally result in the suppression of carrier recombination. Hence, by combining the information gained from both TPC and CV experiments, we can conclude that formation of the  $FeTiO_3$  overlayer passivates deep traps that otherwise cause recombination, and induce a greater concentration of donor levels close to the conduction band edge, which allow building up a stronger depletion layer.



**Figure 13.** Applied bias dependence of  $Q_{coll,L}/Q_{coll}$ .



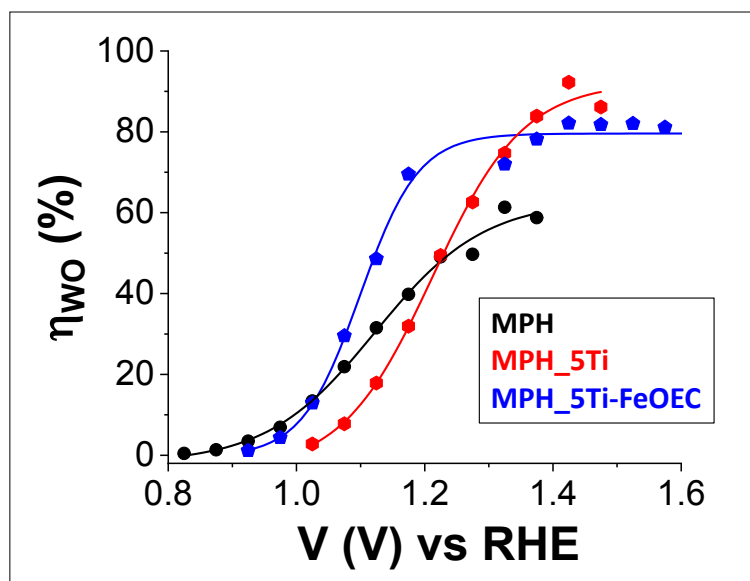
1  
2  
3 The insights gained by TPC measurements were corroborated by means of electrochemical  
4 impedance spectroscopy (EIS) under illumination. The resulting Nyquist plots are reported in Figure  
5 S13A-C, and fitted using the equivalent circuit model indicated in Figure S13D. The elements of this  
6 particular circuit, often used to model hematite-based photoanodes,<sup>47,38,48</sup> include the space charge  
7 capacitance of hematite ( $C_{SC}$ ), the charge transport resistance through the space charge ( $R_{SC}$ ), the  
8 surface state capacitance ( $C_{SS}$ ) and the resistance of the charge transfer from the surface states to  
9 the electrolyte ( $R_{CT,SS}$ ). While  $C_{SC}$  and  $R_{SC}$  are related to high-frequency (*i.e.* faster) processes,  $R_{CT,SS}$   
10 and  $C_{SS}$  are associated to the low frequency (slower) processes taking place at the interface with the  
11 electrolyte. This results in Nyquist plots composed by two different arcs, which in our specific case  
12 collapse into a single one at high applied bias ( $V \geq 1.4$  V).

13  
14 The adequacy of the circuit model is confirmed by the good correlation observed when the  
15 plots of the differential resistances ( $dI/dV$ , calculated from the I-V curves) versus the applied  
16 potential are compared to the corresponding  $R_{TOT}^{-1}$  values (Figure S14). In particular, the total  
17 resistance ( $R_{TOT}$ ) is calculated by adding  $R_{SC}$ ,  $R_{CT,SS}$  and the serial resistance ( $R_s$ ).

18  
19 The EIS data also confirmed the expected bell-shaped distribution of  $C_{SS}$  for the Ti-modified  
20 electrodes (Figure S15A), exhibiting at least one order of magnitude higher values with respect to  
21 those of MPH. This observation is consistent with the better charge separation observed for  
22 MPH\_5Ti and MPH\_5Ti-FeOEC electrodes, yielding a higher surface concentration of high-valence  
23 iron-oxo species promoting water oxidation.<sup>39</sup> As a result, the corresponding  $R_{CT,SS}$  values are  
24 considerably lower with respect to those of MPH (Figure S15B). A further contribution to the higher  
25  $C_{SS}$  values can be ascribed to the presence of a larger surface concentration of Fe(III)-OH upon Ti-  
26 incorporation, as reported by the Hamann group for atomic layer deposited hematite electrodes.<sup>49</sup>

27  
28 Moreover, when MPH\_5Ti is functionalized with FeOEC, the  $C_{SS}$  values further increase (up  
29 to a factor 4 with respect to MPH\_5Ti) and the differential capacitance peak is slightly shifted in  
30 cathodic direction. This confirms the picture of hole trapping into catalyst sites during MPH\_5Ti-  
31 FeOEC operation. At the same time, it is worth noting that the maximum  $C_{SS}$  nicely correlates with  
32 both the inflection point of the J-V curve and the minimum value of  $R_{CT,SS}$  (observed at 1.22 V for  
33 MPH\_5Ti-FeOEC, see Figure S16).

34  
35 Finally, we used the EIS data to calculate the efficiency for the water oxidation process ( $\eta_{WO}$ ),  
36 as reported by the groups of Peter<sup>50</sup> and Mendes,<sup>51</sup> and briefly illustrated in the SI.



**Figure 14.** Applied bias dependence of the efficiency of water oxidation ( $\eta_{WO}$ ) for MPH (black), MPH\_5Ti (red) and MPH\_5Ti-FeOEC (blue) photoanodes recorded in 0.1 M KOH (pH 13.3) under 1 sun ( $0.1 \text{ W/cm}^2$ , AM1.5G) illumination.

Figure 14 reports the  $\eta_{WO}$  values obtained for the different photoanodes, which, as expected, mirror the trend of the J-V curves (see also Figure S1A). Indeed, the  $\eta_{WO}$  accounts for the fact that only the photogenerated charges able to survive recombination can reach the interface and perform water oxidation. The best results were obtained for MPH\_5Ti-FeOEC electrodes that are able to operate with 80% efficiency already at applied potentials close to the thermodynamic value for water oxidation. These results are in line with those obtained for other hematite-based interfaces functionalized with different metal oxides catalysts, e.g. iridium/ruthenium based OECs,<sup>51</sup> and nickel/iron based OECs.<sup>48</sup>

## Conclusions

State-of-the-art XANES and EXAFS measurements have been used to gain advanced structural/chemical knowledge about the origin of the enhanced PEC performance in Ti(IV)-modified mesoporous hematite photoanodes. In particular, we demonstrate that the inclusion of Ti(IV) does not influence the local structure of Fe, which remains that of hematite, and that the local electronic and atomic structure around Ti are similar to those of ilmenite ( $\text{FeTiO}_3$ ).

1  
2  
3 As illustrated by TAS, TPC and EIS analyses, the formation of this mixed phase results in a  
4 main beneficial mechanistic pathway for the modified interfaces, related to the passivation of deep  
5 electron traps, which act as recombination centers and cause Fermi level pinning in unmodified  
6 hematite. At the same time, it induces a higher concentration of oxygen vacancies acting as donor  
7 states close to the conduction band edge. Therefore, better charge separation is possible thanks to  
8 the build-up of a stronger electric field inside the semiconductor, which directs holes at the interface  
9 with the electrolyte.  
10  
11  
12  
13  
14  
15

16 Despite the misalignment between hematite and ilmenite band edges, the thin and  
17 discontinuous nature of the FeTiO<sub>3</sub> layer allows for a sufficient coupling between the surface  
18 trapped holes and water for the charge transfer to occur.  
19  
20  
21

22 We also confirmed that the functionalization of the Fe<sub>2</sub>O<sub>3</sub>/FeTiO<sub>3</sub> interface with an  
23 electrolyte-permeable and amorphous catalyst (FeOEC) yields a ternary composite electrode with  
24 enhanced hole injection capabilities towards the electrolyte, resulting in photocurrents up to 1.45  
25 mA/cm<sup>2</sup> at 1.7 V vs RHE.  
26  
27  
28  
29

30 The present understanding of charge transfer dynamics in low-cost and highly stable  
31 materials, made of earth abundant and non-toxic elements, will guide the development of tailored  
32 composite photoanodes for solar water splitting with enhanced photoelectrochemical outputs.  
33  
34  
35  
36  
37  
38

39  
40 [Note 1]. The optical penetration depth ( $\alpha$ ) of 355 nm photons in our hematite samples was directly  
41 calculated from the film thickness ( $l$ ) and absorbance ( $A$ ), using the formula:  
42  
43

$$44 \alpha \text{ (cm}^{-1}\text{)} = \ln(10) \times A / l \text{ (cm).}$$

45  
46

### 47 **Supporting Information**

48  
49 Photoanodes preparation, Experimental details for transient measurements and EIS, J-V curves,  
50 EXAFS spectra and tables of results, Selected area electron diffraction, EELS spectra, Transient  
51 absorption spectroscopy, Transient photocurrent traces and data analyses, Cyclic voltammetry,  
52 Electrochemical impedance spectroscopy (Nyquist plots and circuit-based analyses).  
53  
54  
55  
56  
57  
58  
59  
60

## REFERENCES:

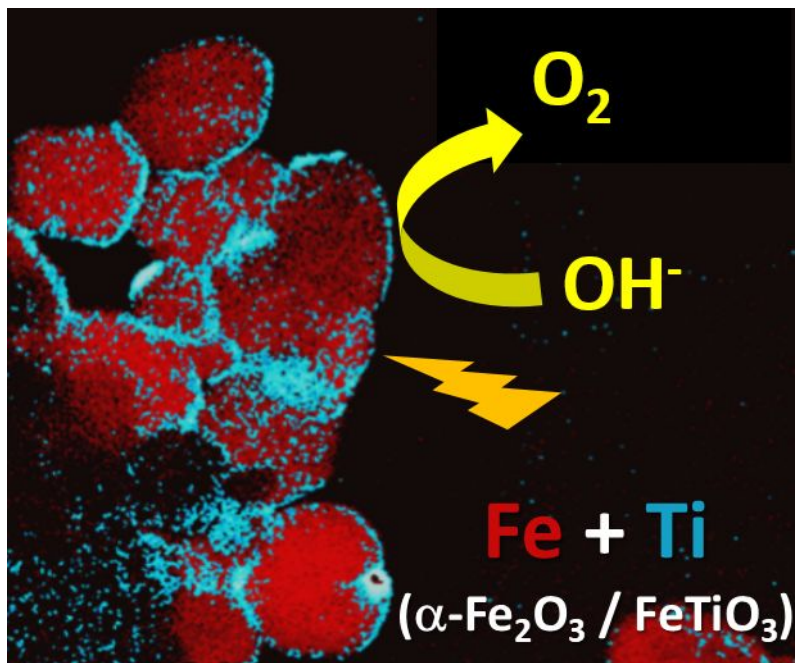
1. Lewis, N. S., Research opportunities to advance solar energy utilization. *Science* **2016**, *351*, aad1920.
2. Montoya, J. H.; Seitz, L. C.; Chakhranont, P.; Vojvodic, A.; Jaramillo, T. F.; Nørskov, J. K., Materials for solar fuels and chemicals. *Nat. Mater.* **2017**, *16* (1), 70-81.
3. Walter, M. G.; Warren, E. L.; McKone, J. R.; Boettcher, S. W.; Mi, Q.; Santori, E. A.; Lewis, N. S., Solar water splitting cells. *Chem. Rev.* **2010**, *110* (11), 6446-6473.
4. Tachibana, Y.; Vayssieres, L.; Durrant, J. R., Artificial photosynthesis for solar water-splitting. *Nat. Photonics* **2012**, *6* (8), 511.
5. Sivula, K.; Le Formal, F.; Grätzel, M., Solar water splitting: progress using hematite ( $\alpha\text{-Fe}_2\text{O}_3$ ) photoelectrodes. *ChemSusChem* **2011**, *4* (4), 432-449.
6. Sharma, P.; Jang, J. W.; Lee, J. S., Key Strategies to Advance the Photoelectrochemical Water Splitting Performance of  $\alpha\text{-Fe}_2\text{O}_3$  Photoanode. *ChemCatChem* **2019**, *11* (1), 157-179.
7. Monllor-Satoca, D.; Bärtzsch, M.; Fabrega, C.; Genç, A.; Reinhard, S.; Andreu, T.; Arbiol, J.; Niederberger, M.; Morante, J. R., What do you do, titanium? Insight into the role of titanium oxide as a water oxidation promoter in hematite-based photoanodes. *Energy Environ. Sci.* **2015**, *8* (11), 3242-3254.
8. Yang, X.; Liu, R.; Du, C.; Dai, P.; Zheng, Z.; Wang, D., Improving hematite-based photoelectrochemical water splitting with ultrathin  $\text{TiO}_2$  by atomic layer deposition. *ACS Appl. Mater. Interf.* **2014**, *6* (15), 12005-12011.
9. Boscherini, F., X-ray absorption fine structure in the study of semiconductor heterostructures and nanostructures. In *Characterization of Semiconductor Heterostructures and Nanostructures*, Elsevier: **2008**; pp 289-330.
10. Mobilio, S.; Boscherini, F.; Meneghini, C., *Synchrotron Radiation*. Springer: **2016**.
11. Schnohr, C. S.; Ridgway, M. C., *X-ray absorption spectroscopy of semiconductors*. Springer: **2015**.
12. Tang, P.; Arbiol, J., Engineering surface states of hematite based photoanodes for boosting photoelectrochemical water splitting. *Nanoscale Horiz.* **2019**, *4* (6), 1256-1276.
13. Dalle Carbonare, N.; Boaretto, R.; Caramori, S.; Argazzi, R.; Dal Colle, M.; Pasquini, L.; Bertinello, R.; Marelli, M.; Evangelisti, C.; Bignozzi, C. A., Photoelectrochemical Behavior of Electrophoretically Deposited Hematite Thin Films Modified with Ti (IV). *Molecules* **2016**, *21* (7), 942.
14. Zong, X.; Thaweesak, S.; Xu, H.; Xing, Z.; Zou, J.; Lu, G. M.; Wang, L., A scalable colloidal approach to prepare hematite films for efficient solar water splitting. *Phys. Chem. Chem. Phys.* **2013**, *15* (29), 12314-12321.
15. Cristino, V.; Berardi, S.; Caramori, S.; Argazzi, R.; Carli, S.; Meda, L.; Tacca, A.; Bignozzi, C. A., Efficient solar water oxidation using photovoltaic devices functionalized with earth-abundant oxygen evolving catalysts. *Phys. Chem. Chem. Phys.* **2013**, *15* (31), 13083-13092.
16. Dalle Carbonare, N.; Cristino, V.; Berardi, S.; Carli, S.; Argazzi, R.; Caramori, S.; Meda, L.; Tacca, A.; Bignozzi, C. A., Hematite photoanodes modified with an FeIII water oxidation catalyst. *ChemPhysChem* **2014**, *15* (6), 1164-1174.
17. Dalle Carbonare, N.; Carli, S.; Argazzi, R.; Orlandi, M.; Bazzanella, N.; Miotello, A.; Caramori, S.; Bignozzi, C. A., Improvement of the electron collection efficiency in porous hematite using a thin iron oxide underlayer: towards efficient all-iron based photoelectrodes. *Phys. Chem. Chem. Phys.* **2015**, *17* (44), 29661-29670.
18. Ravel, B.; Newville, M., ATHENA, ARTEMIS, HEPHAESTUS: data analysis for X-ray absorption spectroscopy using IFEFFIT. *J. Synchrotron Radiat.* **2005**, *12* (4), 537-541.
19. Wojdyr, M., Fityk: a general-purpose peak fitting program. *J. Appl. Crystallogr.* **2010**, *43* (5-1), 1126-1128.
20. Malara, F.; Minguzzi, A.; Marelli, M.; Morandi, S.; Psaro, R.; Dal Santo, V.; Naldoni, A.,  $\alpha\text{-Fe}_2\text{O}_3/\text{NiOOH}$ : an effective heterostructure for photoelectrochemical water oxidation. *ACS catalysis* **2015**, *5* (9), 5292-5300.
21. Klinger, M., More features, more tools, more CrysTBox. *J. Appl. Crystallogr.* **2017**, *50* (4), 1226-1234.
22. Wong, S.-T.; Lee, J.-F.; Cheng, S.; Mou, C.-Y., In-situ study of MCM-41-supported iron oxide catalysts by XANES and EXAFS. *Appl. Catal. A: Gen.* **2000**, *198* (1-2), 115-126.

1  
2  
3  
4  
5  
6  
7  
8  
9  
10  
11  
12  
13  
14  
15  
16  
17  
18  
19  
20  
21  
22  
23  
24  
25  
26  
27  
28  
29  
30  
31  
32  
33  
34  
35  
36  
37  
38  
39  
40  
41  
42  
43  
44  
45  
46  
47  
48  
49  
50  
51  
52  
53  
54  
55  
56  
57  
58  
59  
60

23. Blake, R.; Hessevick, R.; Zoltai, T.; Finger, L. W., Refinement of the hematite structure. *Am. Mineral.* **1966**, *51* (1-2), 123-129.
24. Chen, S.; Huang, M.; Lin, P.; Jeng, H.; Lee, J.; Haw, S.; Chen, S.; Lin, H.; Lu, K.; Chen, D., Orbital structure of FeTiO<sub>3</sub> ilmenite investigated with polarization-dependent X-ray absorption spectroscopy and band structure calculations. *Appl. Phys. Lett.* **2013**, *102* (4), 042107.
25. Luca, V.; Djajanti, S.; Howe, R. F., Structural and electronic properties of sol-gel titanium oxides studied by X-ray absorption spectroscopy. *J. Phys. Chem. B* **1998**, *102* (52), 10650-10657.
26. Wu, Z.; Ouvrard, G.; Gressier, P.; Natoli, C., Ti and OK edges for titanium oxides by multiple scattering calculations: Comparison to XAS and EELS spectra. *Phys. Rev. B* **1997**, *55* (16), 10382.
27. Cabaret, D.; Bordage, A.; Juhin, A.; Arfaoui, M.; Gaudry, E., First-principles calculations of X-ray absorption spectra at the K-edge of 3d transition metals: an electronic structure analysis of the pre-edge. *Phys. Chem. Chem. Phys.* **2010**, *12* (21), 5619-5633.
28. Henderson, G. S.; De Groot, F. M.; Moulton, B. J., X-ray absorption near-edge structure (XANES) spectroscopy. *Rev. Mineral. Geochem.* **2014**, *78* (1), 75-138.
29. Gu, D.; Qin, Y.; Wen, Y.; Qin, L.; Seo, H. J., Photochemical and magnetic activities of FeTiO<sub>3</sub> nanoparticles by electro-spinning synthesis. *J. Taiwan Inst. Chem. E.* **2017**, *78*, 431-437.
30. Deng, J.; Lv, X.; Liu, J.; Zhang, H.; Nie, K.; Hong, C.; Wang, J.; Sun, X.; Zhong, J.; Lee, S.-T., Thin-layer Fe<sub>2</sub>TiO<sub>5</sub> on hematite for efficient solar water oxidation. *ACS Nano* **2015**, *9* (5), 5348-5356.
31. Tang, P.; Xie, H.; Ros, C.; Han, L.; Biset-Peiró, M.; He, Y.; Kramer, W.; Rodríguez, A. P.; Saucedo, E.; Galán-Mascarós, J. R., Enhanced photoelectrochemical water splitting of hematite multilayer nanowire photoanodes by tuning the surface state via bottom-up interfacial engineering. *Energy Environ. Sci.* **2017**, *10* (10), 2124-2136.
32. Matoba, T.; Fujita, K.; Murai, S. In *Structure and magnetic properties of Fe<sub>2</sub>O<sub>3</sub>-FeTiO<sub>3</sub> films*, Journal of Physics: Conference Series, 2010; p 072029.
33. Robinson, P.; Harrison, R. J.; McEnroe, S. A.; Hargraves, R. B., Nature and origin of lamellar magnetism in the hematite-ilmenite series. *Am. Mineral.* **2004**, *89* (5-6), 725-747.
34. Kim, Y. J.; Gao, B.; Han, S. Y.; Jung, M. H.; Chakraborty, A. K.; Ko, T.; Lee, C.; Lee, W. I., Heterojunction of FeTiO<sub>3</sub> nanodisc and TiO<sub>2</sub> nanoparticle for a novel visible light photocatalyst. *J. Phys. Chem. C* **2009**, *113* (44), 19179-19184.
35. Chen, J.; Li, Z.; Ma, Y.; Sun, T., Visible Light-driven FeTiO<sub>3</sub>/TiO<sub>2</sub> Composite Materials for Pollutant Photodegradation. *Chem. Lett.* **2016**, *45* (11), 1319-1320.
36. Wang, J.; Xue, C.; Yao, W.; Liu, J.; Gao, X.; Zong, R.; Yang, Z.; Jin, W.; Tao, D., MOF-derived hollow TiO<sub>2</sub>@C/FeTiO<sub>3</sub> nanoparticles as photoanodes with enhanced full spectrum light PEC activities. *Appl. Catal. B: Environ.* **2019**, *250*, 369-381.
37. Barroso, M.; Pendlebury, S. R.; Cowan, A. J.; Durrant, J. R., Charge carrier trapping, recombination and transfer in hematite ( $\alpha$ -Fe<sub>2</sub>O<sub>3</sub>) water splitting photoanodes. *Chem. Sci.* **2013**, *4* (7), 2724-2734.
38. Orlandi, M.; Dalle Carbonare, N.; Caramori, S.; Bignozzi, C. A.; Berardi, S.; Mazzi, A.; El Koura, Z.; Bazzanella, N.; Patel, N.; Miotello, A., Porous versus compact nanosized Fe (III)-based water oxidation catalyst for photoanodes functionalization. *ACS Appl. Mater. Interf.* **2016**, *8* (31), 20003-20011.
39. Klahr, B.; Gimenez, S.; Fabregat-Santiago, F.; Bisquert, J.; Hamann, T. W., Electrochemical and photoelectrochemical investigation of water oxidation with hematite electrodes. *Energy Environ. Sci.* **2012**, *5* (6), 7626-7636.
40. Peter, L. M.; Wijayantha, K. U.; Tahir, A. A., Kinetics of light-driven oxygen evolution at  $\alpha$ -Fe<sub>2</sub>O<sub>3</sub> electrodes. *Faraday Discuss.* **2012**, *155*, 309-322.
41. de Carvalho, V. A.; Luz, R. A. d. S.; Lima, B. H.; Crespilho, F. N.; Leite, E. R.; Souza, F. L., Highly oriented hematite nanorods arrays for photoelectrochemical water splitting. *J. Power Sources* **2012**, *205*, 525-529.
42. Kavan, L.; Grätzel, M., Highly efficient semiconducting TiO<sub>2</sub> photoelectrodes prepared by aerosol pyrolysis. *Electrochim. Acta* **1995**, *40* (5), 643-652.
43. Bisquert, J.; Fabregat-Santiago, F.; Mora-Seró, I.; Garcia-Belmonte, G.; Barea, E. M.; Palomares, E., A review of recent results on electrochemical determination of the density of electronic states of

- 1  
2  
3 nanostructured metal-oxide semiconductors and organic hole conductors. *Inorg. Chim. Acta* **2008**, *361* (3),  
4 684-698.
- 5 44. Pu, A.; Deng, J.; Li, M.; Gao, J.; Zhang, H.; Hao, Y.; Zhong, J.; Sun, X., Coupling Ti-doping and oxygen  
6 vacancies in hematite nanostructures for solar water oxidation with high efficiency. *J. Mater. Chem. A* **2014**,  
7 *2* (8), 2491-2497.
- 8 45. Wang, Z.; Mao, X.; Chen, P.; Xiao, M.; Monny, S. A.; Wang, S.; Konarova, M.; Du, A.; Wang, L.,  
9 Understanding the roles of oxygen vacancies in hematite-based photoelectrochemical processes. *Angew.*  
10 *Chem.* **2019**, *131* (4), 1042-1046.
- 11 46. Marusak, L. A.; Messier, R.; White, W. B., Optical absorption spectrum of hematite,  $\alpha\text{-Fe}_2\text{O}_3$  near IR  
12 to UV. *J. Phys. Chem. Solids* **1980**, *41* (9), 981-984.
- 13 47. Klahr, B.; Gimenez, S.; Fabregat-Santiago, F.; Hamann, T.; Bisquert, J., Water oxidation at hematite  
14 photoelectrodes: the role of surface states. *Journal of the American Chemical Society* **2012**, *134* (9), 4294-  
15 4302.
- 16 48. Orlandi, M.; Berardi, S.; Mazzi, A.; Caramori, S.; Boaretto, R.; Nart, F.; Bignozzi, C. A.; Bazzanella,  
17 N.; Patel, N.; Miotello, A., Rational Design Combining Morphology and Charge-Dynamic for Hematite/Nickel-  
18 Iron Oxide Thin-Layer Photoanodes: Insights into the Role of the Absorber/Catalyst Junction. *ACS Applied*  
19 *Materials Interfaces* **2019**, *11* (51), 48002-48012.
- 20 49. Zandi, O.; Klahr, B. M.; Hamann, T. W., Highly photoactive Ti-doped  $\alpha\text{-Fe}_2\text{O}_3$  thin film electrodes:  
21 resurrection of the dead layer. *Energy Environ. Sci.* **2013**, *6* (2), 634-642.
- 22 50. Wijayantha, K. U.; Saremi-Yarahmadi, S.; Peter, L. M., Kinetics of oxygen evolution at  $\alpha\text{-Fe}_2\text{O}_3$   
23 photoanodes: a study by photoelectrochemical impedance spectroscopy. *Phys. Chem. Chem. Phys.* **2011**, *13*  
24 (12), 5264-5270.
- 25 51. Dias, P.; Andrade, L.; Mendes, A., Hematite-based photoelectrode for solar water splitting with very  
26 high photovoltage. *Nano Energy* **2017**, *38*, 218-231.
- 27  
28  
29  
30  
31  
32  
33  
34  
35  
36  
37  
38  
39  
40  
41  
42  
43  
44  
45  
46  
47  
48  
49  
50  
51  
52  
53  
54  
55  
56  
57  
58  
59  
60

## Graphical Table Of Contents



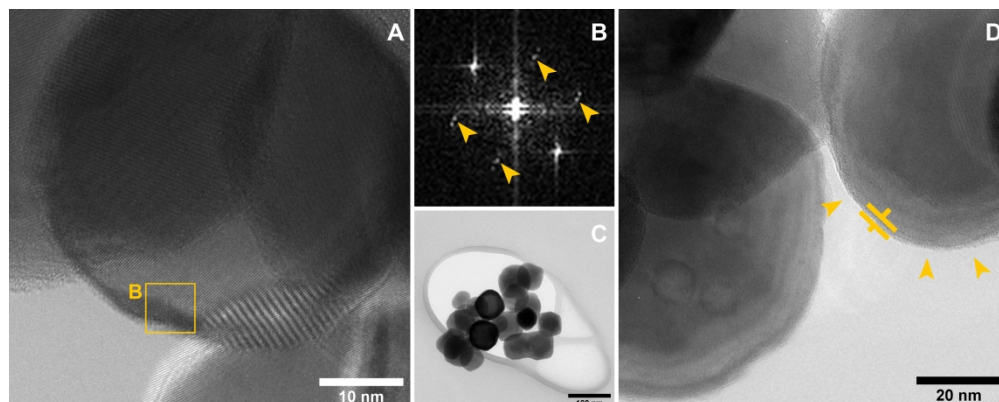


Figure 5 (high resolution version of an electron microscopy image; caption is provided in the manuscript)