

**Targeting cyclic nucleotide phosphodiesterase 5 (PDE5) in brain:  
Toward the development of a PET radioligand labeled with fluorine-18**

Wenzel, B.; Liu, J.; Dukic-Stefanovic, S.; Deuther-Conrad, W.; Teodoro, R.; Ludwig, F.-A.;  
Chezal, J.-M.; Moreau, E.; Brust, P.; Maisoniai-Besset, A.;

Originally published:

January 2019

**Bioorganic Chemistry 86(2019), 346-362**

DOI: <https://doi.org/10.1016/j.bioorg.2019.01.037>

Perma-Link to Publication Repository of HZDR:

<https://www.hzdr.de/publications/Publ-28000>

Release of the secondary publication  
on the basis of the German Copyright Law § 38 Section 4.

CC BY-NC-ND

## Targeting cyclic nucleotide phosphodiesterase 5 (PDE5) in brain: Toward the development of a PET radioligand labeled with fluorine-18

Barbara Wenzel<sup>1§#</sup>, Jianrong Liu<sup>2#</sup>, Sladjana Dukic-Stefanovic<sup>1</sup>, Winnie Deuther-Conrad<sup>1</sup>, Rodrigo Teodoro<sup>1</sup>, Friedrich-Alexander Ludwig<sup>1</sup>, Jean-Michel Chezal<sup>2</sup>, Emmanuel Moreau<sup>2</sup>, Peter Brust<sup>1</sup>, Aurelie Maisonia-Besset<sup>2</sup>

<sup>1</sup> *Helmholtz-Zentrum Dresden-Rossendorf, Institute of Radiopharmaceutical Cancer Research, Department of Neuroradiopharmaceuticals, Leipzig, Germany;*

<sup>2</sup> *UMR 1240 INSERM IMOST, Université Clermont-Auvergne, Clermont-Ferrand, France*

*# These authors contributed equally to the work.*

*§ corresponding author*

### Abstract

With the aim to develop a specific radioligand for imaging the cyclic nucleotide phosphodiesterase 5 (PDE5) in brain by positron emission tomography (PET), seven new fluorinated inhibitors (**3** – **9**) were synthesized on the basis of a quinoline core. The inhibitory activity for PDE5 together with a panel of other PDEs was determined in vitro and two derivatives were selected for IC<sub>50</sub> value determination. The most promising compound **7** (IC<sub>50</sub> = 5.92 nM for PDE5A), containing a 3-fluoroazetidine moiety, was further radiolabeled by aliphatic nucleophilic substitution of two different leaving groups (nosylate and tosylate) using [<sup>18</sup>F]fluoride. The use of the nosylate precursor and tetra-*n*-butyl ammonium [<sup>18</sup>F]fluoride ([<sup>18</sup>F]TBAF) in 3-methyl-3-pentanol combined with the addition of a small amount of water proved to be the best radiolabeling conditions achieving a RCY of 4.9 ± 1.5% in an automated procedure. Preliminary biological investigations in vitro and in vivo were performed to characterize this new PDE5 radioligand. Metabolism studies of [<sup>18</sup>F]**7** in mice revealed a fast metabolic degradation with the formation of radiometabolites which have been detected in the brain.

Keywords: PDE5, <sup>18</sup>F-radiolabeling, nosylate, tosylate, <sup>18</sup>F-fluoroazetidine

## 1. Introduction

The cyclic nucleotide phosphodiesterases (PDEs) are a large family of enzymes that regulate intracellular levels of the two important second messengers cyclic adenosine 3',5'-monophosphate (cAMP) and cyclic guanosine 3',5'-monophosphate (cGMP) by cleavage of their phosphodiester bond. To date, 11 subtypes of these enzymes have been identified and classified mainly according to their amino acid sequences. Phosphodiesterase 5 (PDE5) is specific for cGMP which is generated by the nitric oxide (NO)-dependent soluble guanylate cyclase and activates the protein kinase G (PKG). PKG activation triggers phosphorylation of numerous intracellular proteins that in turn regulate many primary physiological functions such as modulation of vascular tone and vasorelaxation in vascular smooth muscle. This was the basis for the breakthrough of one of the most celebrated PDE5 inhibitors namely sildenafil (Viagra®) which is used as treatment for erectile dysfunction and chronic pulmonary hypertension. Moreover, currently this enzyme arouses increasing interest of clinical researchers as a multifunctional biomarker and drug target because PDE5 inhibition also affects neurodegenerative [1] and cancerous processes [2]. For example, increased PDE5 levels have been reported in several carcinomas including colon adenocarcinoma, bladder squamous carcinoma, thyroid tumors, metastatic breast, prostate, pancreatic, bladder and lung cancers [3-9]. As it was demonstrated, that cGMP can reduce cell growth and induce apoptosis [10, 11], and that PDE5 catalyzes the degradation of cGMP, this enzyme has been suggested to be involved in tumor progression because its elevation goes along with increasing tumor grade and stage [4, 12]. Moreover, PDE5 inhibitors are able to enhance the chemotherapeutic efficacy of anticancer drugs in different tumors and cancer cell types [9, 13-15] and inhibition of PDE5 has an impact on the attenuation of multidrug resistance, one of the major causes of unsuccessful anticancer treatments [16, 17].

Despite the tremendous growth of preclinical and clinical studies on the use of PDE5 inhibitors and their promising results, the mechanisms of action are in most cases not fully understood and detailed insights are needed. For example, the currently available data are insufficient to make any conclusive statement regarding the exact role of the PDE5 enzyme in cancer pathogenesis [12, 18].

The aim of our research is the development of a PDE5-specific radioligand to support in vitro and in vivo studies on the investigation of pathology-specific changes in the availability of the enzyme using PET. Regarding tumor imaging, those studies would enable the assessment of the spatiotemporal pattern of PDE5 expression. Thereby, our particular interest is dedicated to a future investigation of brain tumors by characterizing the expression of PDE5 in healthy and diseased brain.

In recent years, several attempts have been made to develop PET radioligands targeting the PDE5 enzyme as reviewed elsewhere [19, 20]. Most of the radiotracers are labeled with carbon-11 and suffer from a lack of specificity [21, 22]. Chekol et al. reported on the development of fluorine-18 labeled PDE5 radioligands [23, 24]. In particular a vardenafil-based derivative showed a high retention in the lungs which was interpreted to be PDE5-specific because of the high expression of PDE5 in this organ [23]. Biodistribution studies in mice showed that none of the ligands investigated in this study demonstrated significant brain uptake. By contrast, a recent report by the same group revealed that a pyridopyrazinone based <sup>18</sup>F-labeled derivative has shown accumulation in rat brain. Although the radiotracer readily entered the brain, the radioactivity uptake was not specific toward PDE5. On the other hand, this compound demonstrated specific binding in transgenic mice with cardiomyocyte-specific PDE5 overexpression [24].

Searching for a suitable lead compound for the development of a brain penetrating PDE5 radioligand, we decided to focus our attention on the heterocyclic quinoline based compounds **1** and **2** (Figure 1). These derivatives were described with a high PDE5 potency and the potential to cross the blood-brain barrier [25, 26]. Structure-activity relationship studies (SAR) revealed important structural features of this family of PDE5 inhibitors [25, 26]. The quinoline scaffold bearing a hydroxymethyl group at position C-3 ("east region") improves the inhibitory activity on PDE5 and the solubility compared to the other core ring systems tested. The binding to the protein is highly dependent on the presence of the secondary amino functionality at position C-4 ("north region") [27]. Moreover, the influence of a combination of different substituents on positions C-6 and C-8 of the quinoline scaffold was studied resulting in the so far most potential candidates **1** [25] and **2** [26]. Based on these results, we started our attempts to introduce a fluorine containing structural moiety at the "east region" of **1** and **2** by substituting the hydroxymethyl group on C-3 by a fluoroethyl and fluoroethoxymethyl group [28], resulting in the development of the new PDE5 radioligand

[<sup>18</sup>F]ICF24027 [29]. However, due to the fast formation of a brain-penetrable radiometabolite, this radiotracer was not suitable for PDE5 imaging in brain. The aim of the present study was to investigate the possibility of introducing fluorine containing moieties at the "north" or "south region" (position 4 or 8) of the quinoline scaffold (Figure 1) in order to develop a specific and metabolically more stable <sup>18</sup>F-labeled radioligand for imaging of the PDE5 enzyme in brain.

## 2. Results and discussion

### 2.1. Ligand development

#### 2.1.1. Concept

For introduction of the fluorine atom at the "north region" of the lead structures **1** and **2**, modification of the chlorobenzene scaffold was intended (Figure 1). As the secondary amine substituted at the C-4 position of the quinoline core is known to be crucial for the PDE5 inhibitory activity [27], it was not considered for an alkylation with a fluorinated alkyl side chain. In order to enable a straightforward radiofluorination, the substitution of a 2-fluoro-3-methoxypyridine ring was favored (**3** and **4**). This strategy allows nucleophilic heteroaromatic substitution with [<sup>18</sup>F]fluoride using synthetic easily accessible halogen or nitro substituted precursor compounds [30].

Structural modifications performed at the "south region" of the lead compound **1** usually have a minor impact on the PDE5 inhibitory activity [26]. Therefore, we selected four structurally diverse moieties to introduce the fluorine at the C-8 position of the quinoline core by substituting the ethyl group of **1** as follows (Figure 1): (i) fluoropropyl alkyl chain (**5**), (ii) 4-fluoropiperidine (**6**) and (iii) 3-fluoroazetidine (**7**) as aliphatic rings and (iv) 2-fluoropyridines (**8** and **9**) as aromatic rings.

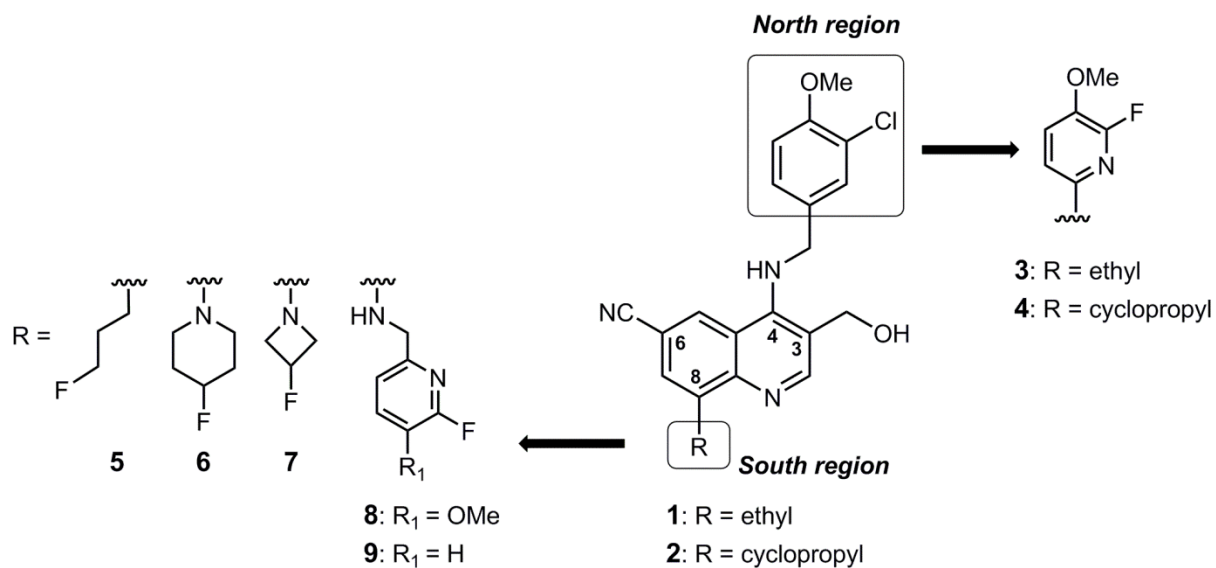

**Figure 1.** Design of fluorinated compounds with introduction of the fluorine atom on substituents located at C-4 or C-8 position of the quinoline core of the lead compounds **1** and **2**.

### 2.1.2. Organic Chemistry

The synthesis of derivatives **3** and **4** bearing modifications in the "north region" of the quinoline scaffold, started with the coupling of amine **10a** with the 4-chloroquinoline **11** via aromatic nucleophilic substitution at the C-4 position of the quinoline ring (Scheme 1). 4-Chloroquinoline **11** was prepared as previously described by our group [28]. The necessary amine **10a** was synthesized in 5 steps according to known procedures (see supporting information). The resulting derivative **12** was further functionalized at the C-8 position via a Suzuki-Miyaura cross-coupling reaction with commercially available ethylboronic or cyclopropylboronic acid to generate **13a** and **13b** with a yield of 68% and 86%, respectively. The desired fluorinated compounds **3** and **4** were obtained by a selective reduction of the ester function with lithium tri-*tert*-butoxyaluminum hydride (LTBA).

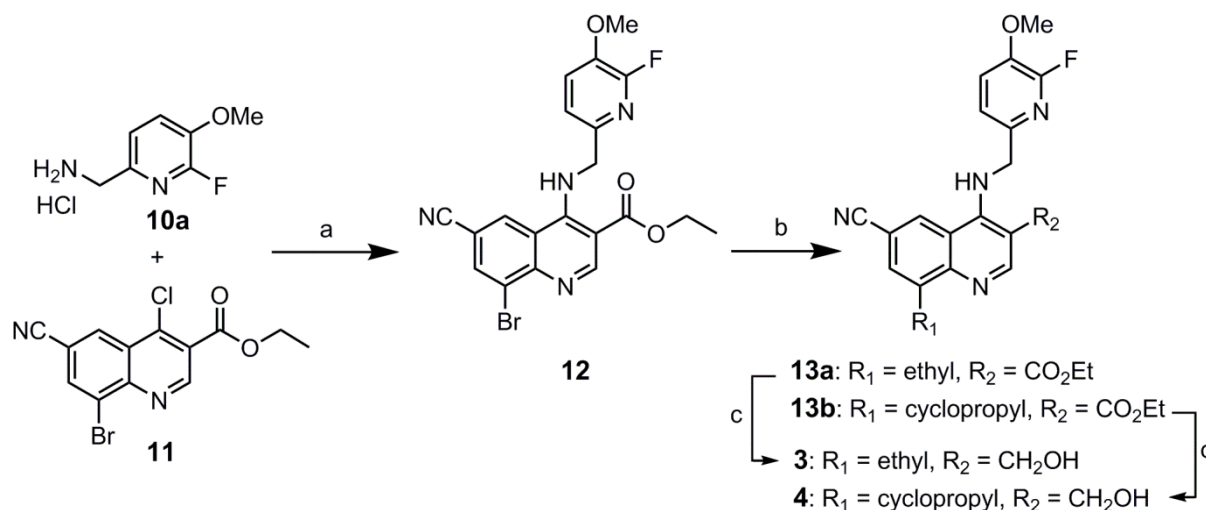

**Scheme 1.** Synthesis of "north region" compounds **3** and **4**.

Reagents and conditions: (a) **10a**, *N,N*-diisopropylethylamine (DIPEA), *n*-propanol, reflux, 2 h; (b) ethylboronic acid for **13a** and cyclopropylboronic acid for **13b**, Pd(PPh<sub>3</sub>)<sub>4</sub>, Cs<sub>2</sub>CO<sub>3</sub>, toluene, reflux, 15–22 h; (c) LTBA, THF, 50 °C, 30 h.

For the synthesis of compounds **5–9** modified at the C-8 position of the quinoline core, two different palladium-catalyzed reaction pathways were developed in order to form the C-C bond in **5** and the C-N bond in **6–9** starting from compound **14** [28]. The synthesis of **5** started with the reaction of allyl alcohol with 9-borabicyclo[3.3.1]nonane (9-BBN) in tetrahydrofuran to afford the corresponding boronic ester, generated in situ at the  $\alpha$ -position of the alkene reactant. This complex was used directly for the subsequent Suzuki-Miyaura cross-coupling reaction with **14** (Scheme 2, strategy 1) to afford the alcohol **15** with a yield of 26%. It is worth mentioning, that the concomitant formation of the debrominated analog of **14** was observed in a ratio of about 1/1.

To further convert the alcohol function into fluorine, **15** was treated by diethylaminosulfur trifluoride (DAST) under classical conditions. However, the formation of the desired fluorinated product **16** could not be observed and only a by-product, identified as compound **17**, was obtained with a yield of 57%. We assume the formation of this stable six-membered ring in **17** is a result of an intramolecular cyclization caused by the electron donor effects of the free secondary amine located at the C-4 position of the quinoline, as previously observed during the chemical modifications at the "east region" of this compound class [28]. Therefore, an alternative strategy (Scheme 2, strategy 2) was developed, in which the amine at the C-4 position of **14** was beforehand protected using di-*tert*-butyl dicarbonate (Boc<sub>2</sub>O) in the presence of catalytic amounts of *N,N*-4-dimethylaminopyridine (DMAP) to obtain **18** with a

yield of 74%. For the following Suzuki-Miyaura coupling at C-8 position, a fluorinated boronic ester was used, generated from the reaction of allyl bromide with tetra-*n*-butylammonium fluoride (TBAF) and 9-BBN. Thus, the fluoroalkylated compound **19** was successfully synthesized and used in the next synthesis step without further purification. Finally, the ester group was converted into the corresponding alcohol to obtain **20** which was treated with trifluoroacetic acid (TFA) to remove the Boc protecting group resulting in the desired derivative **5** with a yield of 31%.

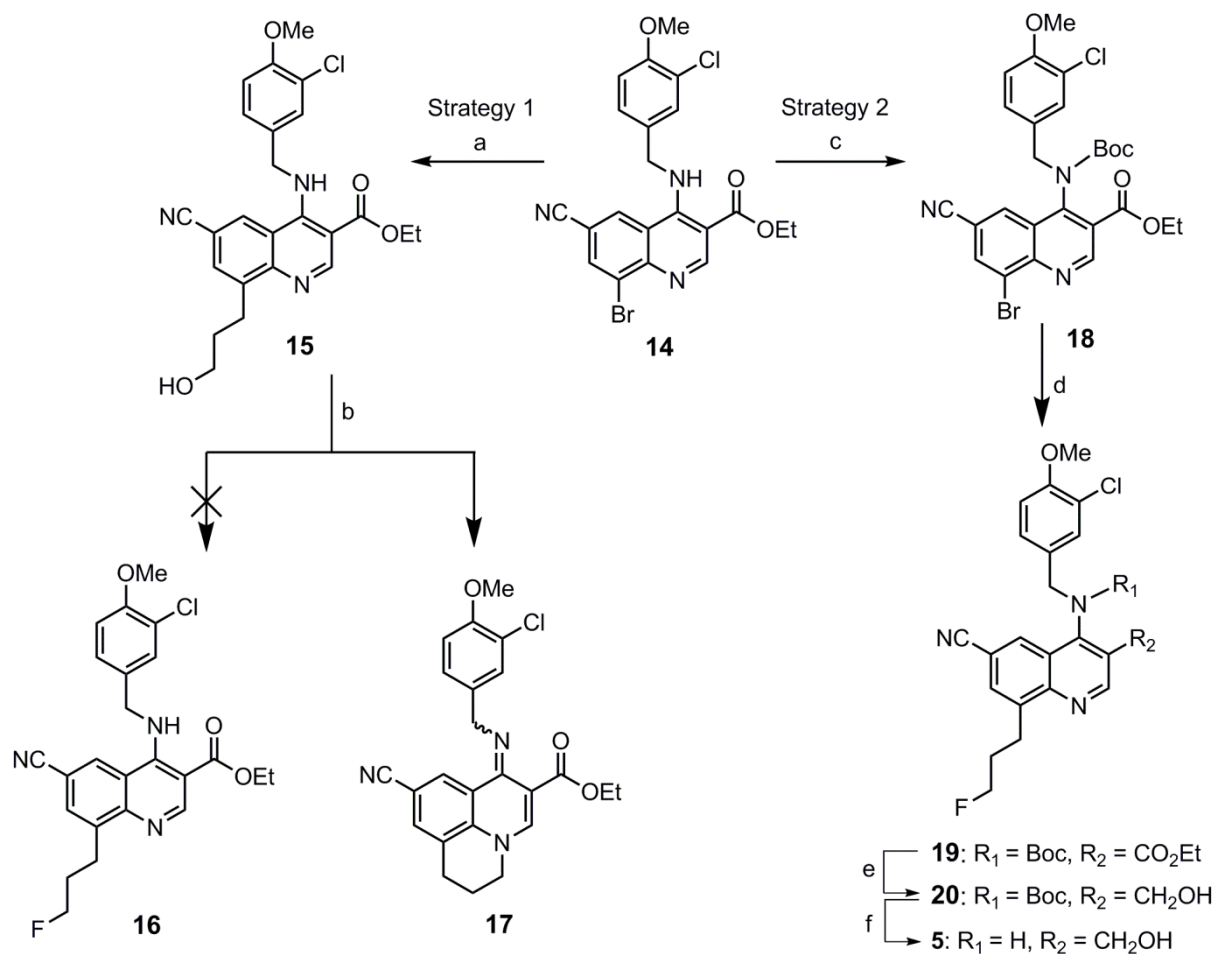

**Scheme 2.** Synthesis of "south region" compound **5**.

Reagents and conditions: (a) 1) Allyl alcohol, 9-borabicyclo[3.3.1]nonane (9-BBN), THF, 0 °C → rt, 7 h; 2) Pd(PPh<sub>3</sub>)<sub>4</sub>, K<sub>2</sub>CO<sub>3</sub>, H<sub>2</sub>O, DMF, 80 °C, 22 h; (b) Diethylaminosulfur trifluoride (DAST), CH<sub>2</sub>Cl<sub>2</sub>, -60 °C → -30 °C, 2 h; (c) (Boc)<sub>2</sub>O, DMAP, Et<sub>3</sub>N, THF, rt, 2.5 h; (d) 1) Allyl bromide (reagent and solvent), TBAF, rt, 30 min; 2) 9-BBN, THF, -10 °C → rt, 7 h; 3) Pd(PPh<sub>3</sub>)<sub>4</sub>, K<sub>2</sub>CO<sub>3</sub>, H<sub>2</sub>O, DMF, 80 °C, 16 h; (e) LTBA, THF, 60 °C, 20 h; (f) TFA/CH<sub>2</sub>Cl<sub>2</sub>, 1/2, v/v, rt, 3 h.

For the synthesis of compounds **6-9** via C-N bond formation at the C-8 position of compound **14** (Scheme 3), the Buchwald-Hartwig coupling reaction was used. Therefore, **14** was treated with commercially available 4-fluoropiperidine, 3-fluoroazetidine and the synthesized



pyridines **10a**, **b** (see supporting information) to afford **21a-d** in 56-93% yields. Further reduction of the ester function to the corresponding alcohol with LTBA provided the desired fluorinated compounds **6-9**.

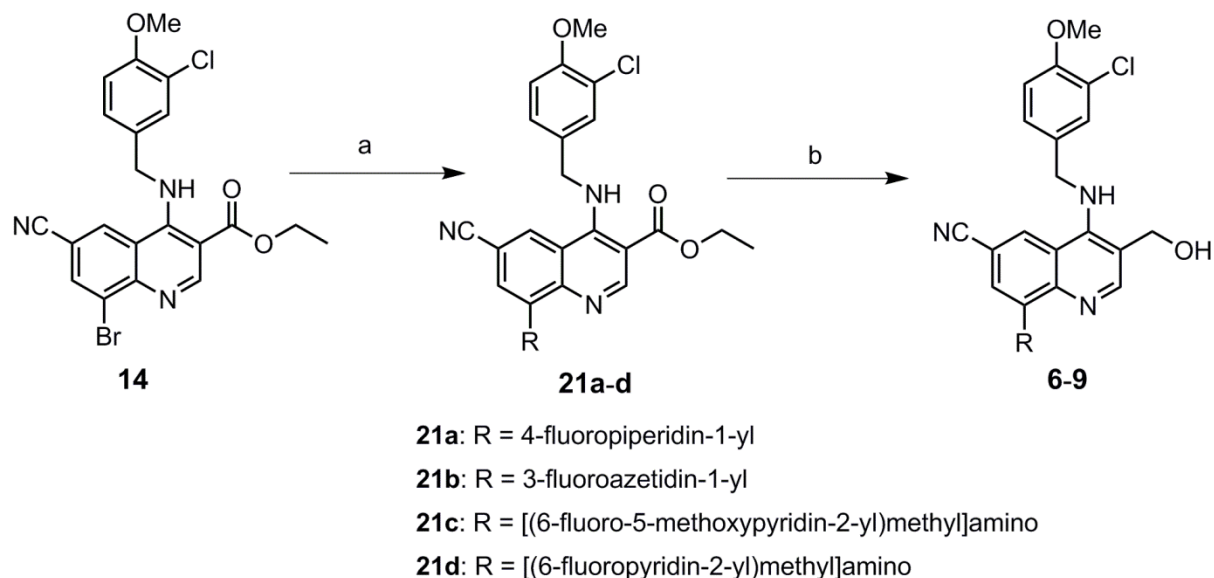

**Scheme 3.** Synthesis of "south region" compounds **6-9**.

Reagents and conditions: (a) 4-fluoropiperidine hydrochloride for **21a**, 3-fluoroazetidine hydrochloride for **21b**, **10a** for **21a** and **10b** for **21b**, Pd(OAc)<sub>2</sub>, BINAP, Cs<sub>2</sub>CO<sub>3</sub>, toluene, 120 °C, 3 h for **21a** and **b**, 16 h for **21c** and 4 h for **21d**; (b) LTBA, THF, 60 °C, 20 h.

## 2.2. Determination of inhibitory activity

The inhibitory potential of the new fluorinated derivatives **3-9** on the human recombinant PDE5A1 protein and selected other human PDEs were evaluated by using an enzyme assay [31] with sildenafil as standard reference compound. The tests were performed at two different concentrations of the compounds; 100 nM for PDE5A1 and 1.0 μM for the other PDEs. The results are summarized in Table 1. Analyses of the data revealed a considerable decrease of PDE5A1 potency for derivatives **3** and **4** (34.6 and 20.9% of inhibition, respectively) compared to the lead compounds **1** and **2** (90.3 and 84.2%, respectively). Hence, the substitution of the 3-chloro-4-methoxy phenyl ring by a 2-fluoro-3-methoxy pyridine ring in the "north region" of the molecule is unfavorable for binding to the PDE5A1 protein. By contrast, derivatives **5-9** are characterized by structural modifications in the "south region" at C8 of the quinoline core. Although the introduced motifs are structurally quite diverse, their influence on the inhibitory activity toward the PDE5A1 is rather low and the obtained values do not differ considerably compared to **1** and **2**. This is in accordance with the results reported

by Fiorito et al. [26], who also modified the functionalities at the C8-position. All new derivatives **3-9** demonstrated a high selectivity for the PDE5 enzyme as shown by the weak inhibitory potential against PDE2A3, PDE3A, PDE4A1 and C2, PDE6AB, PDE9A1, PDE10A1, and PDE11A1 at 1  $\mu$ M concentrations.

As derivatives **6** and **7** showed the highest inhibition values for PDE5A1, they were selected for determination of IC<sub>50</sub> values by measuring the inhibition at seven different concentrations (0.25 – 1000 nM) [31]. With an IC<sub>50</sub> value of 5.92 nM compound **7** showed the highest inhibitory potential which is comparable to sildenafil (IC<sub>50</sub> = 6.23 nM). Although the inhibitory activity of **7** is slightly lower compared to our first developed radiotracer [<sup>18</sup>F]ICF24027 [28, 29], this compound demonstrated a good selectivity toward the other PDEs and was therefore selected for <sup>18</sup>F-labeling to generate a potential radiotracer for PET imaging of PDE5A.

Table 1. Percentage inhibition values of synthesized compounds against selected PDEs

Comp.	Percentage of inhibition (%)									IC <sub>50</sub> (PDE5A1) (nM)
	PDE2A3 <sup>a</sup>	PDE3A <sup>a</sup>	PDE4A1 <sup>a</sup>	PDE4C2 <sup>a</sup>	PDE5A1 <sup>b</sup>	PDE6AB <sup>a</sup>	PDE9A1 <sup>a</sup>	PDE10A1 <sup>a</sup>	PDE11A1 <sup>a</sup>	
<b>1</b> <sup>c</sup>	22.4	NI	45.4	40.9	90.3	49.8	NI	40.0	27.2	
<b>2</b> <sup>c</sup>	15.3	NI	36.9	22.4	84.2	32.4	NI	22.9	24.1	
<b>3</b>	10.4	NI	33.4	4.52	34.6	35.9	2.87	27.9	11.8	n.d.
<b>4</b>	14.1	NI	22.2	15.9	20.9	23.2	NI	15.8	8.80	n.d.
<b>5</b>	16.0	NI	37.3	18.6	80.7	NI	NI	46.8	16.4	n.d.
<b>6</b>	17.0	NI	36.8	35.3	87.8	24.7	20.6	17.4	23.7	25.6
<b>7</b>	18.9	NI	18.3	16.1	90.3	10.8	8.71	23.5	13.2	5.92
<b>8</b>	76.6	NI	28.6	15.3	64.2	13.9	23.4	17.2	8.82	n.d.
<b>9</b>	39.5	NI	24.5	18.7	80.5	5.79	NI	21.0	11.2	n.d.
ICF24027 <sup>c</sup>	7.49	18.2	9.03	32.4	88.4	60.4	NI	14.1	5.21	1.86
Sildenafil <sup>c</sup>	67.7	63.9	65.8	55.4	86.7	65.7	74.0	74.6	78.5	6.23

<sup>a</sup> The compounds were tested at 1  $\mu$ M against PDE2A3, PDE3A, PDE4A1, PDE4C2, PDE6AB, PDE9A1, PDE10A1 and PDE11A1 and <sup>b</sup> at 100 nM against human PDE5A1. NI means no inhibition; n.d. means not determined. <sup>c</sup> Own reported data [28].

### 2.3. Precursor synthesis and radiochemistry

For the synthesis of the new radioligand [<sup>18</sup>F]**7**, the aliphatic nucleophilic substitution reaction of a precursor with a suitable leaving group by [<sup>18</sup>F]fluoride was intended. As <sup>18</sup>F-labeling of an azetidine ring was only described in a single report [32], and the radiolabeling at a

secondary carbon atom is usually more challenging than on a primary carbon atom [33], we investigated the use of two sulfonate leaving groups with different reactivity. Therefore, the precursor molecules **27** and **28** with methylbenzenesulfonate (tosylate) and 4-nitrobenzenesulfonate (nosylate), respectively, were synthesized. According to the literature, the nosylate is known to be slightly more reactive than tosylate [34, 35].

Based on former experiments with this compound class (data not shown), the alcohol functionality was not protected as its acidity is expected to be too low to considerably influence the radiolabeling reaction.

### 2.3.1. Synthesis of the precursor compounds

The precursor compounds **27** and **28** were prepared as shown in Scheme 4. In a first step, the ester function of **14** was reduced to the corresponding alcohol **22**, which was further protected as a silyl ether group to give **23**. As described above for compound **21b**, the azetidine moiety was then coupled on the C-8 position of the quinoline core of derivative **23** using freshly prepared azetidin-3-ol trifluoroacetate [36] to produce compound **24** with a yield of 51%. Afterwards, the tosylation and nosylation reactions were performed under classical conditions to afford **25** and **26**, respectively. Finally, the triisopropyl silyl (TIPS) protecting group was cleaved in the presence of TBAF to afford the desired tosylate **27** and nosylate **28** precursors with yields in the range of 60-70%.

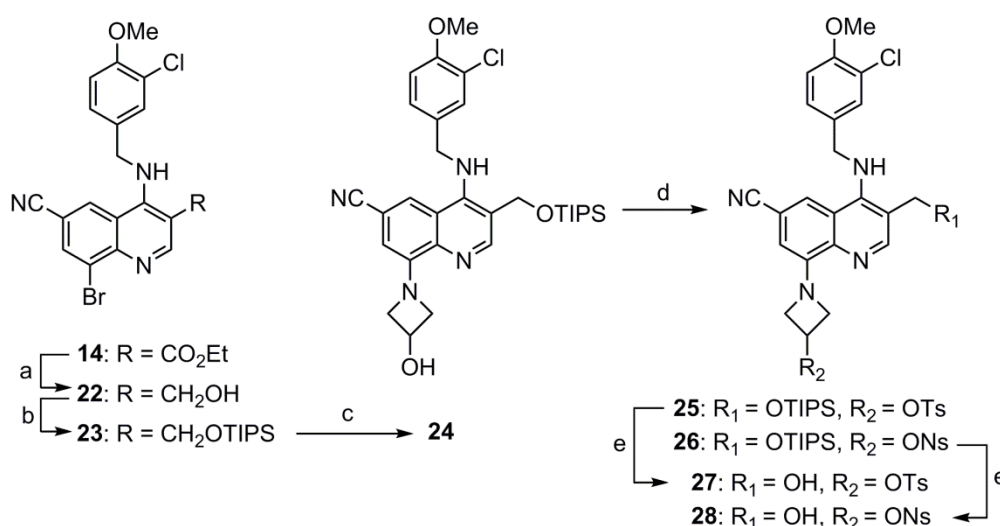

**Scheme 4.** Synthesis of precursor compounds **27** and **28** for <sup>18</sup>F-radiolabeling.

Reagents and conditions: (a) LTBA, THF, 60 °C, 20 h, (b) TIPSCl, Et<sub>3</sub>N, DMAP, DMF, rt, 36 h, (c) azetin-3-ol trifluoroacetate, Cs<sub>2</sub>CO<sub>3</sub>, 2,2'-bis(diphenylphosphino)-1,1'-binaphthyl (BINAP), Pd(OAc)<sub>2</sub>, toluene, reflux, 3 h, (d) TsCl for **25** or NsCl for **26**, Et<sub>3</sub>N, DMAP, DCM, rt, 19 h, (e) TBAF, THF, rt, 30 min.

## 2.3.2. Radiosyntheses

### 2.3.2.1. Methylbenzenesulfonate (OTs) as leaving group

The  $^{18}\text{F}$ -labeling of the tosylate precursor **27** was investigated with the conventional potassium carbonate ( $\text{K}_2\text{CO}_3$ ) - kryptofix-222 system ( $\text{K}[^{18}\text{F}]\text{F}/\text{K}_{222}$  complex) changing different reaction parameters (solvents, temperatures and reaction times). When the reaction was performed in acetonitrile (ACN) at 90 °C and in DMF at 130 or 150 °C, only the formation of by-products could be observed. Using DMSO at 130 °C resulted in the generation of  $^{18}\text{F}$ **7** with a radiochemical yield of 2 - 3% after 5 min (determined by radio TLC of a sample of the reaction mixture). However, the RCY decreased with increasing reaction time indicating a decomposition of the radiotracer. The same effect was observed for the precursor **27** itself, which was entirely decomposed after 15 min reaction time according to HPLC analysis, probably due to a competing  $\beta$ -elimination reaction. Further investigations revealed that 100 °C was the optimal temperature for this radiolabeling system resulting in RCYs of 3 - 4% after 15 min (Scheme 5). The reactions were performed with a precursor amount of 2.0 - 2.5 mg; higher concentrations of **27** did not result in an increase of RCY. Due to the presumed base sensitivity of both, the precursor and the radiotracer, potassium oxalate as less basic counter ion was tested in combination with  $\text{K}_{222}$  in DMSO. However, these conditions did not lead to the formation of  $^{18}\text{F}$ **7**. Moreover, we tested  $^{18}\text{F}$ TBAF as a mild nucleophilic  $^{18}\text{F}$ -fluorination agent in *tert*-amyl alcohol, as previously used by Zhang et al. for radiolabeling of the same azetidine motif in a PDE2A radioligand [32]. However, in contrast to the reported results (RCY of 7.3% at the end of the synthesis) we could not obtain the desired radiotracer  $^{18}\text{F}$ **7** under these conditions.

Finally, it turned out that using the  $\text{K}[^{18}\text{F}]\text{F}/\text{K}_{222}$  complex in DMSO was most useful for the synthesis of  $^{18}\text{F}$ **7** on the basis of a tosylate precursor and was therefore translated to an automated procedure using the TRACERlab FX2 N synthesis module (GE Healthcare). The synthesizer setup is described in the experimental part. Briefly, after trapping and elution of  $^{18}\text{F}$ fluoride by an aqueous potassium carbonate solution from an anion exchange cartridge, the labeling reaction of the azeotropically dried  $\text{K}[^{18}\text{F}]\text{F}/\text{K}_{222}$  complex with the precursor **27** was performed in DMSO for 15 min at 100 °C. For isolation of  $^{18}\text{F}$ **7**, the crude reaction mixture was diluted with aqueous acetonitrile and directly applied to a semi-preparative HPLC system (chromatogram in supporting information). The radiotracer fraction was collected at a

retention time of 22 - 24 min and purified by solid phase extraction (SPE) using a C18-cartridge. The obtained radiotracer eluate was transferred out of the hot cell, concentrated and formulated in sterile isotonic saline containing 10% of ethanol. In a total synthesis time of 80 min, [<sup>18</sup>F]**7** could be reproducibly produced with a high radiochemical purity of ≥ 99%, a radiochemical yield of 2.5 ± 0.1% (n = 3) and molar activities between 14 and 28 GBq/μmol (n = 3, end of synthesis EOS) with starting activities of 4 - 5 GBq. Co-injection of the corresponding reference compound **7** confirmed the identity of [<sup>18</sup>F]**7** by analytical radio-HPLC (chromatogram in supporting information).

#### **2.3.2.2. 4-Nitrobenzenesulfonate (ONs) as leaving group**

For <sup>18</sup>F-labeling of the nosylate precursor **28** we started as for the tosylate by using the K[<sup>18</sup>F]F/K<sub>222</sub> complex. Reactions were performed in ACN, DMF and DMSO at different temperatures (90 °C for ACN, 130 and 150 °C for DMF and DMSO, resp.) resulting in RCYs lower than 1%. Moreover, the tertiary alcohols *tert*-BuOH and 3-methyl-3-pentanol (3M3P) were tested, because nonpolar protic solvents are described to be beneficial for aliphatic nucleophilic substitution [37, 38] as e.g. reported for [<sup>18</sup>F]FLT [39, 40] and [<sup>18</sup>F]FES [41]. 3-Methyl-3-pentanol (3M3P) was recently used by Marchand et al. [40] because of its high boiling point of 123 °C avoiding an excessive pressure in the reactor. For the [<sup>18</sup>F]FLT synthesis, the ratio of nosylate precursor to base was also shown to be crucial for the labeling process [40, 42]. In the presence of an excess amount of base, the precursor is undergoing an E2 elimination mechanism, thus reducing the desired nucleophilic <sup>18</sup>F-fluorination [42]. Therefore, we started with a constant precursor to base ratio of 1.5 using 4 mg of precursor **28** and 0.6 mg of K<sub>2</sub>CO<sub>3</sub> as base. While reaction in *tert*-BuOH at 95 °C resulted in an RCY of 2%, a higher RCY of 7% could be achieved in 3M3P at 125 °C. With the aim to minimize the amount of precursor used, we further investigated the 3M3P system and found that a minimal ratio of 0.75 (2 mg precursor and 0.6 mg base) is necessary to achieve this RCY. However, when transferring this procedure to an automated process, we observed an insufficient elution of [<sup>18</sup>F]fluoride from the anion exchange cartridge with this low amount of base. To reduce the loss of activity on the cartridge to a minimum of 10%, 1.2 mg of K<sub>2</sub>CO<sub>3</sub> has been found to be necessary in our automated system, which would result in the undesired use of higher precursor amounts.

Because of the observed base sensitivity of the nosylate precursor **28**, [<sup>18</sup>F]TBAF was also investigated as fluorination agent. While in DMSO no radiolabeling could be obtained, an RCY of up to 10% was found in 3M3P at 125 °C with 2 mg of **28**. By chance we observed that small amounts of water favored this radiolabeling reaction. The presence of water in <sup>18</sup>F-fluorination reactions can positively influence the RCY as already described by different groups [43, 44] and has been explained with the dependence of the nucleophilicity of fluoride by its hydration state [45, 46]. Indeed, in our system the addition of 50 – 100 µL water to the reaction mixture (total volume 1 mL) increased the RCY up to 20% (Scheme 5). However, the addition of more water lead to a reduction of the RCY. Attempts to skip the azeotropic drying step by eluting the [<sup>18</sup>F]fluoride with tetra-*n*-butylammonium hydrogen carbonate (TBAHCO<sub>3</sub>) dissolved in the radiolabeling solvent 3M3P and 100 µL water failed due to the immiscibility of this tertiary alcohol and water.

Finally, the conditions were applied to an automated procedure using the TRACERlab FX2 N module. The detailed procedure is described in the experimental part. Briefly, after trapping on an anion exchange cartridge, the [<sup>18</sup>F]fluoride was eluted with TBAHCO<sub>3</sub> dissolved in an ACN/water solution and the resulting [<sup>18</sup>F]TBAF was dried by azeotropic distillation. The radiolabeling reaction was performed after addition of the nosylate precursor **28** dissolved in 3M3P/ACN/water (700/200/80, v/v/v) for 10 min at 125 °C. For isolation of [<sup>18</sup>F]**7** with semi-preparative HPLC, the solvent was removed under reduced pressure because a strong peak broadening was observed when the tertiary alcohol remained in the injection solution. After evaporation, the crude reaction mixture was diluted with aqueous acetonitrile and applied to a semi-preparative HPLC system (chromatogram in supporting information). The radiotracer fraction was collected at a retention time of 26 - 29 min and purified by solid-phase extraction (SPE) using a C18 cartridge. The obtained radiotracer eluate was transferred out of the hot cell, concentrated and formulated in sterile isotonic saline containing 10% of ethanol. The entire process for this radiosynthesis lasted about 85 min. Finally, [<sup>18</sup>F]**7** could be reproducibly produced with a high radiochemical purity of ≥ 99%, a radiochemical yield of 4.9 ± 1.5% (n = 3) and molar activities between 28 and 58 GBq/µmol (n = 3, EOS) with starting activities of 4 - 5 GBq. The identity of [<sup>18</sup>F]**7** was confirmed by analytical radio-HPLC (chromatogram in supporting information).

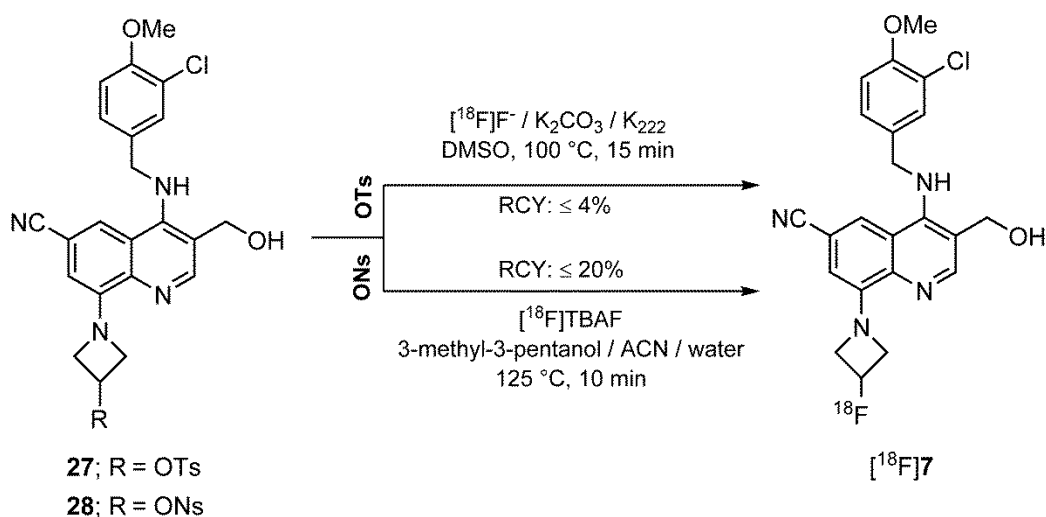

**Scheme 5.**  $^{18}\text{F}$ -Labeling procedures developed with the tosylate and nosylate precursors (**27** and **28**) to radiosynthesize the new PDE5 radioligand [ $^{18}\text{F}$ ]**7**.

The stability of the radiotracer was investigated by incubation at 40 °C in phosphate-buffered saline (PBS) and pig plasma samples. [ $^{18}\text{F}$ ]**7** proved to be stable in these media, and no defluorination or degradation was observed within 60 min of incubation time.

#### 2.4. In vitro autoradiographic studies of [ $^{18}\text{F}$ ]**7** on porcine brain

To investigate the distribution of binding sites of [ $^{18}\text{F}$ ]**7** in brain, in vitro autoradiographic studies on porcine brain slices were performed. The most dense binding was detected in the fornix (Fx), followed by corpus callosum (CC) and thalamus (Th). Although in human, PDE5 expression was demonstrated in cerebellum (Cb), cortex (Cx), and hippocampus (Hip) [47], only modest levels of binding were observed for [ $^{18}\text{F}$ ]**7** on these structures of the porcine brain.

To investigate the specificity of [ $^{18}\text{F}$ ]**7** binding, blocking studies with co-incubation of 1  $\mu\text{M}$  of **7** or 1  $\mu\text{M}$  of sildenafil were performed (data in Figure 2). Only a slight decrease of [ $^{18}\text{F}$ ]**7** binding in the range of 10-25% for all of the investigated brain regions was observed indicating a high non-specific binding of the radiotracer. This high non-specific binding has also been observed for our previously reported PDE5 radioligand [ $^{18}\text{F}$ ]**ICF24027** and we assumed it could be related to its high lipophilicity (log*D* of 3.9 calculated using ACD/Labs) [29]. However, in comparison to [ $^{18}\text{F}$ ]**ICF24027**, the hydroxyl group of [ $^{18}\text{F}$ ]**7** is non-alkylated resulting in a calculated log*D* value of 1.56. Thus, the high non-specific binding might be caused by other properties. Probably with an  $\text{IC}_{50}$  value of 5.92 nM as a measure of the inhibitory potential,

the actual affinity of [ $^{18}\text{F}$ ]7 is still too low for a specific imaging of PDE5 as recently discussed by P. Cumming [48]. Based on an estimation of  $B_{\text{max}}$  values in certain brain regions, the author proposed the need of ligands with sub-nanomolar affinity to achieve a binding potential suitable for PET imaging.

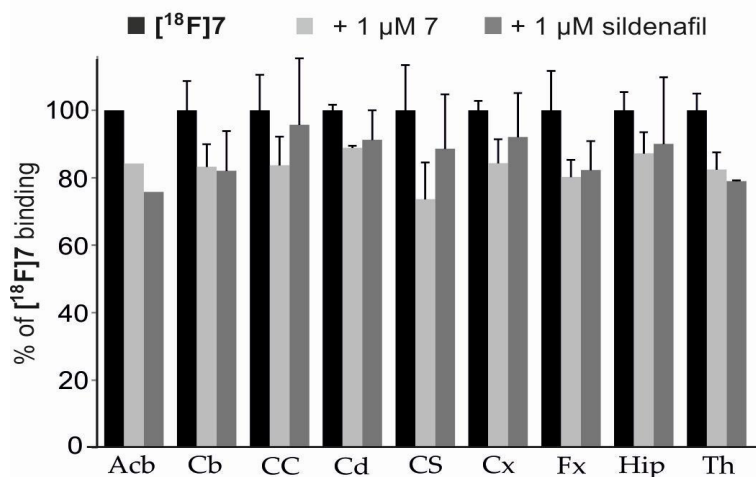

**Figure 2.** Binding of [ $^{18}\text{F}$ ]7 ( $2.02 \pm 0.75$  nM) in porcine brain *in vitro* (n=3). Remaining binding of [ $^{18}\text{F}$ ]7 in the presence of 1  $\mu\text{M}$  7 or 1  $\mu\text{M}$  sildenafil is presented as percentage of total binding (= 100%). Abbreviations: Acb = Nucleus accumbens, Cb = Cerebellum, CC = Corpus callosum, Cd = Nucleus caudatus, CS = Colliculus superior, Cx = Cortex, Fx = Fornix, Hip = Hippocampus, Th = Thalamus.

## 2.5 In vivo studies of [ $^{18}\text{F}$ ]7 in mouse

### 2.5.1. Organ uptake

For mouse brain, we determined standard uptake values (SUV) of 1.10 (n=1) and 0.08 (n=2; single values: 0.10 and 0.05) at 5 and 30 min, respectively, after injection of [ $^{18}\text{F}$ ]7, which indicate perfusion-mediated uptake of the radioligand in the brain followed by a relatively fast washout of the activity. In periphery, we could detect the high initial uptake in organs with comparatively high expression of PDE5 such as lung (SUV = 8.70 and 0.98 at 5 and 30 min p.i.) and heart (SUV = 5.00 and 0.48 at 5 and 30 min p.i.) [49]. Although it might be assumed that the herein observed order of late-stage SUV with lung > heart > brain (0.98, 0.48, 0.08 at 30 min p.i.) in CD1 mouse indeed correlates with the reported mRNA levels in rabbit [49], this assumption remains to be investigated.



### 2.5.2. Metabolism studies

In vivo metabolism of [ $^{18}\text{F}$ ]7 was studied in CD-1 mice ( $n = 2$ ) by investigation of plasma and brain samples obtained from at 30 min after injection of the radioligand. Analysis of the samples was performed by the use of micellar chromatography (MLC) and RP-HPLC. MLC allows the direct injection of samples into the HPLC system without eliminating the tissue matrix due to the ability of micellar aggregates to dissolve the proteins and other components. For RP-HPLC analysis proteins were precipitated by treating aliquots of plasma and brain homogenates with a mixture of acetone/water, resulting in recoveries of about 97% of activity in the supernatants.

The results obtained with both methods correlated very well. According to the chromatograms (Figure 3), a high fraction of radiometabolites was detected in plasma with only 13% of total radioactivity representing the nonmetabolized radioligand [ $^{18}\text{F}$ ]7. Several radioactive metabolites were observed and we assume that some of them are brain penetrable as they were also observed in the corresponding brain samples. Thus, only 24% of total activity was represented by intact [ $^{18}\text{F}$ ]7 in brain (Figure 3). In particular, the more lipophilic radiometabolite [ $^{18}\text{F}$ ]M4 seems to easily penetrate the blood-brain barrier and accumulates in the brain. By contrast, the metabolites group [ $^{18}\text{F}$ ]M1 is very polar as the species are eluting without significant retention on the hydrophobic HPLC column. Despite this polarity, they were also detected in the brain samples to a considerable amount (Figure 3). We assume that this group of radiometabolites consists of small molecular weight species containing alcohol, aldehyde or acid functions which might be formed due to *N*-dealkylation of the azetidinium ring. However, as the radioligand described herein doesn't show the potential for future use, we didn't characterize the structure of the radiometabolites.

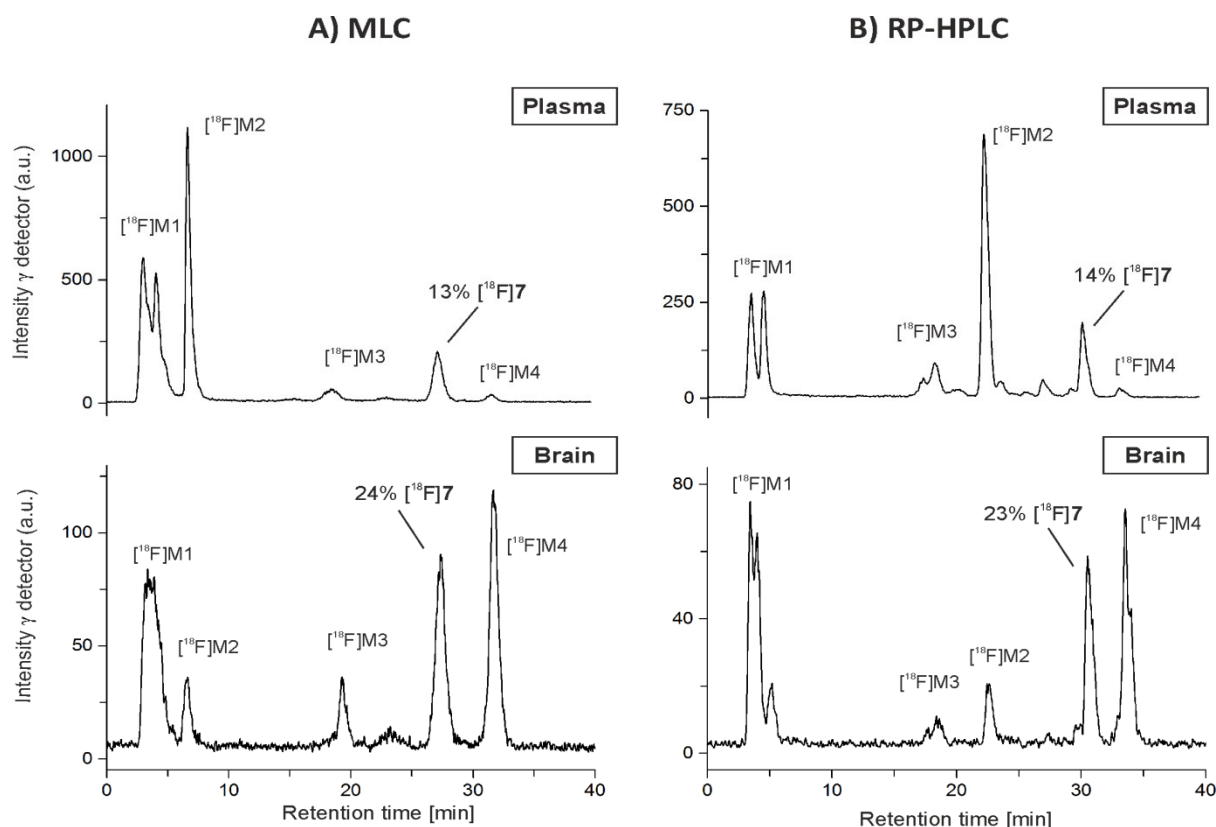

**Figure 3.** Exemplary MLC (A) and RP-HPLC (B) radio-chromatograms of a mouse plasma and brain sample at 30 minutes p.i. of  $[^{18}\text{F}]\mathbf{7}$  (conditions MLC: Reprosil-Pur C18-AQ, 250 x 4.6 mm, gradient with an eluent mixture of THF/100 mM SDS/10 mM  $\text{Na}_2\text{HPO}_4$  aq., 1.0 mL/min; conditions RP-HPLC: Reprosil-Pur C18-AQ, 250 x 4.6 mm, gradient with an eluent mixture of ACN/20 mM  $\text{NH}_4\text{OAc}$  aq., 1.0 mL/min)

### 3. Summary and conclusion

Continuing our efforts in the development of PET imaging probes for characterization of the expression pattern of the cyclic nucleotide phosphodiesterase PDE5 in brain, we synthesized a series of fluorinated derivatives based on a quinoline lead compound (**1**). While structural modification in the "east and west regions" of **1** have been already investigated by our group [28], the present study was dedicated to modifications in the "north and south regions" of **1**. Substitution of a 2-fluoro-3-methoxypyridine ring in the "north part" of **1** caused a loss of inhibitory potential on PDE5. By contrast, the "south part" of **1** is less restricted for structural modifications resulting in the potential 3-fluoroazetidine containing derivative **7** with an  $\text{IC}_{50}$  value of 5.92 nM for PDE5 and high selectivity regarding other PDEs.

As  $^{18}\text{F}$ -labeling of a secondary carbon is challenging, two different leaving groups were investigated for a nucleophilic aliphatic substitution with  $[^{18}\text{F}]\text{fluoride}$ . Interestingly, highest RCY of  $4.9 \pm 1.5\%$  (EOS) was achieved for automated radiosynthesis of  $[^{18}\text{F}]\mathbf{7}$  due to the

addition of small amounts of water to the reaction mixture of the nosylate precursor in 3-methyl-3-pentanol and [ $^{18}\text{F}$ ]TBAF. By contrast, using the tosylate precursor and  $\text{K}[^{18}\text{F}]\text{F}/\text{K}_{222}$  complex in DMSO resulted in lower RCY of  $2.5 \pm 0.1\%$  (EOS). First in vivo studies of [ $^{18}\text{F}$ ]7 in mice indicated perfusion-mediated uptake of the radioligand in the brain followed by a relatively fast washout of activity. However, investigating the in vivo metabolism of [ $^{18}\text{F}$ ]7 in mice disclosed the fast formation of several radiometabolites of which a considerable amount has been also detected in the brain. Moreover, in vitro autoradiographic studies in porcine brain revealed a high nonspecific binding of [ $^{18}\text{F}$ ]7 which might be related to insufficient affinity toward PDE5.

In conclusion, the results of this study support the assumption that for PET imaging of the PDE5 enzyme, specific radioligands with an affinity in the sub-nanomolar range seem to be crucial.

## 4. Experimental section

### 4.1 Organic chemistry

#### 4.1.1 General

All commercially available reagents and solvents were purchased from the following commercial suppliers: Sigma Aldrich, Acros Organics, Carlo Erba, and Alfa Aesar and were used without further purification. Room temperature (rt) refers to 20-25 °C. All solvents were dried using common techniques. Air and moisture sensitive reactions were carried out under anhydrous argon atmosphere. Magnesium sulfate ( $\text{MgSO}_4$ ) and sodium sulfate ( $\text{Na}_2\text{SO}_4$ ) were used as drying agents. Monitoring of the reaction progress was performed using thin layer chromatography (TLC) on silica 60 F254 or alumina gel 60A + F254 plates and visualized with UV light (UV lamp Fisher Bioblock Scientific, 365 nm or 254 nm) or with an appropriate staining agent. Column chromatography was performed on silica gel (Chromagel 60 ACC, 40-63  $\mu\text{m}$ , Carlo Erba Reagents) or on alumina gel (Merck, column chromatographic adsorption analysis ACC. to Brockmann, neutral aluminium oxide 90, standardised, 63-200  $\mu\text{m}$ ). Uncorrected melting points (mp) were measured on an IA9100 Digital Melting Point Apparatus. Infrared spectra (IR) were recorded in the range of 4000-600  $\text{cm}^{-1}$  on a Nicolet IS10 with attenuated total reflectance (ATR) accessory (v: stretch, as: asymmetric, s: symmetric,  $\delta$ : deformation; op: out of plane). Nuclear magnetic resonance (NMR) spectra were recorded on a Bruker Avance 500 instrument (500 MHz for  $^1\text{H}$ , 125 MHz for  $^{13}\text{C}$ ), a Bruker Avance 400 instrument (400 MHz for  $^1\text{H}$ , 100 MHz for  $^{13}\text{C}$ ) or a Bruker Avance 200 instrument (200 MHz for  $^1\text{H}$ , 50 MHz for  $^{13}\text{C}$ ). All chemical shifts ( $\delta$ ) are reported in parts per million (ppm). Coupling constants ( $J$ ) are given in Hertz (Hz). Spectral coupling patterns are indicated as follow: s: singlet; d: doublet; t: triplet; q: quartet; m: multiplet, brt: broad triplet and brs: broad singlet. All new compounds were analyzed by HRMS (High-Resolution Mass Spectrometry, Waters® Micromass® Q-ToF micro™

Mass Spectrometer, UCA-START, Clermont-Auvergne University, Clermont-Ferrand, France). The isotope peaks for chlorine and bromine atoms are given with their relative intensities.

#### 4.1.2 Syntheses

##### 4.1.2.1. Ethyl 8-bromo-6-cyano-4-[[[(6-fluoro-5-methoxypyridin-2-yl)methyl]amino]quinoline-3-carboxylate (**12**):

*N,N*-Diisopropylethylamine (293 mg, 2.32 mmol, 4.0 eq.) and the crude product **10a** (550 mg, 2.85 mmol, 5.0 eq., synthesis in supporting information) were added under stirring to a solution of **11** [28] (193 mg, 0.57 mmol, 1.0 eq.) in *n*-propanol (15 mL). The resulting mixture was refluxed for 2 hours. After cooling to rt, water (30 mL) was added. The formed precipitate was collected by filtration, washed with ethanol (10 mL) and dried to give the desired product (160 mg, 0.35 mmol, 61%) as a white solid.  $R_f$  (SiO<sub>2</sub>, cyclohexane/ethyl acetate, 7/3, v/v): 0.15; Mp: 186 ± 1 °C; IR (cm<sup>-1</sup>)  $\nu$  2241 ( $\nu_{C\equiv N}$ ), 1463 ( $\delta_{CH_3}$ ), 1173 ( $\nu_{C-O}$ ); <sup>1</sup>H NMR (400 MHz, DMSO-d<sub>6</sub>)  $\delta$  9.49 (brs, 1H, NH), 8.94 (m, 2H, H<sub>2</sub>, H<sub>5</sub>), 8.49 (d, 1H, <sup>3</sup> $J_{H7-H5}$  = 1.5 Hz, H<sub>7</sub>), 7.65 (dd, 1H, <sup>3</sup> $J_{H5'-H6'}$  = 8.1 Hz, <sup>4</sup> $J_{H5'-F}$  = 10.5 Hz, H<sub>5'</sub>), 7.32 (d, 1H, <sup>3</sup> $J_{H6'-H5'}$  = 8.1 Hz, H<sub>6'</sub>), 4.92 (d, 2H, <sup>3</sup> $J_{Hd-NH}$  = 5.2 Hz, H<sub>d</sub>), 4.30 (q, 2H, <sup>3</sup> $J_{Hb-Hc}$  = 7.1 Hz, H<sub>b</sub>), 3.86 (s, 3H, H<sub>e</sub>), 1.29 (t, 3H, <sup>3</sup> $J_{Hc-Hb}$  = 7.1 Hz, H<sub>c</sub>); <sup>13</sup>C NMR (100 MHz, DMSO-d<sub>6</sub>)  $\delta$  166.7 (C<sub>a</sub>), 153.9 (C<sub>2</sub>), 153.5 (C<sub>4</sub>), 152.0 (d, <sup>1</sup> $J_{C3'-F}$  = 234 Hz, C<sub>3'</sub>), 148.5 (C<sub>8a</sub>), 143.8 (d, <sup>3</sup> $J_{C1'-F}$  = 11 Hz, C<sub>1'</sub>), 141.5 (d, <sup>2</sup> $J_{C4'-F}$  = 25 Hz, C<sub>4'</sub>), 135.1 (C<sub>7</sub>), 131.7 (C<sub>5</sub>), 125.3 (C<sub>8</sub>), 123.7 (d, <sup>3</sup> $J_{C5'-F}$  = 3 Hz, C<sub>5'</sub>), 120.9 (d, <sup>4</sup> $J_{C6'-F}$  = 4 Hz, C<sub>6'</sub>), 119.8 (C<sub>4a</sub>), 117.8 (CN), 107.3 (C<sub>6</sub>), 105.4 (C<sub>3</sub>), 61.2 (C<sub>b</sub>), 56.3 (C<sub>e</sub>), 50.4 (C<sub>d</sub>), 14.0 (C<sub>c</sub>); HRMS (ESI)  $m/z$  calculated for C<sub>20</sub>H<sub>17</sub><sup>79</sup>BrFN<sub>4</sub>O<sub>3</sub> [M+H]<sup>+</sup>: 459.0468, found C<sub>20</sub>H<sub>17</sub><sup>79</sup>BrFN<sub>4</sub>O<sub>3</sub> [M+H]<sup>+</sup>: 459.0474 (100%); C<sub>20</sub>H<sub>17</sub><sup>81</sup>BrFN<sub>4</sub>O<sub>3</sub> [M+H]<sup>+</sup>: 461.0457 (98%).

##### 4.1.2.2. General procedure for **13a** and **13b**:

Under stirring and argon atmosphere, cyclopropylboronic acid (3.0 eq.) or ethylboronic acid (16 eq.), tetrakis(triphenylphosphine)palladium(0) (15 mg, 12.9  $\mu$ mol, 0.06 eq.) and caesium carbonate (2.5 eq.) were added to a solution of **12** (1.0 eq.) in anhydrous toluene (10 mL). The resulting mixture was refluxed until the TLC monitoring revealed the complete consumption of **12** (15 h for **13a** and 22 h for **13b**). After cooling to room temperature, the solvent was evaporated under reduced pressure. The crude product was purified by column chromatography to give **13a** or **13b** as white solid.

##### 4.1.2.2.1. Ethyl 6-cyano-8-ethyl-4-[[[(6-fluoro-5-methoxypyridin-2-yl)methyl]amino]quinoline-3-carboxylate (**13a**):

Column chromatography conditions: SiO<sub>2</sub>, ethyl acetate/cyclohexane, 5/5, v/v; yield: 68% (60 mg, 0.15 mmol);  $R_f$  (SiO<sub>2</sub>, cyclohexane/ethyl acetate, 6/4, v/v): 0.65; Mp: 152 ± 1 °C; IR (cm<sup>-1</sup>)  $\nu$  2229 ( $\nu_{C\equiv N}$ ), 1687 ( $\nu_{C=O}$ ), 1570 ( $\delta_{N-H}$ ), 1358 ( $\delta_{CH_3}$ ), 1283 ( $\nu_{C-O}$ ), 1187 ( $\nu_{C-O}$ ); <sup>1</sup>H NMR (400 MHz, CDCl<sub>3</sub>)  $\delta$  9.80 (brs, 1H, NH), 9.21 (s, 1H, H<sub>2</sub>), 8.39 (d, 1H, <sup>4</sup> $J_{H5-H7}$  = 1.7 Hz, H<sub>5</sub>), 7.64 (d, 1H, <sup>4</sup> $J_{H7-H5}$  = 1.7 Hz, H<sub>7</sub>), 7.31 (dd, 1H, <sup>3</sup> $J_{H5'-H6'}$  = 8.0 Hz, <sup>3</sup> $J_{H5'-HF}$  = 9.8 Hz, H<sub>5'</sub>), 7.23 (d, 1H, <sup>3</sup> $J_{H6'-H5'}$  = 8.0 Hz, H<sub>6'</sub>), 4.92 (d, 2H, <sup>3</sup> $J_{Hd-NH}$  = 5.5 Hz, H<sub>d</sub>), 4.39 (q, 2H, <sup>3</sup> $J_{Hb-Hc}$  = 7.1 Hz, H<sub>b</sub>), 3.91 (s, 3H, H<sub>e</sub>), 3.19 (q,

2H,  $^3J_{\text{Hf-Hg}} = 7.5$  Hz, Hf), 1.40 (t, 3H,  $^3J_{\text{Hc-Hb}} = 7.1$  Hz, Hc), 1.32 (t, 3H,  $^3J_{\text{Hg-Hf}} = 7.5$  Hz, Hg);  $^{13}\text{C}$  NMR (100 MHz,  $\text{CDCl}_3$ )  $\delta$  168.0 (C<sub>a</sub>), 156.6 (C<sub>4</sub>), 154.1 (d,  $^1J_{\text{C3'-F}} = 241$  Hz, C<sub>3'</sub>), 152.6 (C<sub>2</sub>), 151.0 (C<sub>8a</sub>), 144.9 (C<sub>8</sub>), 144.1 (d,  $^3J_{\text{C1'-F}} = 11$  Hz, C<sub>1'</sub>), 142.4 (d,  $^2J_{\text{C4'-F}} = 25$  Hz, C<sub>4'</sub>), 130.1 (C<sub>7</sub>), 129.7 (C<sub>5</sub>), 122.3 (d,  $^3J_{\text{C5'-F}} = 4$  Hz, C<sub>5'</sub>), 119.4 (d,  $^4J_{\text{C6'-F}} = 4$  Hz, C<sub>6'</sub>), 119.1 (CN), 118.7 (C<sub>4a</sub>), 107.0 (C<sub>6</sub>), 104.8 (C<sub>3</sub>), 61.1 (C<sub>b</sub>), 56.3 (C<sub>e</sub>), 52.5 (C<sub>d</sub>), 24.9 (C<sub>f</sub>), 14.3 (C<sub>g</sub>), 14.1 (C<sub>c</sub>); HRMS (ESI)  $m/z$  calculated for  $\text{C}_{22}\text{H}_{22}\text{FN}_4\text{O}_3$   $[\text{M}+\text{H}]^+$ : 409.1676, found 409.1657.

#### 4.1.2.2. Ethyl 6-cyano-8-cyclopropyl-4-[[[(6-fluoro-5-methoxypyridin-2-yl)methyl]amino]quinoline-3-carboxylate (**13b**):

Column chromatography conditions:  $\text{SiO}_2$ , ethyl acetate/cyclohexane, 4/6, v/v; yield: 86% (80 mg, 0.19 mmol);  $R_f$  ( $\text{Al}_2\text{O}_3$ , cyclohexane/ ethyl acetate, 5/5, v/v): 0.74; Mp:  $155 \pm 1$  °C; IR ( $\text{cm}^{-1}$ )  $\nu$  2226 ( $\nu_{\text{C}\equiv\text{N}}$ ), 1667 ( $\nu_{\text{C}=\text{O}}$ ), 1473 ( $\delta_{\text{CH}_3}$ ), 1198 ( $\nu_{\text{C-O}}$ );  $^1\text{H}$  NMR (400 MHz,  $\text{CDCl}_3$ )  $\delta$  9.98 (brs, 1H, NH), 9.27 (s, 1H, H<sub>2</sub>), 8.36 (d, 1H,  $^4J_{\text{H5-H7}} = 1.4$  Hz, H<sub>5</sub>), 7.29 (m, 2H, H<sub>7</sub>, H<sub>5'</sub>), 7.22 (d, 1H,  $^3J_{\text{H6'-H5'}} = 8.1$  Hz, H<sub>6'</sub>), 4.93 (d, 2H,  $^3J_{\text{Hd-NH}} = 5.5$  Hz, H<sub>d</sub>), 4.40 (q, 2H,  $^3J_{\text{Hb-Hc}} = 7.1$  Hz, H<sub>b</sub>), 3.91 (s, 3H, H<sub>e</sub>), 3.04 (m, 1H, H<sub>f</sub>), 1.39 (t, 3H,  $^3J_{\text{Hc-Hb}} = 7.1$  Hz, H<sub>b</sub>), 1.23 (m, 2H, H<sub>g</sub> or H<sub>g'</sub>), 0.79 (m, 2H, H<sub>g</sub> or H<sub>g'</sub>);  $^{13}\text{C}$  NMR (100 MHz,  $\text{CDCl}_3$ )  $\delta$  167.7 (C<sub>a</sub>), 156.8 (C<sub>4</sub>), 153.1 (d,  $^1J_{\text{C3'-F}} = 241$  Hz, C<sub>3'</sub>), 152.1 (C<sub>2</sub>), 144.3 (C<sub>8a</sub>), 143.7 (2C, C<sub>8</sub>, C<sub>1'</sub>), 142.5 (d,  $^2J_{\text{C4'-F}} = 25$  Hz, C<sub>4'</sub>), 128.8 (C<sub>5</sub>), 126.4 (C<sub>7</sub>), 122.3 (d,  $^3J_{\text{C5'-F}} = 4$  Hz, C<sub>5'</sub>), 119.4 (d,  $^3J_{\text{C6'-F}} = 4$  Hz, C<sub>6'</sub>), 118.9 (CN or C<sub>4a</sub>), 118.5 (CN or C<sub>4a</sub>), 107.4 (C<sub>6</sub>), 104.8 (C<sub>3</sub>), 61.3 (C<sub>b</sub>), 56.3 (C<sub>e</sub>), 52.4 (C<sub>d</sub>), 14.1 (C<sub>c</sub>), 11.3 (C<sub>f</sub>), 9.7 (2C, C<sub>g</sub>, C<sub>g'</sub>); HRMS (ESI)  $m/z$  calculated for  $\text{C}_{23}\text{H}_{22}\text{FN}_4\text{O}_3$   $[\text{M}+\text{H}]^+$ : 421.1676, found 421.1688.

#### 4.1.2.3. General procedure for **3** and **4**:

A 1.1 M solution of lithium tri-*tert*-butoxyaluminum hydride in anhydrous tetrahydrofuran (2.7 mL, 2.97 mmol, 6.0 eq.) was added to a solution of **13a** or **13b** (1.0 eq.) in anhydrous tetrahydrofuran (15 mL) under stirring and argon atmosphere. The resulting mixture was heated at 50 °C for 30 hours. After cooling to room temperature, an 0.1 M aqueous sodium hydroxide solution (40 mL) was slowly added under stirring (pH 10-11). The aqueous layer was extracted with ethyl acetate (4 x 40 mL). The combined organic layers were washed with brine (60 mL), dried over anhydrous magnesium sulfate, filtered and then concentrated under reduced pressure. The crude product was purified by chromatography ( $\text{SiO}_2$ , ethanol/dichloromethane, 1/9, v/v) to give the desired products **3** (white solid) or **4** (light yellow solid).

##### 4.1.2.3.1. 8-Ethyl-4-[[[(6-fluoro-5-methoxypyridin-2-yl)methyl]amino]-3-(hydroxymethyl)quinoline-6-carbonitrile (**3**):

Yield: 36% (65 mg, 0.18 mmol);  $R_f$  ( $\text{SiO}_2$ , ethanol/dichloromethane, 1/9, v/v): 0.29; Mp:  $168 \pm 1$  °C; IR ( $\text{cm}^{-1}$ )  $\nu$  3420 ( $\nu_{\text{N-H}}$ ), 2228 ( $\nu_{\text{C}\equiv\text{N}}$ ), 1563 ( $\delta_{\text{N-H}}$ ), 1479 ( $\delta_{\text{CH}_3}$ ), 1010 ( $\nu_{\text{C-O}}$ );  $^1\text{H}$  NMR (400 MHz,  $\text{DMSO-d}_6$ )  $\delta$  8.81 (d, 1H,  $^4J_{\text{H5-H7}} = 1.5$  Hz, H<sub>5</sub>), 8.48 (s, 1H, H<sub>2</sub>), 7.75 (d, 1H,  $^4J_{\text{H7-H5}} = 1.5$  Hz, H<sub>7</sub>), 7.59 (dd, 1H,  $^3J_{\text{H5'-H6'}} = 8.1$  Hz,  $^4J_{\text{H5'-F}} = 10.6$  Hz, H<sub>5'</sub>), 7.53 (t, 1H,  $^3J_{\text{NH-Hb}} = 6.7$  Hz, NH), 7.21 (d, 1H,  $^3J_{\text{H6'-H5'}} = 8.1$  Hz, H<sub>6'</sub>), 5.36 (t, 1H,  $^3J_{\text{OH-Ha}} = 5.1$  Hz, OH), 4.84 (d, 2H,  $^3J_{\text{Hb-NH}} = 6.7$  Hz, H<sub>b</sub>), 4.47 (d, 2H,  $^3J_{\text{Ha-OH}} = 5.1$  Hz, H<sub>a</sub>), 3.83 (s, 3H, H<sub>c</sub>), 3.13 (q, 2H,  $^3J_{\text{Hd-He}} = 7.5$  Hz, H<sub>d</sub>), 1.25 (t, 3H,  $^3J_{\text{He-Hd}} = 7.5$  Hz, H<sub>e</sub>);  $^{13}\text{C}$  NMR (100 MHz,  $\text{DMSO-d}_6$ )  $\delta$  155.2 (C<sub>2</sub>), 151.9 (d,  $^1J_{\text{C3'-F}} = 236$  Hz, C<sub>3'</sub>), 149.9 (C<sub>4</sub>), 148.1 (C<sub>8a</sub>), 147.5 (d,  $^3J_{\text{C1'-F}} = 11$  Hz, C<sub>1'</sub>), 144.1 (C<sub>8</sub>), 140.9 (d,  $^2J_{\text{C4'-F}} = 25$  Hz, C<sub>4'</sub>), 127.6 (C<sub>7</sub>),

127.4 (C<sub>5</sub>), 123.6 (d, <sup>3</sup>J<sub>C5'-F</sub> = 4 Hz, C<sub>5'</sub>), 119.6 (2C, CN, C<sub>4a</sub>), 119.2 (d, <sup>4</sup>J<sub>C6'-F</sub> = 4 Hz, C<sub>6'</sub>), 115.5 (C<sub>3</sub>), 106.1 (C<sub>6</sub>), 59.7 (C<sub>a</sub>), 56.2 (C<sub>c</sub>), 48.8 (C<sub>b</sub>), 24.2 (C<sub>d</sub>), 14.8 (C<sub>e</sub>); HRMS (ESI) *m/z* calculated for C<sub>20</sub>H<sub>20</sub>FN<sub>4</sub>O<sub>2</sub> [M+H]<sup>+</sup>: 367.1570; found 367.1528.

#### 4.1.2.3.2. 8-Cyclopropyl-4-(((6-fluoro-5-methoxypyridin-2-yl)methyl)amino)-3-(hydroxymethyl)quinoline-6-carbonitrile (4):

Yield: 45% (120 mg, 0.32 mmol); R<sub>f</sub> (SiO<sub>2</sub>, ethanol/dichloromethane, 1/9, v/v): 0.40; Mp: 183 ± 1 °C; IR (cm<sup>-1</sup>) ν 2226 (ν<sub>C≡N</sub>), 1542 (δ<sub>N-H</sub>), 1478 (δ<sub>CH<sub>3</sub></sub>), 1260 (ν<sub>C-O</sub>), 1036 (ν<sub>C-O</sub>); <sup>1</sup>H NMR (400 MHz, DMSO-d<sub>6</sub>) δ 8.73 (d, 1H, <sup>4</sup>J<sub>H5-H7</sub> = 1.4 Hz, H<sub>5</sub>), 8.51 (s, 1H, H<sub>2</sub>), 7.58 (dd, 1H, <sup>3</sup>J<sub>H5'-H6'</sub> = 8.2 Hz, <sup>4</sup>J<sub>H5'-F</sub> = 10.5 Hz, H<sub>5'</sub>), 7.50 (t, 1H, <sup>3</sup>J<sub>NH-Hb</sub> = 6.6 Hz, NH), 7.35 (d, 1H, <sup>4</sup>J<sub>H7-H5</sub> = 1.4 Hz, H<sub>7</sub>), 7.21 (d, 1H, <sup>3</sup>J<sub>H6'-H5'</sub> = 8.2 Hz, H<sub>6'</sub>), 5.39 (t, 1H, <sup>3</sup>J<sub>OH-Ha</sub> = 5.1 Hz, OH), 4.84 (d, 2H, <sup>3</sup>J<sub>Hb-NH</sub> = 6.6 Hz, H<sub>b</sub>), 4.49 (d, 2H, <sup>3</sup>J<sub>Ha-OH</sub> = 5.1 Hz, H<sub>a</sub>), 3.83 (s, 3H, H<sub>c</sub>), 3.13 (m, 1H, H<sub>d</sub>), 1.11 (m, 2H, H<sub>e</sub> or H<sub>e'</sub>), 0.85 (m, 2H, H<sub>e</sub> or H<sub>e'</sub>); <sup>13</sup>C NMR (100 MHz, DMSO-d<sub>6</sub>) δ 155.1 (C<sub>2</sub>), 151.9 (d, <sup>1</sup>J<sub>C3'-F</sub> = 236 Hz, C<sub>3'</sub>), 149.9 (C<sub>4</sub>), 148.7 (C<sub>8a</sub>), 147.5 (d, <sup>3</sup>J<sub>C1'-F</sub> = 11 Hz, C<sub>1'</sub>), 144.4 (C<sub>8</sub>), 140.9 (d, <sup>2</sup>J<sub>C4'-F</sub> = 25 Hz, C<sub>4'</sub>), 126.2 (C<sub>5</sub>), 123.5 (d, <sup>3</sup>J<sub>C5'-F</sub> = 4 Hz, C<sub>5'</sub>), 122.5 (C<sub>7</sub>), 119.6 (CN), 119.5 (C<sub>3</sub>), 119.2 (d, <sup>4</sup>J<sub>C6'-F</sub> = 3 Hz, C<sub>6'</sub>), 115.7 (C<sub>4a</sub>), 106.4 (C<sub>6</sub>), 59.7 (C<sub>a</sub>), 56.1 (C<sub>c</sub>), 48.9 (C<sub>b</sub>), 10.6 (C<sub>d</sub>), 10.1 (2C, C<sub>e</sub>, C<sub>e'</sub>); HRMS (ESI) *m/z* calculated for C<sub>21</sub>H<sub>20</sub>FN<sub>4</sub>O<sub>2</sub> [M+H]<sup>+</sup>: 379.1570, found 379.1535.

#### 4.1.2.4. Ethyl 4-[(3-chloro-4-methoxybenzyl)amino]-6-cyano-8-(3-hydroxypropyl)quinoline-3-carboxylate (15):

A solution of 0.5 M 9-borabicyclo[3.3.1]nonane (9-BBN) in anhydrous tetrahydrofuran (25 mL, 12.5 mmol, 6.0 eq.) was slowly added at 0 °C and under argon atmosphere to a solution of allyl alcohol (0.86 mL, 12.6 mmol, 6.0 eq.) in anhydrous and previously degassed tetrahydrofuran (3.0 mL). The resulting mixture was stirred at rt for 7 hours. This solution was then added, under argon atmosphere, to a mixture of **14** [28] (1.0 g, 2.11 mmol, 1.0 eq.), tetrakis(triphenylphosphine)palladium(0) (0.24 g, 0.21 mmol, 0.1 eq.), potassium carbonate (1.16 g, 8.39 mmol, 4.0 eq.), and water (1.0 mL) in anhydrous *N,N*-dimethylformamide (40 mL). The resulting mixture was stirred at 80 °C for 22 hours. After cooling to room temperature, water (40 mL) was added and the aqueous layer was extracted with ethyl acetate (3 × 50 mL). The combined organic layers were washed with brine (3 × 100 mL), dried with anhydrous magnesium sulfate, filtered and concentrated under reduced pressure. The crude residue was purified by column chromatography (SiO<sub>2</sub>, ethyl acetate/cyclohexane, 5/5, v/v) to give by order of elution the desired product **15** (0.25 g, 0.55 mmol, 26%) as a yellow solid, and ethyl 4-[(3-chloro-4-methoxybenzyl)amino]-6-cyanoquinoline-3-carboxylate (0.24 g, 0.61 mmol, 29%). R<sub>f</sub> (SiO<sub>2</sub>, cyclohexane/ethyl acetate, 5/5, v/v): 0.17; Mp: 118 ± 1 °C; IR (cm<sup>-1</sup>) ν 2231 (ν<sub>C≡N</sub>), 1673 (ν<sub>C=O</sub>), 1595 (ν<sub>C=C</sub>), 1505 (δ<sub>N-H</sub>), 1262 (ν<sub>C-O</sub>), 1190 (ν<sub>C-O</sub>), 1068 (ν<sub>C-O</sub>); <sup>1</sup>H NMR (400 MHz, CDCl<sub>3</sub>) δ 9.80 (brt, 1H, NH), 9.18 (s, 1H, H<sub>2</sub>), 8.40 (d, 1H, <sup>4</sup>J<sub>H5-H7</sub> = 1.7 Hz, H<sub>5</sub>), 7.70 (d, <sup>4</sup>J<sub>H7-H5</sub> = 1.7 Hz, H<sub>7</sub>), 7.39 (d, 1H, <sup>4</sup>J<sub>H2'-H6'</sub> = 2.2 Hz, H<sub>2'</sub>), 7.26 (dd, 1H, <sup>3</sup>J<sub>H6'-H5'</sub> = 8.4 Hz, <sup>4</sup>J<sub>H6'-H2'</sub> = 2.2 Hz, H<sub>6'</sub>), 6.97 (d, 1H, <sup>3</sup>J<sub>H5'-H6'</sub> = 8.4 Hz, H<sub>5'</sub>), 4.88 (d, 2H, <sup>3</sup>J<sub>Hd-NH</sub> = 5.5 Hz, H<sub>d</sub>), 4.36 (q, 2H, <sup>3</sup>J<sub>Hb-Hc</sub> = 7.1 Hz, H<sub>b</sub>), 3.91 (s, 3H, H<sub>e</sub>), 3.39 (m, 2H, H<sub>h</sub>), 3.29 (m, 2H, H<sub>f</sub>), 1.94 (m, 2H, H<sub>g</sub>), 1.40 (t, 3H, <sup>3</sup>J<sub>Hc-Hb</sub> = 7.1 Hz, H<sub>c</sub>); <sup>13</sup>C NMR (100 MHz, CDCl<sub>3</sub>) δ 168.2 (C<sub>a</sub>), 156.8 (C<sub>4</sub>), 155.1 (C<sub>4'</sub>), 153.0 (C<sub>2</sub>), 151.5 (C<sub>8a</sub>), 142.8 (C<sub>8</sub>), 132.7 (C<sub>7</sub>), 130.5 (C<sub>5</sub>), 130.2 (C<sub>1'</sub>), 129.4 (C<sub>2'</sub>), 126.9 (C<sub>6'</sub>), 123.5 (C<sub>3'</sub>), 118.8 (CN), 118.6

(C<sub>4a</sub>), 112.6 (C<sub>5'</sub>), 107.4 (C<sub>6</sub>), 104.3 (C<sub>3</sub>), 61.5 (C<sub>b</sub>), 59.5 (C<sub>h</sub>), 56.3 (C<sub>e</sub>), 52.0 (C<sub>d</sub>), 33.9 (C<sub>g</sub>), 27.0 (C<sub>f</sub>), 14.3 (C<sub>c</sub>); HRMS (ESI) *m/z* calculated for C<sub>24</sub>H<sub>25</sub><sup>35</sup>ClN<sub>3</sub>O<sub>4</sub> [M+H]<sup>+</sup>: 454.1534, found C<sub>24</sub>H<sub>25</sub><sup>35</sup>ClN<sub>3</sub>O<sub>4</sub> [M+H]<sup>+</sup>: 454.1559 (100%); C<sub>24</sub>H<sub>25</sub><sup>37</sup>ClN<sub>3</sub>O<sub>4</sub> [M+H]<sup>+</sup>: 456.1554 (33%).

#### 4.1.2.5. Ethyl 1-[(3-chloro-4-methoxybenzyl)imino]-9-cyano-6,7-dihydro-1H,5H-pyrido[3,2,1-ij]quinoline-2-carboxylate (**17**):

Diethylaminosulfur trifluoride (DAST, 41  $\mu$ L, 0.31 mmol, 2.0 eq.) was added dropwise, at -60 °C and under stirring, to a solution of **15** (70 mg, 0.15 mmol, 1.0 eq.) in anhydrous dichloromethane (5.0 mL). The temperature was slowly increased to -30 °C and the mixture was stirred between -30 °C and -20 °C for 2 hours before addition of an aqueous saturated sodium bicarbonate solution (10 mL) at -20 °C (pH = 7-8). This mixture was extracted with dichloromethane (2  $\times$  15 mL). The combined organic layers were washed with brine (50 mL), dried over anhydrous magnesium sulfate, filtered and evaporated under reduced pressure. The residue was purified by column chromatography (Al<sub>2</sub>O<sub>3</sub>, ethyl acetate/cyclohexane, 7/3, v/v) to give **17** (30 mg, 84.8  $\mu$ mol, 57%) as a yellow solid. R<sub>f</sub> (SiO<sub>2</sub>, cyclohexane/ethyl acetate, 3/7, v/v): 0.25; Mp: 152  $\pm$  1 °C; IR (cm<sup>-1</sup>)  $\nu$  2224 ( $\nu_{C\equiv N}$ ), 1702 ( $\nu_{C=O}$ ), 1574 ( $\nu_{C=N}$ ), 1502 ( $\nu_{C=C}$ ), 1271 ( $\nu_{C-O}$ ), 1170 ( $\nu_{C-O}$ ), 1062 ( $\nu_{C-O}$ ); <sup>1</sup>H NMR (400 MHz, CDCl<sub>3</sub>)  $\delta$  8.53 (s, 1H, H<sub>5</sub>), 7.73 (s, 1H, H<sub>2</sub>), 7.38 (m, 2H, H<sub>2'</sub>, H<sub>7</sub>), 7.29 (dd, 1H, <sup>3</sup>J<sub>H6'-H5'</sub> = 8.4 Hz, <sup>4</sup>J<sub>H6'-H2'</sub> = 2.1 Hz, H<sub>6'</sub>), 6.90 (d, 1H, <sup>3</sup>J<sub>H5'-H6'</sub> = 8.4 Hz, H<sub>5'</sub>), 4.33 (s, 2H, H<sub>d</sub>), 4.31 (q, 2H, <sup>3</sup>J<sub>Hb-Hc</sub> = 7.1 Hz, H<sub>b</sub>), 3.96 (m, 2H, H<sub>h</sub>), 3.88 (s, 3H, H<sub>e</sub>), 2.95 (m, 2H, H<sub>f</sub>), 2.14 (m, 2H, H<sub>g</sub>), 1.35 (t, 3H, <sup>3</sup>J<sub>Hc-Hb</sub> = 7.1 Hz, H<sub>c</sub>); <sup>13</sup>C NMR (100 MHz, CDCl<sub>3</sub>)  $\delta$  166.3 (C<sub>a</sub>), 153.6 (C<sub>4'</sub>), 149.2 (C<sub>4</sub>), 145.4 (C<sub>2</sub>), 137.5 (C<sub>8a</sub>), 135.7 (C<sub>1'</sub>), 131.8 (C<sub>7</sub>), 129.7 (C<sub>5</sub>), 129.6 (C<sub>2'</sub>), 129.1 (C<sub>8</sub>), 127.1 (C<sub>6'</sub>), 126.4 (C<sub>4a</sub>), 122.2 (C<sub>3'</sub>), 119.0 (CN), 122.1 (C<sub>5'</sub>), 107.5 (C<sub>6</sub>), 106.0 (C<sub>3</sub>), 61.1 (C<sub>b</sub>), 56.4 (C<sub>e</sub>), 55.5 (C<sub>d</sub>), 51.7 (C<sub>h</sub>), 26.8 (C<sub>f</sub>), 20.9 (C<sub>g</sub>), 14.5 (C<sub>c</sub>); HRMS (ESI) *m/z* calculated for C<sub>24</sub>H<sub>23</sub><sup>35</sup>ClN<sub>3</sub>O<sub>3</sub> [M+H]<sup>+</sup>: 436.1428, found C<sub>24</sub>H<sub>23</sub><sup>35</sup>ClN<sub>3</sub>O<sub>3</sub> [M+H]<sup>+</sup>: 436.1423 (100%); C<sub>24</sub>H<sub>23</sub><sup>37</sup>ClN<sub>3</sub>O<sub>3</sub> [M+H]<sup>+</sup>: 438.1433 (33%).

#### 4.1.2.6. Ethyl 8-bromo-4-[(*tert*-butoxycarbonyl)(3-chloro-4-methoxybenzyl)amino]-6-cyanoquinoline-3-carboxylate (**18**):

Di-*tert*-butyl dicarbonate (0.92 g, 4.22 mmol, 2.0 eq.), triethylamine (59  $\mu$ L, 4.22 mmol, 2.0 eq.) and *N,N*-4-dimethylaminopyridine (51 mg, 0.42 mmol, 0.2 eq.) were added under argon to a solution of **14** [28] (1.0 g, 2.11 mmol, 1.0 eq.) in anhydrous tetrahydrofuran (40 mL). The resulting mixture was stirred at rt for 2.5 hours before addition of water (40 mL). The aqueous layer was extracted with dichloromethane (3  $\times$  50 mL). The combined organic layers were washed with brine (100 mL), dried over magnesium sulfate, filtered and concentrated under reduced pressure. The crude residue was purified by column chromatography (SiO<sub>2</sub>, ethyl acetate/cyclohexane, 3/7, v/v) to give the desired product (0.90 g, 1.57 mmol, 74%) as a white solid. R<sub>f</sub> (SiO<sub>2</sub>, ethyl acetate/cyclohexane, 3/7, v/v): 0.48; mp: 139  $\pm$  1 °C; IR (cm<sup>-1</sup>)  $\nu$  2234 ( $\nu_{C\equiv N}$ ), 1708 ( $\nu_{C=O}$ ), 1366 ( $\delta_{CH_3}$ ), 1255 ( $\nu_{C-O}$ ), 1151 ( $\nu_{C-O}$ ); Analyses of NMR spectra revealed that this product was a mixture of two rotamers, named A and B with a ratio A/B = 1/0.3; <sup>1</sup>H NMR (400 MHz, CDCl<sub>3</sub>)  $\delta$  9.41 (s, 1H, H<sub>2(B)</sub>), 9.40 (s, 1H, H<sub>2(A)</sub>), 8.03 (d, 1H, <sup>4</sup>J<sub>H5(A)-H7(A)}</sub> = 1.7 Hz, H<sub>5(A)</sub>), 8.02 (d, 1H, <sup>4</sup>J<sub>H5(B)-H7(B)}</sub> = 1.6 Hz, H<sub>5(B)</sub>), 7.77 (d, 1H, <sup>4</sup>J<sub>H7(B)-H5(B)}</sub> = 1.6 Hz, H<sub>7(B)</sub>), 7.75 (d, 1H, <sup>4</sup>J<sub>H7(A)-H5(A)}</sub>

= 1.7 Hz, H<sub>7(A)</sub>), 6.98 (d, 1H, <sup>4</sup>J<sub>H2'(B)-H6'(B)</sub> = 1.9 Hz, H<sub>2'(B)</sub>), 6.91 (d, 1H, <sup>4</sup>J<sub>H2'(A)-H6'(A)</sub> = 2.0 Hz, H<sub>2'(A)</sub>), 6.89 (dd, 1H, <sup>4</sup>J<sub>H6'(A)-H2'(A)</sub> = 2.0 Hz, <sup>3</sup>J<sub>H6'(A)-H5'(A)</sub> = 8.4 Hz, H<sub>6'(A)</sub>), 6.81 (dd, 1H, <sup>4</sup>J<sub>H6'(B)-H2'(B)</sub> = 1.9 Hz, <sup>3</sup>J<sub>H6'(B)-H5'(B)</sub> = 8.4 Hz, H<sub>6'(B)</sub>), 6.67 (m, 1H, H<sub>5'(A/B)</sub>), 5.00 (d, 1H, <sup>2</sup>J<sub>Hd(A)-Hd'(A)</sub> = 14.6 Hz, H<sub>d(A)</sub>), 4.89 (d, 1H, <sup>2</sup>J<sub>Hd(B)-Hd'(B)</sub> = 14.9 Hz, H<sub>d(B)</sub>), 4.25 (m, 3H, H<sub>b(A/B)</sub>, H<sub>d'(B)</sub>), 4.14 (d, 1H, <sup>2</sup>J<sub>Hd'(A)-Hd(A)</sub> = 14.6 Hz, H<sub>d'(A)</sub>), 3.71 (s, 3H, H<sub>h(B)</sub>), 3.69 (s, 3H, H<sub>h(A)</sub>), 1.50 (s, 9H, H<sub>g(B)</sub>), 1.29 (t, 3H, <sup>3</sup>J<sub>Hc(A/B)-Hb(A/B)</sub> = 7.1 Hz, H<sub>c(A/B)</sub>), 1.08 (s, 9H, H<sub>g(A)</sub>); <sup>13</sup>C NMR (100 MHz, CDCl<sub>3</sub>) δ 163.2 (C<sub>a(A)</sub>), 162.9 (C<sub>a(B)</sub>), 154.8 (C<sub>2(A/B)</sub>), 154.6 (C<sub>4'(A/B)</sub>), 153.5 (C<sub>4(B)</sub>), 153.0 (C<sub>4(A)</sub>), 149.4 (C<sub>e(B)</sub>), 148.8 (C<sub>e(A)</sub>), 148.5 (C<sub>8a(B)</sub>), 148.4 (C<sub>8a(A)</sub>), 134.6 (C<sub>5(A/B)</sub>), 131.1 (C<sub>2'(A/B)</sub>), 130.8 (C<sub>7(B)</sub>), 130.7 (C<sub>7(A)</sub>), 129.0 (C<sub>6'(A/B)</sub>), 128.9 (C<sub>1'(A/B)</sub>), 127.0 (C<sub>4a(B)</sub>), 126.9 (C<sub>4a(A)</sub>), 126.2 (C<sub>8(B)</sub>), 126.1 (C<sub>8(A)</sub>), 123.4 (C<sub>3(B)</sub>), 122.8 (C<sub>3(A)</sub>), 121.9 (C<sub>3'(A/B)</sub>), 116.4 (CN<sub>(B)</sub>), 116.3 (CN<sub>(A)</sub>), 111.8 (C<sub>5'(A)</sub>), 111.7 (C<sub>5'(B)</sub>), 111.4 (C<sub>6(B)</sub>), 111.3 (C<sub>6(A)</sub>), 82.5 (C<sub>f(B)</sub>), 81.6 (C<sub>f(A)</sub>), 62.2 (C<sub>b(A)</sub>), 62.0 (C<sub>b(B)</sub>), 55.8 (C<sub>h(A/B)</sub>), 54.3 (C<sub>d(B)</sub>), 53.2 (C<sub>d(A)</sub>), 28.1 (3C, C<sub>g(B)</sub>), 27.7 (3C, C<sub>g(A)</sub>), 13.8 (C<sub>c(A/B)</sub>); HRMS (ESI) *m/z* calculated for C<sub>26</sub>H<sub>26</sub><sup>35</sup>Cl<sup>79</sup>BrN<sub>3</sub>O<sub>5</sub> [M+H]<sup>+</sup>: 574.0744, found C<sub>26</sub>H<sub>26</sub><sup>35</sup>Cl<sup>79</sup>BrN<sub>3</sub>O<sub>5</sub> [M+H]<sup>+</sup>: 574.0799 (77%); C<sub>26</sub>H<sub>26</sub><sup>37</sup>Cl<sup>79</sup>BrN<sub>3</sub>O<sub>5</sub> or C<sub>26</sub>H<sub>26</sub><sup>35</sup>Cl<sup>81</sup>BrN<sub>3</sub>O<sub>5</sub> [M+H]<sup>+</sup>: 576.0721 (100%); C<sub>26</sub>H<sub>26</sub><sup>37</sup>Cl<sup>81</sup>BrN<sub>3</sub>O<sub>5</sub> [M+H]<sup>+</sup>: 578.0730 (24%).

#### 4.1.2.7. Ethyl 4-[(*tert*-butoxycarbonyl)-(3-chloro-4-methoxybenzyl)amino]-6-cyano-8-(3-fluoropropyl)quinoline-3-carboxylate (**19**):

Tetra-*n*-butylammonium fluoride (TBAF) solution (1.0 M in THF, 10 mL) was placed into a three-necked flask under argon atmosphere. The solvent was removed under reduced pressure in order to obtain anhydrous and pure TBAF. 3-Bromopropene (1.39 mL, 16.1 mmol, 1.0 eq.) was added and the resulting mixture was stirred at room temperature for 30 minutes. The product was then collected in a weighed gas trap with an anhydrous argon stream flow as carrier for three hours to produce allyl fluoride (310 mg, 5.16 mmol, 32%) as a colorless liquid at -60 °C (see Figure S1 in supporting information).

Under stirring an 0.5 M solution of 9-BBN in tetrahydrofuran (2.1 mL, 1.05 mmol, 2.0 eq.) was added at -10 °C to the allyl fluoride solution (10.0 eq.) in anhydrous and previously degassed tetrahydrofuran (3 mL). The resulting mixture was stirred at room temperature for 7 hours. This solution was added to a mixture of **18** (300 mg, 0.54 mmol, 1.0 eq.), tetrakis(triphenylphosphine)palladium(0) (60 mg, 51.9 μmol, 0.1 eq.), potassium carbonate (288 mg, 2.08 mmol, 4.0 eq.) and water (0.3 mL) in *N,N*-dimethylformamide (20 mL). The resulting mixture was stirred at 80 °C for 16 hours. After cooling to room temperature, water (30 mL) was added and the aqueous layer was extracted with ethyl acetate (3 × 30 mL). The combined organic layers were washed with brine (100 mL), dried over anhydrous magnesium sulfate, filtered and concentrated under reduced pressure. The crude residue was purified by column chromatography (SiO<sub>2</sub>, ethyl acetate/cyclohexane, 1/9, v/v) to give a mixture of **18** and **19** which was used in the next step without further purification (200 mg).

#### 4.1.2.8. *Tert*-butyl 3-chloro-4-methoxybenzyl[6-cyano-8-(3-fluoropropyl)-3-(hydroxymethyl)quinolin-4-yl]carbamate (**20**):



A 1.1 M solution of lithium tri-*tert*-butoxyaluminum hydride in tetrahydrofuran (0.8 mL, 0.88 mmol) was added to a mixture of crude **19** (100 mg) in anhydrous tetrahydrofuran (5 mL) under stirring and argon atmosphere. The resulting mixture was stirred at 60 °C for 20 hours. After cooling to room temperature, water (20 mL) was added under stirring. The solution was extracted with ethyl acetate (3 × 20 mL) and then with dichloromethane (2 × 20 mL). These two organic layers were separately washed with brine (100 mL). The combined organic layers were dried over anhydrous magnesium sulfate, filtered and concentrated under reduced pressure. The crude residue was purified by column chromatography (SiO<sub>2</sub>, ethanol/dichloromethane, 5/95, v/v) to give the desired product (20 mg, 38.9 μmol) as a white solid. Yield: 7%; R<sub>f</sub> (SiO<sub>2</sub>, ethanol/dichloromethane, 5/95, v/v): 0.43; Analyses of NMR spectra revealed that this product was a mixture of two rotamers, named A and B with a ratio A/B = 1/0.7; <sup>1</sup>H NMR (400 MHz, CDCl<sub>3</sub>) δ 9.18 (s, 1H, H<sub>2(B)</sub>), 9.15 (s, 1H, H<sub>2(A)</sub>), 8.08 (m, 1H, H<sub>5(A)</sub>), 7.85 (m, 1H, H<sub>5(B)</sub>), 7.75 (m, 1H, H<sub>7(A)</sub>), 7.72 (m, 1H, H<sub>7(B)</sub>), 7.13 (m, 1H, H<sub>2'(A)</sub>), 7.07 (m, 1H, H<sub>2'(B)</sub>), 7.04 (m, 1H, H<sub>6'(B)</sub>), 6.82 (m, 3H, H<sub>6'(A)</sub>, H<sub>5'(B)</sub>, H<sub>5'(A)</sub>), 5.17 (d, 1H, <sup>2</sup>J<sub>He(A)-He'(A)</sub> = 14.7 Hz, H<sub>e(A)</sub>), 5.08 (d, 1H, <sup>2</sup>J<sub>He(B)-He'(B)</sub> = 14.8 Hz, H<sub>e(B)</sub>), 4.55 (dt, 2H, <sup>3</sup>J<sub>Hi(A)-Hh(A)</sub> = 5.6 Hz, <sup>2</sup>J<sub>Hi(A)-F</sub> = 47.3 Hz, H<sub>i(A)</sub>), 4.36-4.29 (m, 3H, H<sub>i(B)</sub>, H<sub>e(A)</sub>, H<sub>e(B)</sub>), 4.17 (m, 4H, H<sub>a(A)</sub>, H<sub>a(B)</sub>), 3.90 (s, 3H, H<sub>f(B)</sub>), 3.89 (s, 3H, H<sub>f(A)</sub>), 3.44 (m, 4H, H<sub>g(A)</sub>, H<sub>g(B)</sub>), 2.22 (m, 4H, H<sub>h(A)</sub>, H<sub>h(B)</sub>), 1.65 (s, 9H, H<sub>d(A)</sub>), 1.26 (s, 9H, H<sub>d(B)</sub>); HRMS (ESI) *m/z* calculated for C<sub>27</sub>H<sub>30</sub><sup>35</sup>ClFN<sub>3</sub>O<sub>4</sub> [M+H]<sup>+</sup>: 514.1909, found C<sub>27</sub>H<sub>30</sub><sup>35</sup>ClFN<sub>3</sub>O<sub>4</sub> [M+H]<sup>+</sup>: 514.1953 (100%); C<sub>27</sub>H<sub>30</sub><sup>37</sup>ClFN<sub>3</sub>O<sub>4</sub> [M+H]<sup>+</sup>: 516.1985 (33%).

#### 4.1.2.9. 4-[(3-Chloro-4-methoxybenzyl)amino]-8-(3-fluoropropyl)-3-(hydroxymethyl)quinoline-6-carbonitrile (**5**):

Trifluoroacetic acid (1.0 mL) was added to a solution of **20** (20 mg, 38.9 μmol, 1.0 eq.) in anhydrous dichloromethane (2 mL) under argon atmosphere. The resulting mixture was stirred at rt for 3 hours and the solvent was evaporated under reduced pressure. The crude residue was purified by column chromatography (SiO<sub>2</sub>, ethanol/dichloromethane, 5/95, v/v) to give the desired product (5.0 mg, 12.1 μmol, 31%) as a white solid; R<sub>f</sub> (SiO<sub>2</sub>, ethanol/dichloromethane, 5/95, v/v): 0.19; IR (cm<sup>-1</sup>) ν 3412 (ν<sub>N-H</sub>), 2229 (ν<sub>C≡N</sub>), 1503 (δ<sub>N-H</sub>), 1259 (ν<sub>C-O</sub>), 1064 (ν<sub>C-O</sub>), 1020 (ν<sub>C-F</sub>); <sup>1</sup>H NMR (400 MHz, CDCl<sub>3</sub>) δ 8.53 (s, 1H, H<sub>2</sub>), 8.35 (d, 1H, <sup>4</sup>J<sub>H5-H7</sub> = 1.7 Hz, H<sub>5</sub>), 7.64 (d, 1H, <sup>4</sup>J<sub>H7-H5</sub> = 1.7 Hz, H<sub>7</sub>), 7.37 (d, 1H, <sup>4</sup>J<sub>H2'-H6'</sub> = 2.2 Hz, H<sub>2'</sub>), 7.21 (dd, 1H, <sup>4</sup>J<sub>H6'-H2'</sub> = 2.2 Hz, <sup>3</sup>J<sub>H6'-H5'</sub> = 8.4 Hz, H<sub>6'</sub>), 6.94 (d, 1H, <sup>3</sup>J<sub>H5'-H6'</sub> = 8.4 Hz, H<sub>5'</sub>), 4.77 (m, 4H, H<sub>a</sub>, H<sub>b</sub>), 4.53 (td, 2H, <sup>3</sup>J<sub>Hf-He</sub> = 5.9 Hz, <sup>2</sup>J<sub>Hf-F</sub> = 47.2 Hz, H<sub>f</sub>), 3.92 (s, 3H, H<sub>c</sub>), 3.32 (m, 2H, H<sub>d</sub>), 2.16 (m, 2H, H<sub>e</sub>); HRMS (ESI) *m/z* calculated for C<sub>22</sub>H<sub>22</sub><sup>35</sup>ClFN<sub>3</sub>O<sub>2</sub> [M+H]<sup>+</sup>: 414.1385, found C<sub>22</sub>H<sub>22</sub><sup>35</sup>ClFN<sub>3</sub>O<sub>2</sub> [M+H]<sup>+</sup>: 414.1357 (100%); C<sub>22</sub>H<sub>22</sub><sup>37</sup>ClFN<sub>3</sub>O<sub>2</sub> [M+H]<sup>+</sup>: 416.1244 (33%).

#### 4.1.2.10. Ethyl 4-[(3-chloro-4-methoxybenzyl)amino]-6-cyano-8-(4-fluoropiperidin-1-yl)quinoline-3-carboxylate (**21a**):

4-Fluoropiperidine hydrochloride (133 mg, 0.95 mmol, 3.0 eq.), palladium(II) acetate (7.1 mg, 31.6 μmol, 0.1 eq.), caesium carbonate (618 mg, 1.90 mmol, 6.0 eq.) and BINAP (39 mg, 62.6 μmol, 0.2 eq.) were successively added to a solution of **14** [28] (150 mg, 0.32 mmol, 1 eq.) in anhydrous toluene (10 mL) in a sealed flask under stirring and argon atmosphere. The resulting

mixture was refluxed for 3 hours. After cooling to room temperature, the mixture was filtered through Celite® 545 and washed with dichloromethane (60 mL). The filtrate was concentrated under reduced pressure and the crude product was purified by column chromatography (SiO<sub>2</sub>, ethyl acetate/cyclohexane, 4/6, v/v) to give the desired product (90 mg, 0.18 mmol, 56%) as a light yellow solid. R<sub>f</sub> (SiO<sub>2</sub>, ethyl acetate/cyclohexane, 4/6, v/v): 0.24; Mp: 110 ± 1 °C; IR (cm<sup>-1</sup>) ν 2226 (ν<sub>C≡N</sub>), 1669 (ν<sub>C=O</sub>), 1502 (δ<sub>N-H</sub>), 1261 (ν<sub>C-O</sub>), 1183 (ν<sub>C-O</sub>), 1027 (ν<sub>C-F</sub>); <sup>1</sup>H NMR (400 MHz, CDCl<sub>3</sub>) δ 9.47 (brs, 1H, NH), 9.19 (s, 1H, H<sub>2</sub>), 8.07 (d, 1H, <sup>4</sup>J<sub>H5-H7</sub> = 1.2 Hz, H<sub>5</sub>), 7.38 (d, 1H, <sup>4</sup>J<sub>H2'-H6'</sub> = 2.2 Hz, H<sub>2'</sub>), 7.24 (dd, 1H, <sup>3</sup>J<sub>H6'-H5'</sub> = 8.4 Hz, <sup>4</sup>J<sub>H6'-H2'</sub> = 2.2 Hz, H<sub>6'</sub>), 7.21 (m, 1H, H<sub>7</sub>), 6.96 (d, 1H, <sup>3</sup>J<sub>H5'-H6'</sub> = 8.4 Hz, H<sub>5'</sub>), 4.93 (m, 1H, H<sub>h</sub>), 4.82 (d, 2H, <sup>3</sup>J<sub>Hd-NH</sub> = 5.6 Hz, H<sub>d</sub>), 4.37 (q, 2H, <sup>3</sup>J<sub>Hb-Hc</sub> = 7.1 Hz, H<sub>b</sub>), 3.91 (s, 3H, H<sub>e</sub>), 3.40 (m, 4H, H<sub>f</sub>, H<sub>f'</sub>), 2.15 (m, 4H, H<sub>g</sub>, H<sub>g'</sub>), 1.40 (t, 3H, <sup>3</sup>J<sub>Hc-Hb</sub> = 7.1 Hz, H<sub>c</sub>); <sup>13</sup>C NMR (100 MHz, CDCl<sub>3</sub>) δ 168.2 (C<sub>a</sub>), 157.0 (C<sub>4</sub>), 154.9 (C<sub>4'</sub>), 151.7 (C<sub>2</sub>), 150.8 (C<sub>8</sub>), 147.5 (C<sub>8a</sub>), 130.7 (C<sub>1'</sub>), 129.3 (C<sub>2'</sub>), 126.8 (C<sub>6'</sub>), 125.0 (C<sub>5</sub>), 123.1 (C<sub>3'</sub>), 120.0 (C<sub>4a</sub>), 119.3 (CN), 118.1 (C<sub>7</sub>), 112.5 (C<sub>5'</sub>), 107.4 (C<sub>6</sub>), 104.8 (C<sub>3</sub>), 88.1 (d, <sup>1</sup>J<sub>CH-F</sub> = 170 Hz, C<sub>h</sub>), 61.2 (C<sub>b</sub>), 56.2 (C<sub>e</sub>), 52.1 (C<sub>d</sub>), 47.9 (d, 2C, <sup>3</sup>J<sub>Cf/f'-F</sub> = 5 Hz, C<sub>f</sub>, C<sub>f'</sub>), 31.5 (d, 2C, <sup>2</sup>J<sub>Cg/g'-F</sub> = 20 Hz, C<sub>g</sub>, C<sub>g'</sub>), 14.3 (C<sub>c</sub>); HRMS (ESI) *m/z* calculated for C<sub>26</sub>H<sub>27</sub><sup>35</sup>CIFN<sub>4</sub>O<sub>3</sub> [M+H]<sup>+</sup>: 497.1756, found C<sub>26</sub>H<sub>27</sub><sup>35</sup>CIFN<sub>4</sub>O<sub>3</sub> [M+H]<sup>+</sup>: 497.1751 (100%); C<sub>26</sub>H<sub>27</sub><sup>37</sup>CIFN<sub>4</sub>O<sub>3</sub> [M+H]<sup>+</sup>: 499.1850 (33%).

#### 4.1.2.11. Ethyl 4-[(3-chloro-4-methoxybenzyl)amino]-6-cyano-8-(3-fluoroazetidino-1-yl)quinoline-3-carboxylate (21b):

In a sealed flask compound **14** [28] (0.26 g, 0.55 mmol, 1.0 eq.) was diluted in anhydrous toluene (20 mL) and 3-fluoroazetidino hydrochloride (91 mg, 0.82 mmol, 1.5 eq.), palladium(II) acetate (12 mg, 53.4 μmol, 0.1 eq.), caesium carbonate (0.71 g, 2.18 mmol, 4.0 eq.), and BINAP (68 mg, 0.11 mmol, 0.2 eq.) were successively added under argon atmosphere. The resulting mixture was stirred at 120 °C for 3 hours. After cooling to room temperature, the mixture was filtered on Celite® 545 and washed with ethyl acetate (40 mL). The filtrate was concentrated under reduced pressure and the crude residue was purified by column chromatography (SiO<sub>2</sub>, ethyl acetate/cyclohexane, 2/8, v/v) to give the desired product (0.20 g, 0.43 mmol, 78%) as a yellow solid. R<sub>f</sub> (SiO<sub>2</sub>, cyclohexane/ethyl acetate, 7/3, v/v): 0.41; Mp: 155 ± 1 °C; IR (cm<sup>-1</sup>) ν 2227 (ν<sub>C≡N</sub>), 1670 (ν<sub>C=O</sub>), 1590 (δ<sub>N-H</sub>), 1504 (ν<sub>C=C</sub>), 1437 (δ<sub>CH2</sub>), 1067 (ν<sub>C-O</sub>), 1180 (ν<sub>C-O</sub>), 1066 (ν<sub>C-O</sub>), 1024 (ν<sub>C-F</sub>); <sup>1</sup>H NMR (400 MHz, CDCl<sub>3</sub>) δ 9.40 (brs, 1H, NH), 9.02 (s, 1H, H<sub>2</sub>), 7.79 (d, 1H, <sup>4</sup>J<sub>H5-H7</sub> = 1.4 Hz, H<sub>5</sub>), 7.36 (d, 1H, <sup>4</sup>J<sub>H2'-H6'</sub> = 2.2 Hz, H<sub>2'</sub>), 7.23 (dd, 1H, <sup>3</sup>J<sub>H6'-H5'</sub> = 8.4 Hz, <sup>4</sup>J<sub>H6'-H2'</sub> = 2.2 Hz, H<sub>6'</sub>), 6.94 (d, 1H, <sup>4</sup>J<sub>H5'-H6'</sub> = 8.4 Hz, H<sub>5'</sub>), 6.57 (d, 1H, <sup>4</sup>J<sub>H7-H5</sub> = 1.4 Hz, H<sub>7</sub>), 5.44 (m, 1H, H<sub>g</sub>), 4.79 (d, 2H, <sup>3</sup>J<sub>Hd-NH</sub> = 5.5 Hz, H<sub>d</sub>), 4.61 (m, 2H, H<sub>f</sub> or H<sub>f'</sub>), 4.35 (q, 2H, <sup>3</sup>J<sub>Hb-Hc</sub> = 7.1 Hz, H<sub>b</sub>), 4.27 (m, 2H, H<sub>f</sub> or H<sub>f'</sub>), 3.90 (s, 3H, H<sub>e</sub>), 1.39 (t, 3H, <sup>3</sup>J<sub>Hc-Hb</sub> = 7.1 Hz, H<sub>c</sub>); <sup>13</sup>C NMR (100 MHz, CDCl<sub>3</sub>) δ 168.4 (C<sub>a</sub>), 156.3 (C<sub>4</sub>), 154.9 (C<sub>4'</sub>), 150.6 (C<sub>2</sub>), 148.2 (C<sub>8</sub>), 144.5 (C<sub>8a</sub>), 130.9 (C<sub>1'</sub>), 129.4 (C<sub>2'</sub>), 126.9 (C<sub>6'</sub>), 123.1 (C<sub>3'</sub>), 120.7 (C<sub>5</sub>), 119.5 (2C, CN, C<sub>4a</sub>), 112.5 (C<sub>5'</sub>), 110.9 (C<sub>7</sub>), 107.7 (C<sub>6</sub>), 104.9 (C<sub>3</sub>), 83.4 (d, <sup>1</sup>J<sub>Cg-F</sub> = 201 Hz, C<sub>g</sub>), 62.1 (C<sub>f</sub> or C<sub>f'</sub>), 61.9 (C<sub>f</sub> or C<sub>f'</sub>), 61.2 (C<sub>b</sub>), 56.3 (C<sub>e</sub>), 51.9 (C<sub>d</sub>), 14.3 (C<sub>c</sub>); HRMS (ESI) *m/z* calculated for C<sub>24</sub>H<sub>23</sub><sup>35</sup>CIFN<sub>4</sub>O<sub>3</sub> [M+H]<sup>+</sup>: 469.1443, found C<sub>24</sub>H<sub>23</sub><sup>35</sup>CIFN<sub>4</sub>O<sub>3</sub> [M+H]<sup>+</sup>: 469.1453 (100%); C<sub>24</sub>H<sub>23</sub><sup>37</sup>CIFN<sub>4</sub>O<sub>3</sub> [M+H]<sup>+</sup>: 471.1489 (33%).

#### 4.1.2.12. Ethyl 4-[(3-chloro-4-methoxybenzyl)amino]-6-cyano-8-[[[(6-fluoro-5-methoxypyridin-2-yl)methyl]amino]quinoline-3-carboxylate (21c):

The crude product **10a** (2.0 g, synthesis in supporting information) was dissolved in water (20 mL) before addition of a saturated aqueous sodium bicarbonate solution (20 mL, pH 7/8). This aqueous mixture was extracted with dichloromethane (5 × 30 mL). The combined organic layers were washed with brine (100 mL), dried over magnesium sulfate, filtered and concentrated under reduced pressure. The obtained residue (350 mg) was dissolved in anhydrous toluene (3 mL) under argon atmosphere. The resulting solution was added to a mixture of **14** [28] (0.30 g, 0.63 mmol, 1.0 eq.), palladium(II) acetate (14 mg, 62.4 μmol, 0.1 eq.), caesium carbonate (1.03 g, 3.16 mmol, 5.0 eq.) and BINAP (79 mg, 0.13 mmol, 0.2 eq.) in anhydrous toluene (10 mL) under argon atmosphere. The resulting mixture was refluxed for 6 hours. After cooling to room temperature, the mixture was filtered through a Celite<sup>®</sup> 545 pad and washed with dichloromethane (100 mL). The filtrate was concentrated under reduced pressure and the crude product was purified by column chromatography (SiO<sub>2</sub>, ethyl acetate/cyclohexane, 3/7, v/v) to give the desired product (200 mg, 0.36 mmol, 58%) as a yellow solid. R<sub>f</sub> (SiO<sub>2</sub>, ethyl acetate/cyclohexane, 3/7, v/v): 0.19; Mp: 175 ± 1°C; IR (cm<sup>-1</sup>) ν 2231 (ν<sub>C≡N</sub>), 1670 (ν<sub>C=O</sub>), 1505 (δ<sub>N-H</sub>), 1265 (ν<sub>C-O</sub>), 1181 (ν<sub>C-O</sub>), 1065 (ν<sub>C-O</sub>), 1022 (ν<sub>C-F</sub>); <sup>1</sup>H NMR (400 MHz, CDCl<sub>3</sub>) δ 9.55 (t, 1H, <sup>3</sup>J<sub>Hd-He</sub> = 5.2 Hz, H<sub>d</sub>), 9.04 (s, 1H, H<sub>2</sub>), 7.71 (d, 1H, <sup>4</sup>J<sub>H5-H7</sub> = 1.1 Hz, H<sub>5</sub>), 7.37 (d, 1H, <sup>4</sup>J<sub>H2'-H6'</sub> = 2.1 Hz, H<sub>2'</sub>), 7.23 (m, 2H, H<sub>6'</sub>, H<sub>11'</sub>), 7.11 (m, 2H, H<sub>10'</sub>, H<sub>g</sub>), 6.94 (d, 1H, <sup>3</sup>J<sub>H5'-H6'</sub> = 8.5 Hz, H<sub>5'</sub>), 6.58 (d, 1H, <sup>4</sup>J<sub>H7-H5</sub> = 1.1 Hz, H<sub>7</sub>), 4.84 (d, 2H, <sup>3</sup>J<sub>He-Hd</sub> = 5.4 Hz, H<sub>e</sub>), 4.47 (d, 2H, <sup>3</sup>J<sub>Hh-Hg</sub> = 5.6 Hz, H<sub>h</sub>), 4.35 (q, 2H, <sup>3</sup>J<sub>Hb-Hc</sub> = 7.1 Hz, H<sub>b</sub>), 3.90 (s, 3H, H<sub>f</sub>), 3.88 (s, 3H, H<sub>i</sub>), 1.39 (t, 3H, <sup>3</sup>J<sub>Hc-Hb</sub> = 7.1 Hz, H<sub>c</sub>); <sup>13</sup>C NMR (100 MHz, CDCl<sub>3</sub>) δ 168.5 (C<sub>a</sub>), 156.3 (C<sub>4</sub>), 154.9 (C<sub>4'</sub>), 153.2 (d, <sup>1</sup>J<sub>C8'-F</sub> = 240 Hz, C<sub>8'</sub>), 151.1 (C<sub>2</sub>), 145.6 (d, <sup>3</sup>J<sub>C12'-F</sub> = 10 Hz, C<sub>12'</sub>), 145.1 (C<sub>8</sub>), 142.0 (2C, C<sub>8a</sub>, C<sub>9'</sub>), 130.8 (C<sub>1'</sub>), 129.4 (C<sub>2'</sub>), 126.9 (C<sub>6'</sub>), 123.1 (C<sub>3'</sub>), 122.4 (d, <sup>3</sup>J<sub>C10'-F</sub> = 4 Hz, C<sub>10'</sub>), 119.9 (CN), 118.9 (d, <sup>4</sup>J<sub>C11'-F</sub> = 4 Hz, C<sub>11'</sub>), 118.6 (C<sub>5</sub>), 118.3 (C<sub>4a</sub>), 112.5 (C<sub>5'</sub>), 108.1 (C<sub>6</sub>), 106.7 (C<sub>7</sub>), 104.9 (C<sub>3</sub>), 61.3 (C<sub>b</sub>), 56.4 (C<sub>i</sub>), 56.3 (C<sub>f</sub>), 51.7 (C<sub>e</sub>), 47.5 (C<sub>h</sub>), 14.3 (C<sub>c</sub>); HRMS (ESI) *m/z* calculated for C<sub>28</sub>H<sub>26</sub><sup>35</sup>ClFN<sub>5</sub>O<sub>4</sub> [M+H]<sup>+</sup>: 550.1657, found C<sub>28</sub>H<sub>26</sub><sup>35</sup>ClFN<sub>5</sub>O<sub>4</sub> [M+H]<sup>+</sup>: 550.1661 (100%); C<sub>28</sub>H<sub>26</sub><sup>37</sup>ClFN<sub>5</sub>O<sub>4</sub> [M+H]<sup>+</sup>: 552.1703 (33%).

#### 4.1.2.13. Ethyl 4-[(3-chloro-4-methoxybenzyl)amino]-6-cyano-8-[[[(6-fluoropyridin-2-yl)methyl]amino]quinoline-3-carboxylate (21d):

The crude product **10b** (0.14 g, synthesis in supporting information) was dissolved in dichloromethane (30 mL) before addition of a saturated aqueous sodium hydrogen carbonate solution (50 mL, pH 8-9). After decantation, the aqueous layer was extracted with dichloromethane (7 × 30 mL). The combined organic layers were washed with brine (40 mL), dried over magnesium sulfate, filtered and concentrated under reduced pressure to obtain (6-fluoropyridine-2-yl)methylamine (0.13 g, 1.27 mmol, 3.0 eq.) as a yellow oil. This residue was dissolved, under argon atmosphere, in a mixture of **14**[28] (160 mg, 0.34 mmol, 1.0 eq.), palladium(II) acetate (7.6 mg, 33.9 μmol, 0.1 eq.), caesium carbonate (549 mg, 1.69 mmol, 5.0 eq.), and BINAP (42 mg, 67.5 μmol, 0.2 eq.) in anhydrous toluene (15 mL). The resulting mixture was refluxed for 4 hours in a sealed flask. After cooling to room temperature, the reaction mixture was filtered on Celite<sup>®</sup> 545 and washed with dichloromethane (210 mL). The

filtrate was concentrated under reduced pressure and the crude residue was purified by column chromatography (SiO<sub>2</sub>, ethyl acetate/cyclohexane, 3/7, v/v) to give the desired product **21d** (163 mg, 0.31 mmol, 93%) as an orange solid. R<sub>f</sub>(SiO<sub>2</sub>, cyclohexane/ethyl acetate, 7/3, v/v): 0.38; Mp: 152 ± 1 °C; IR (cm<sup>-1</sup>) ν 2229 (ν<sub>C≡N</sub>), 1669 (ν<sub>C=O</sub>), 1594 (δ<sub>N-H</sub>), 1531 (δ<sub>N-H</sub>), 1501 (ν<sub>C=C</sub>), 1434 (δ<sub>CH3</sub>), 1252 (ν<sub>C-O</sub>), 1191 (ν<sub>C-O</sub>), 1064 (ν<sub>C-O</sub>), 1023 (ν<sub>C-F</sub>); <sup>1</sup>H NMR (400 MHz, CDCl<sub>3</sub>) δ 9.61 (brs, 1H, H<sub>d</sub>), 9.05 (s, 1H, H<sub>2</sub>), 7.73 (m, 2H, H<sub>5</sub>, H<sub>10'</sub>), 7.38 (d, 1H, <sup>4</sup>J<sub>H2'-H6'</sub> = 2.2 Hz, H<sub>2'</sub>), 7.23 (m, 3H, H<sub>6'</sub>, H<sub>11'</sub>, H<sub>g</sub>), 6.94 (d, 1H, <sup>3</sup>J<sub>H5'-H6'</sub> = 8.5 Hz, H<sub>5'</sub>), 6.84 (m, 1H, H<sub>9'</sub>), 6.59 (d, 1H, <sup>4</sup>J<sub>H7-H5</sub> = 1.1 Hz, H<sub>7</sub>), 4.85 (d, 2H, <sup>3</sup>J<sub>He-Hd</sub> = 5.4 Hz, H<sub>e</sub>), 4.57 (d, 2H, <sup>3</sup>J<sub>Hh-Hg</sub> = 6.0 Hz, H<sub>h</sub>), 4.36 (q, 2H, <sup>3</sup>J<sub>Hb-Hc</sub> = 7.1 Hz, H<sub>b</sub>), 3.90 (s, 3H, H<sub>f</sub>), 1.39 (t, 3H, <sup>3</sup>J<sub>Hc-Hb</sub> = 7.1 Hz, H<sub>c</sub>); <sup>13</sup>C NMR (100 MHz, CDCl<sub>3</sub>) δ 168.4 (C<sub>a</sub>), 163.5 (d, <sup>1</sup>J<sub>C8'-F</sub> = 239 Hz, C<sub>8'</sub>), 157.1 (d, <sup>3</sup>J<sub>C12'-F</sub> = 13 Hz, C<sub>12'</sub>), 156.4 (C<sub>4</sub>), 155.0 (C<sub>4'</sub>), 150.9 (C<sub>2</sub>), 144.9 (C<sub>8</sub>), 141.9 (d, <sup>3</sup>J<sub>C10'-F</sub> = 8 Hz, C<sub>10'</sub>), 141.8 (C<sub>8a</sub>), 130.6 (C<sub>1'</sub>), 129.4 (C<sub>2'</sub>), 126.9 (C<sub>6'</sub>), 123.1 (C<sub>3'</sub>), 119.8 (CN), 118.7 (2C, C<sub>5</sub>, C<sub>3</sub>), 118.3 (d, <sup>4</sup>J<sub>C11'-F</sub> = 4 Hz, C<sub>11'</sub>), 112.6 (C<sub>5'</sub>), 108.3 (C<sub>6</sub>), 108.2 (d, <sup>2</sup>J<sub>C9'-F</sub> = 37 Hz, C<sub>9'</sub>), 106.9 (C<sub>7</sub>), 104.9 (C<sub>4a</sub>), 61.3 (C<sub>b</sub>), 56.3 (C<sub>f</sub>), 51.7 (C<sub>e</sub>), 48.2 (C<sub>h</sub>), 14.3 (C<sub>c</sub>); HRMS (ESI) *m/z* calculated for C<sub>27</sub>H<sub>24</sub><sup>35</sup>ClFN<sub>5</sub>O<sub>3</sub> [M+H]<sup>+</sup>: 520.1552, found C<sub>27</sub>H<sub>24</sub><sup>35</sup>ClFN<sub>5</sub>O<sub>3</sub> [M+H]<sup>+</sup>: 520.1584 (100%); C<sub>27</sub>H<sub>24</sub><sup>37</sup>ClFN<sub>5</sub>O<sub>3</sub> [M+H]<sup>+</sup>: 522.1701 (33%).

#### 4.1.2.14. General procedure for 6-9:

A 1.1 M solution of lithium tri-*tert*-butoxyaluminum hydride in tetrahydrofuran (0.99 mL, 1.1 mmol, 6.0 eq. for **6**, **7** and **8**, 10.0 eq. for **9**) was added, under stirring and argon atmosphere, to a solution of **21a-d** (1.0 eq.) in anhydrous tetrahydrofuran (15 mL). The resulting mixture was stirred at 60 °C for 20 hours. After cooling to room temperature, water (20 mL) was added under stirring. The aqueous layer was extracted with ethyl acetate (3 x 40 mL), and dichloromethane (3 x 30 mL). These two organic layers were separately washed with brine (100 mL). The combined organic layers were dried over sodium sulfate, filtered and concentrated under reduced pressure. The crude product was purified by column chromatography (SiO<sub>2</sub>, ethanol/dichloromethane, 5/95, v/v) to give the desired products.

##### 4.1.2.14.1. 4-[(3-Chloro-4-methoxybenzyl)amino]-8-(4-fluoropiperidin-1-yl)-3-(hydroxymethyl)quinoline-6-carbonitrile (**6**):

Yellow solid; yield 31% (25 mg, 55.0 μmol); R<sub>f</sub>(SiO<sub>2</sub>, ethanol/dichloromethane, 5/95, v/v): 0.14; Mp: 215 ± 1 °C; IR (cm<sup>-1</sup>) ν 2226 (ν<sub>C≡N</sub>), 1504 (δ<sub>N-H</sub>), 1256 (ν<sub>C-O</sub>), 1064 (ν<sub>C-O</sub>), 1015 (ν<sub>C-F</sub>); <sup>1</sup>H NMR (400 MHz, DMSO-*d*<sub>6</sub>) δ 8.47 (m, 1H, H<sub>5</sub>), 8.43 (s, 1H, H<sub>2</sub>), 7.42 (m, 1H, NH), 7.39 (d, 1H, <sup>4</sup>J<sub>H2'-H6'</sub> = 2.1 Hz, H<sub>2'</sub>), 7.27 (m, 1H, H<sub>7</sub>), 7.23 (dd, 1H, <sup>3</sup>J<sub>H6'-H5'</sub> = 8.5 Hz, <sup>4</sup>J<sub>H6'-H2'</sub> = 2.1 Hz, H<sub>6'</sub>), 7.10 (d, 1H, <sup>3</sup>J<sub>H5'-H6'</sub> = 8.5 Hz, H<sub>5'</sub>), 5.41 (t, 1H, <sup>3</sup>J<sub>OH-Ha</sub> = 4.9 Hz, OH), 4.88 (m, 1H, H<sub>f</sub>), 4.79 (d, 2H, <sup>3</sup>J<sub>Hb-NH</sub> = 6.7 Hz, H<sub>b</sub>), 4.44 (d, 2H, <sup>3</sup>J<sub>Ha-OH</sub> = 4.9 Hz, H<sub>a</sub>), 3.81 (s, 3H, H<sub>c</sub>), 3.35 (m, 4H, H<sub>d</sub>, H<sub>d'</sub>), 2.02 (m, 4H, H<sub>e</sub>, H<sub>e'</sub>); <sup>13</sup>C NMR (100 MHz, DMSO-*d*<sub>6</sub>) δ 153.4 (C<sub>4'</sub>), 153.1 (C<sub>2</sub>), 150.4 (C<sub>4</sub>), 149.8 (C<sub>8</sub>), 143.9 (C<sub>8a</sub>), 134.1 (C<sub>1'</sub>), 127.8 (C<sub>2'</sub>), 126.2 (C<sub>6'</sub>), 122.0 (C<sub>5</sub>), 121.0 (C<sub>3'</sub>), 120.7 (C<sub>4a</sub>), 119.7 (CN), 115.8 (C<sub>7</sub>), 115.7 (C<sub>3</sub>), 112.9 (C<sub>5'</sub>), 106.6 (C<sub>6</sub>), 88.5 (d, <sup>1</sup>J<sub>Cf-F</sub> = 168 Hz, C<sub>f</sub>), 59.6 (C<sub>a</sub>), 56.1 (C<sub>c</sub>), 47.6 (C<sub>b</sub>), 47.5 (2C, C<sub>d</sub>, C<sub>d'</sub>), 31.3 (d, 2C, <sup>2</sup>J<sub>Ce/e'-F</sub> = 19 Hz, C<sub>e</sub>, C<sub>e'</sub>); HRMS (ESI) *m/z* calculated for C<sub>24</sub>H<sub>25</sub><sup>35</sup>ClFN<sub>4</sub>O<sub>2</sub> [M+H]<sup>+</sup>: 455.1650, found C<sub>24</sub>H<sub>25</sub><sup>35</sup>ClFN<sub>4</sub>O<sub>2</sub> [M+H]<sup>+</sup>: 455.1617 (100%); C<sub>24</sub>H<sub>25</sub><sup>37</sup>ClFN<sub>4</sub>O<sub>2</sub> [M+H]<sup>+</sup>: 457.1621 (33%).

**4.1.2.14.2. 4-[(3-Chloro-4-methoxybenzyl)amino]-8-(3-fluoroazetidin-1-yl)-3-(hydroxymethyl)quinoline-6-carbonitrile (7):**

Yellow solid; yield 55% (90 mg, 0.21 mmol);  $R_f$  (SiO<sub>2</sub>, ethanol/dichloromethane, 5/95, v/v): 0.47; Mp: 162 ± 1 °C; IR (cm<sup>-1</sup>)  $\nu$  3396 ( $\nu_{N-H}$ ), 2228 ( $\nu_{C\equiv N}$ ), 1503 ( $\delta_{N-H}$ ), 1281 ( $\nu_{C-O}$ ), 1260 ( $\nu_{C-O}$ ), 1065 ( $\nu_{C-O}$ ); <sup>1</sup>H NMR (400 MHz, DMSO-d<sub>6</sub>)  $\delta$  8.33 (s, 1H, H<sub>2</sub>), 8.14 (d, 1H, <sup>4</sup>J<sub>H5-H7</sub> = 1.4 Hz, H<sub>5</sub>), 7.36 (d, 1H, <sup>4</sup>J<sub>H2'-H6'</sub> = 2.1 Hz, H<sub>2'</sub>), 7.24 (m, 1H, NH), 7.21 (dd, 1H, <sup>4</sup>J<sub>H6'-H2'</sub> = 2.1 Hz, <sup>3</sup>J<sub>H6'-H5'</sub> = 8.4 Hz, H<sub>6'</sub>), 7.10 (d, 1H, <sup>3</sup>J<sub>H5'-H6'</sub> = 8.4 Hz, H<sub>5'</sub>), 6.69 (d, 1H, <sup>4</sup>J<sub>H7-H5</sub> = 1.4 Hz, H<sub>7</sub>), 5.47 (m, 1H, H<sub>e</sub>), 5.36 (t, 1H, <sup>3</sup>J<sub>OH-Ha</sub> = 5.2 Hz, OH), 4.76 (d, 2H, <sup>3</sup>J<sub>Hb-NH</sub> = 6.7 Hz, H<sub>b</sub>), 4.54 (m, 2H, H<sub>d</sub> or H<sub>d'</sub>), 4.41 (d, 2H, <sup>3</sup>J<sub>Ha-OH</sub> = 5.2 Hz, H<sub>a</sub>), 4.25 (m, 2H, H<sub>d</sub> or H<sub>d'</sub>), 3.81 (s, 3H, H<sub>c</sub>); <sup>13</sup>C NMR (100 MHz, DMSO-d<sub>6</sub>)  $\delta$  153.4 (C<sub>4'</sub>), 152.8 (C<sub>2</sub>), 149.4 (C<sub>4</sub>), 147.8 (C<sub>8</sub>), 141.6 (C<sub>8a</sub>), 134.3 (C<sub>1'</sub>), 127.8 (C<sub>2'</sub>), 126.1 (C<sub>6'</sub>), 121.0 (C<sub>3'</sub>), 120.4 (C<sub>4a</sub>), 119.9 (CN), 117.2 (C<sub>5</sub>), 115.9 (C<sub>3</sub>), 112.9 (C<sub>5'</sub>), 108.1 (C<sub>7</sub>), 106.9 (C<sub>6</sub>), 84.3 (d, <sup>1</sup>J<sub>Ce-F</sub> = 196 Hz, C<sub>e</sub>), 61.7 (d, 2C, <sup>2</sup>J<sub>Cd/d'-F</sub> = 5 Hz, C<sub>d/d'</sub>), 59.7 (C<sub>a</sub>), 56.0 (C<sub>c</sub>), 47.5 (C<sub>b</sub>); HRMS (ESI)  $m/z$  calculated for C<sub>22</sub>H<sub>21</sub><sup>35</sup>ClFN<sub>4</sub>O<sub>2</sub> [M+H]<sup>+</sup>: 427.1337, found C<sub>22</sub>H<sub>21</sub><sup>35</sup>ClFN<sub>4</sub>O<sub>2</sub> [M+H]<sup>+</sup>: 427.1350 (100%); C<sub>22</sub>H<sub>21</sub><sup>37</sup>ClFN<sub>4</sub>O<sub>2</sub> [M+H]<sup>+</sup>: 429.1253 (33%).

**4.1.2.14.3. 4-[(3-chloro-4-methoxybenzyl)amino]-8-[(6-fluoro-5-methoxypyridin-2-yl)methyl]amino]-3-(hydroxymethyl)quinoline-6-carbonitrile (8):**

Light yellow solid; yield 55% (80 mg, 0.16 mmol);  $R_f$  (SiO<sub>2</sub>, ethanol/dichloromethane, 5/95, v/v): 0.40; Mp: 194 ± 1 °C; IR (cm<sup>-1</sup>)  $\nu$  3409 ( $\nu_{N-H}$ ), 2227 ( $\nu_{C\equiv N}$ ), 1546 ( $\delta_{N-H}$ ), 1260 ( $\nu_{C-O}$ ), 1004 ( $\nu_{C-F}$ ); <sup>1</sup>H NMR (400 MHz, DMSO-d<sub>6</sub>)  $\delta$  8.38 (s, 1H, H<sub>2</sub>), 8.01 (d, 1H, <sup>4</sup>J<sub>H5-H7</sub> = 1.2 Hz, H<sub>5</sub>), 7.59 (dd, 1H, <sup>4</sup>J<sub>H10'-F</sub> = 10.6 Hz, <sup>3</sup>J<sub>H10'-H11'</sub> = 8.2 Hz, H<sub>10'</sub>), 7.45 (t, 1H, <sup>3</sup>J<sub>He-Hf</sub> = 6.3 Hz, H<sub>e</sub>), 7.37 (d, 1H, <sup>4</sup>J<sub>H2'-H6'</sub> = 2.1 Hz, H<sub>2'</sub>), 7.33 (t, 1H, <sup>3</sup>J<sub>Hb-Hc</sub> = 6.8 Hz, H<sub>b</sub>), 7.25 (d, 1H, <sup>3</sup>J<sub>H11'-H10'</sub> = 8.2 Hz, H<sub>11'</sub>), 7.21 (dd, 1H, <sup>3</sup>J<sub>H6'-H5'</sub> = 8.5 Hz, <sup>4</sup>J<sub>H6'-H2'</sub> = 2.1 Hz, H<sub>6'</sub>), 7.10 (d, 1H, <sup>3</sup>J<sub>H5'-H6'</sub> = 8.5 Hz, H<sub>5'</sub>), 6.65 (d, 1H, <sup>4</sup>J<sub>H7-H5</sub> = 1.2 Hz, H<sub>7</sub>), 5.39 (t, 1H, <sup>3</sup>J<sub>OH-Ha</sub> = 5.1 Hz, OH), 4.79 (d, 2H, <sup>3</sup>J<sub>Hc-Hb</sub> = 6.8 Hz, H<sub>c</sub>), 4.49 (d, 2H, <sup>3</sup>J<sub>Hf-He</sub> = 6.3 Hz, H<sub>f</sub>), 4.44 (d, 2H, <sup>3</sup>J<sub>Ha-OH</sub> = 5.1 Hz, H<sub>a</sub>), 3.84 (s, 3H, H<sub>g</sub>), 3.81 (s, 3H, H<sub>d</sub>); <sup>13</sup>C NMR (100 MHz, DMSO-d<sub>6</sub>)  $\delta$  153.4 (C<sub>4'</sub>), 152.8 (C<sub>2</sub>), 151.9 (d, <sup>1</sup>J<sub>C8'-F</sub> = 235 Hz, C<sub>8'</sub>), 149.9 (C<sub>4</sub>), 146.1 (d, <sup>3</sup>J<sub>C12'-F</sub> = 11 Hz, C<sub>12'</sub>), 145.0 (C<sub>3</sub>), 140.8 (d, <sup>2</sup>J<sub>C9'-F</sub> = 15 Hz, C<sub>9'</sub>), 139.3 (C<sub>8a</sub>), 134.3 (C<sub>1'</sub>), 127.7 (C<sub>2'</sub>), 126.1 (C<sub>6'</sub>), 123.5 (d, <sup>3</sup>J<sub>C10'-F</sub> = 3 Hz, C<sub>10'</sub>), 121.0 (C<sub>3'</sub>), 120.3 (CN), 119.7 (d, <sup>4</sup>J<sub>C11'-F</sub> = 3 Hz, C<sub>11'</sub>), 119.2 (C<sub>4a</sub>), 116.1 (C<sub>3</sub>), 114.8 (C<sub>5</sub>), 112.9 (C<sub>5'</sub>), 107.2 (C<sub>6</sub>), 103.6 (C<sub>7</sub>), 59.7 (C<sub>a</sub>), 56.1 (C<sub>g</sub>), 56.0 (C<sub>d</sub>), 47.3 (C<sub>c</sub>), 46.2 (C<sub>f</sub>); HRMS (ESI)  $m/z$  calculated for C<sub>26</sub>H<sub>24</sub><sup>35</sup>ClFN<sub>5</sub>O<sub>3</sub> [M+H]<sup>+</sup>: 508.1552, found C<sub>26</sub>H<sub>24</sub><sup>35</sup>ClFN<sub>5</sub>O<sub>3</sub> [M+H]<sup>+</sup>: 508.1528 (100%); C<sub>26</sub>H<sub>24</sub><sup>37</sup>ClFN<sub>5</sub>O<sub>3</sub> [M+H]<sup>+</sup>: 510.1570 (33%).

**4.1.2.14.4. 4-[(3-Chloro-4-methoxybenzyl)amino]-8-[(6-fluoropyridin-2-yl)methyl]amino]-3-(hydroxymethyl)quinoline-6-carbonitrile (9):**

Light yellow solid; yield 41% (15 mg, 31.4  $\mu$ mol);  $R_f$  (SiO<sub>2</sub>, ethanol/dichloromethane, 1/9, v/v): 0.40; Mp: 186 ± 1 °C; IR (cm<sup>-1</sup>)  $\nu$  3400 ( $\nu_{N-H}$ ), 2232 ( $\nu_{C\equiv N}$ ), 1550 ( $\delta_{N-H}$ ), 1504 ( $\delta_{N-H}$ ), 1436 ( $\delta_{CH_3}$ ), 1261 ( $\nu_{C-O}$ ), 1228 ( $\nu_{C-O}$ ); <sup>1</sup>H NMR (400 MHz, DMSO-d<sub>6</sub>)  $\delta$  8.40 (s, 1H, H<sub>2</sub>), 8.03 (m, 1H, H<sub>5</sub>), 7.93 (m, 1H, H<sub>10'</sub>), 7.55 (t, 1H, <sup>3</sup>J<sub>He-Hf</sub> = 6.2 Hz, H<sub>e</sub>), 7.38 (d, 1H, <sup>4</sup>J<sub>H2'-H6'</sub> = 2.1 Hz, H<sub>2'</sub>), 7.35 (t, 1H, <sup>3</sup>J<sub>Hb-Hc</sub> = 6.7 Hz, H<sub>b</sub>), 7.29 (m, 1H, H<sub>11'</sub>), 7.23 (dd, 1H, <sup>3</sup>J<sub>H6'-H5'</sub> = 8.6 Hz, <sup>4</sup>J<sub>H6'-H2'</sub> = 2.1 Hz, H<sub>6'</sub>), 7.10 (d,

1H,  $^3J_{H5'-H6'} = 8.6$  Hz, H<sub>5'</sub>), 7.05 (m, 1H, H<sub>9'</sub>), 6.66 (d, 1H,  $^4J_{H7-H5} = 1.2$  Hz, H<sub>7</sub>), 5.40 (brs, 1H, OH), 4.80 (d, 2H,  $^3J_{Hc-Hb} = 6.7$  Hz, H<sub>c</sub>), 4.59 (d, 2H,  $^3J_{Hf-He} = 6.2$  Hz, H<sub>f</sub>), 4.45 (d, 2H,  $^3J_{Ha-OH} = 3.7$  Hz, H<sub>a</sub>), 3.81 (s, 3H, H<sub>d</sub>);  $^{13}C$  NMR (100 MHz, DMSO-*d*<sub>6</sub>)  $\delta$  162.6 (d,  $^1J_{C8'-F} = 235$  Hz, C<sub>8'</sub>), 158.0 (d,  $^3J_{C12'-F} = 13$  Hz, C<sub>12'</sub>), 153.4 (C<sub>4'</sub>), 152.8 (C<sub>2</sub>), 150.0 (C<sub>4</sub>), 145.0 (C<sub>8</sub>), 142.7 (d,  $^3J_{C10'-F} = 8$  Hz, C<sub>10'</sub>), 139.3 (C<sub>8a</sub>), 134.3 (C<sub>1'</sub>), 127.8 (C<sub>2'</sub>), 126.1 (C<sub>6'</sub>), 121.0 (C<sub>3'</sub>), 120.2 (CN), 119.2 (C<sub>4a</sub>), 118.9 (d,  $^4J_{C11'-F} = 3$  Hz, C<sub>11'</sub>), 116.1 (C<sub>3</sub>), 115.0 (C<sub>5</sub>), 112.9 (C<sub>5'</sub>), 107.6 (d,  $^2J_{C9'-F} = 37$  Hz, C<sub>9'</sub>), 107.3 (C<sub>6</sub>), 103.7 (C<sub>7</sub>), 59.8 (C<sub>a</sub>), 56.0 (C<sub>d</sub>), 47.4 (C<sub>c</sub>), 46.9 (C<sub>f</sub>); HRMS (ESI) *m/z* calculated for C<sub>25</sub>H<sub>22</sub><sup>35</sup>ClFN<sub>5</sub>O<sub>2</sub> [M+H]<sup>+</sup>: 478.1446, found C<sub>25</sub>H<sub>22</sub><sup>35</sup>ClFN<sub>5</sub>O<sub>2</sub> [M+H]<sup>+</sup>: 478.1437 (100%); C<sub>25</sub>H<sub>22</sub><sup>37</sup>ClFN<sub>5</sub>O<sub>2</sub> [M+H]<sup>+</sup>: 480.1476 (33%).

#### 4.1.2.15. Preparation of precursors for radiolabelling

##### 4.1.2.15.1. 8-Bromo-4-[(3-chloro-4-methoxybenzyl)amino]-3-(hydroxymethyl)quinoline-6-carbonitrile (**22**):

A 1.1 M solution of lithium tri-*tert*-butoxyaluminum hydride in tetrahydrofuran (5.70 mL, 6.27 mmol, 6.0 eq.) was added, under stirring and argon atmosphere, to a solution of **14** [**28**] (0.5 g, 1.05 mmol, 1.0 eq.) in anhydrous tetrahydrofuran (30 mL). The resulting mixture was stirred at 60 °C for 20 hours. After cooling to room temperature, water (20 mL) was added under stirring. The aqueous layer was extracted with ethyl acetate (3 × 30 mL) and dichloromethane (3 × 30 mL). These two organic layers were separately washed with brine (100 mL), then combined, dried over magnesium sulfate, filtered and concentrated under reduced pressure. The crude residue was purified by column chromatography (SiO<sub>2</sub>, ethanol/dichloromethane, 5/95, v/v) to give the desired product **22** (0.31 g, 0.72 mmol, 69%) as a white solid. R<sub>f</sub> (SiO<sub>2</sub>, ethanol/dichloromethane, 5/95, v/v): 0.41; Mp: 209 ± 1 °C; IR (cm<sup>-1</sup>)  $\nu$  3403 ( $\nu_{N-H}$ ), 2229 ( $\nu_{C\equiv N}$ ), 1505 ( $\delta_{N-H}$ ), 1261 ( $\nu_{C-O}$ ), 1015 ( $\nu_{C-O}$ );  $^1H$  NMR (400 MHz, DMSO-*d*<sub>6</sub>)  $\delta$  8.96 (d, 1H,  $^4J_{H5-H7} = 1.5$  Hz, H<sub>5</sub>), 8.53 (s, 1H, H<sub>2</sub>), 8.35 (d, 1H,  $^4J_{H7-H5} = 1.5$  Hz, H<sub>7</sub>), 7.67 (t, 1H,  $^3J_{NH-Hb} = 6.7$  Hz, NH), 7.40 (d, 1H,  $^4J_{H2'-H6'} = 2.1$  Hz, H<sub>2'</sub>), 7.24 (dd, 1H,  $^4J_{H6'-H2'} = 2.1$  Hz,  $^3J_{H6'-H5'} = 8.5$  Hz, H<sub>6'</sub>), 7.10 (d, 1H,  $^3J_{H5'-H6'} = 8.5$  Hz, H<sub>5'</sub>), 5.48 (t, 1H,  $^3J_{OH-Ha} = 5.2$  Hz, OH), 4.85 (d, 2H,  $^3J_{Hb-NH} = 6.7$  Hz, H<sub>b</sub>), 4.46 (d, 2H,  $^3J_{Ha-OH} = 5.2$  Hz, H<sub>a</sub>), 3.81 (s, 3H, H<sub>c</sub>);  $^{13}C$  NMR (100 MHz, DMSO-*d*<sub>6</sub>)  $\delta$  156.7 (C<sub>2</sub>), 153.5 (C<sub>4'</sub>), 150.3 (C<sub>4</sub>), 146.8 (C<sub>8a</sub>), 133.8 (C<sub>1'</sub>), 132.6 (C<sub>7</sub>), 129.7 (C<sub>5</sub>), 127.9 (C<sub>2'</sub>), 126.2 (C<sub>6'</sub>), 125.5 (C<sub>8</sub>), 121.1 (C<sub>3'</sub>), 120.4 (C<sub>4a</sub>), 118.1 (CN), 116.2 (C<sub>3</sub>), 113.0 (C<sub>5'</sub>), 106.7 (C<sub>6</sub>), 59.6 (C<sub>a</sub>), 56.1 (C<sub>c</sub>), 47.5 (C<sub>b</sub>); HRMS (ESI) *m/z* calculated for C<sub>19</sub>H<sub>16</sub><sup>35</sup>Cl<sup>79</sup>BrN<sub>3</sub>O<sub>2</sub> [M+H]<sup>+</sup>: 432.0114, found C<sub>19</sub>H<sub>16</sub><sup>35</sup>Cl<sup>79</sup>BrN<sub>3</sub>O<sub>2</sub> [M+H]<sup>+</sup>: 432.0105 (77%); C<sub>19</sub>H<sub>16</sub><sup>37</sup>Cl<sup>79</sup>BrN<sub>3</sub>O<sub>2</sub> [M+H]<sup>+</sup>: 434.0087 (100%); C<sub>19</sub>H<sub>16</sub><sup>37</sup>Cl<sup>81</sup>BrN<sub>3</sub>O<sub>2</sub> [M+H]<sup>+</sup>: 436.0092 (24%).

##### 4.1.2.15.2. 8-Bromo-4-[(3-chloro-4-methoxybenzyl)amino]-3-(((triisopropylsilyl)oxy)methyl)quinoline-6-carbonitrile (**23**):

Triisopropylsilyl chloride (74  $\mu$ L, 0.35 mmol, 1.5 eq.), triethylamine (64  $\mu$ L, 0.46 mmol, 2.0 eq.), *N,N*-4-dimethylaminopyridine (5.6 mg, 45.8  $\mu$ mol, 0.2 eq.) were added, under argon atmosphere and stirring, to a solution of **22** (0.10 g, 0.25 mmol, 1.0 eq.) in anhydrous *N,N*-dimethylformamide (10 mL). The resulting mixture was stirred at room temperature for 36

hours before addition of water (20 mL). The solution was extracted with ethyl acetate (3 × 30 mL) and the combined organic layers were washed with brine (3 × 50 mL), dried over anhydrous magnesium sulfate, filtered, and then concentrated under reduced pressure. The crude residue was purified by column chromatography (SiO<sub>2</sub>, gradient: cyclohexane to ethyl acetate/cyclohexane, 2/8, v/v) to give the desired product **23** (0.11 g, 0.19 mmol, 76%) as a white solid. R<sub>f</sub> (SiO<sub>2</sub>, ethyl acetate/cyclohexane, 2/8, v/v): 0.33; Mp: 124 ± 1 °C; IR (cm<sup>-1</sup>) ν 3281 (ν<sub>N-H</sub>), 2943 (ν<sub>as CH<sub>3</sub></sub>), 2864 (ν<sub>s CH<sub>3</sub></sub>), 2227 (ν<sub>C≡N</sub>), 1503 (δ<sub>N-H</sub>), 1256 (ν<sub>C-O</sub>), 1060 (ν<sub>C-O</sub>), 807 (ν<sub>C-Si</sub>); <sup>1</sup>H NMR (200 MHz, CDCl<sub>3</sub>) δ 8.57 (s, 1H, H<sub>2</sub>), 8.56 (s, 1H, H<sub>5</sub>), 8.04 (s, 1H, H<sub>7</sub>), 7.35 (d, 1H, <sup>4</sup>J<sub>H<sub>2</sub>'-H<sub>6</sub>'</sub> = 1.8 Hz, H<sub>2</sub>'), 7.17 (dd, 1H, <sup>3</sup>J<sub>H<sub>6</sub>'-H<sub>5</sub>'</sub> = 8.3 Hz, <sup>4</sup>J<sub>H<sub>6</sub>'-H<sub>2</sub>'</sub> = 1.8 Hz, H<sub>6</sub>'), 6.90 (d, 1H, <sup>3</sup>J<sub>H<sub>5</sub>'-H<sub>6</sub>'</sub> = 8.3 Hz, H<sub>5</sub>'), 6.59 (brs, 1H, NH), 4.81 (s, 2H, H<sub>a</sub>), 4.77 (d, 2H, <sup>3</sup>J<sub>H<sub>d</sub>-NH</sub> = 5.2 Hz, H<sub>d</sub>), 3.89 (s, 3H, H<sub>e</sub>), 1.06 (m, 3H, H<sub>b</sub>), 0.98 (s, 18H, H<sub>c</sub>); <sup>13</sup>C NMR (50 MHz, CDCl<sub>3</sub>) δ 155.1 (C<sub>4</sub>'), 153.5 (C<sub>4</sub>), 152.0 (C<sub>2</sub>), 147.9 (C<sub>8a</sub>), 133.1 (C<sub>7</sub>), 131.5 (C<sub>1</sub>'), 130.7 (C<sub>5</sub>), 129.4 (C<sub>2</sub>'), 127.0 (C<sub>6</sub>'), 125.8 (C<sub>8</sub>), 123.3 (C<sub>3</sub>'), 120.7 (C<sub>4a</sub>), 119.1 (C<sub>3</sub>), 117.9 (CN), 112.5 (C<sub>5</sub>'), 107.7 (C<sub>6</sub>), 63.2 (C<sub>a</sub>), 56.3 (C<sub>e</sub>), 52.1 (C<sub>d</sub>), 17.9 (6C, C<sub>c</sub>), 11.8 (3C, C<sub>b</sub>); HRMS (ESI) *m/z* calculated for C<sub>28</sub>H<sub>36</sub><sup>79</sup>Br<sup>35</sup>ClN<sub>3</sub>O<sub>2</sub>Si [M+H]<sup>+</sup>: 588.1449, found C<sub>28</sub>H<sub>36</sub><sup>79</sup>Br<sup>35</sup>ClN<sub>3</sub>O<sub>2</sub>Si [M+H]<sup>+</sup>: 588.1412 (77%); C<sub>28</sub>H<sub>36</sub><sup>79</sup>Br<sup>37</sup>ClN<sub>3</sub>O<sub>2</sub>Si [M+H]<sup>+</sup>: 590.1365 (100%); C<sub>28</sub>H<sub>36</sub><sup>81</sup>Br<sup>37</sup>ClN<sub>3</sub>O<sub>2</sub>Si [M+H]<sup>+</sup>: 592.1424 (24%).

#### 4.1.2.15.3. 4-[(3-Chloro-4-methoxybenzyl)amino]-8-(3-hydroxyazetidino-1-yl)-3-[[[(triisopropylsilyloxy)methyl]quinoline-6-carbonitrile (24):

A solution of *tert*-butyl 3-hydroxyazetidino-1-carboxylate (0.60 g, 3.46 mmol, 3.4 eq.) in anhydrous chloromethane (5.0 mL) was placed in a flask equipped with a screw cap and trifluoroacetic acid (2.5 mL) was added under argon atmosphere. The resulting mixture was stirred at room temperature for one hour and afterwards evaporated under vacuum for 3 hours. The residue was dissolved in anhydrous toluene (20 mL) under argon atmosphere and caesium carbonate (2.00 g, 6.14 mmol, 6.0 eq.) was added. After stirring at room temperature for 15 minutes, **23** (0.60 g, 1.02 mmol, 1.0 eq.), palladium(II) acetate (46 mg, 0.20 mmol, 0.2 eq.), and 2,2'-bis(diphenylphosphino)-1,1'-binaphthyl (BINAP) (127 mg, 0.20 mmol, 0.2 eq.) were added. The resulting mixture was refluxed for 3 hours. After cooling to room temperature, the reaction mixture was concentrated under reduced pressure and the crude residue was purified by column chromatography (SiO<sub>2</sub>, ethyl acetate/cyclohexane, 5/5, v/v) to give the desired product **24** (0.30 g, 0.52 mmol, 51%) as an orange solid. R<sub>f</sub> (SiO<sub>2</sub>, cyclohexane/ethyl acetate, 5/5, v/v): 0.29; Mp: 105 ± 1 °C; IR (cm<sup>-1</sup>) ν 2943 (ν<sub>as CH<sub>3</sub></sub>), 2865 (ν<sub>s CH<sub>3</sub></sub>), 2222 (ν<sub>C≡N</sub>), 1502 (δ<sub>N-H</sub>), 1436 (δ<sub>CH<sub>3</sub></sub>), 1257 (ν<sub>C-O</sub>), 1064 (ν<sub>C-O</sub>), 809 (ν<sub>C-Si</sub>), 683 (ν<sub>C-Cl</sub>); <sup>1</sup>H NMR (200 MHz, CDCl<sub>3</sub>) δ 8.35 (s, 1H, H<sub>2</sub>), 7.80 (d, 1H, <sup>4</sup>J<sub>H<sub>5</sub>-H<sub>7</sub></sub> = 1.4 Hz, H<sub>5</sub>), 7.34 (d, 1H, <sup>4</sup>J<sub>H<sub>2</sub>'-H<sub>6</sub>'</sub> = 2.1 Hz, H<sub>2</sub>'), 7.16 (dd, 1H, <sup>3</sup>J<sub>H<sub>6</sub>'-H<sub>5</sub>'</sub> = 8.4 Hz, <sup>4</sup>J<sub>H<sub>6</sub>'-H<sub>2</sub>'</sub> = 2.1 Hz, H<sub>6</sub>'), 6.89 (d, 1H, <sup>3</sup>J<sub>H<sub>5</sub>'-H<sub>6</sub>'</sub> = 8.4 Hz, H<sub>5</sub>'), 6.54 (d, 1H, <sup>4</sup>J<sub>H<sub>7</sub>-H<sub>5</sub></sub> = 1.5 Hz, H<sub>7</sub>), 6.07 (brs, 1H, NH), 4.76 (m, 3H, H<sub>a</sub>, H<sub>g</sub>), 4.67 (d, 2H, <sup>3</sup>J<sub>H<sub>d</sub>-NH</sub> = 5.7 Hz, H<sub>d</sub>), 4.57 (m, 2H, H<sub>f</sub>), 4.03 (m, 2H, H<sub>f</sub>), 3.90 (s, 3H, H<sub>e</sub>), 1.00 (m, 21H, H<sub>b</sub>, H<sub>c</sub>); <sup>13</sup>C NMR (50 MHz, CDCl<sub>3</sub>) δ 154.9 (C<sub>4</sub>'), 153.0 (C<sub>4</sub>), 148.8 (C<sub>8</sub>), 148.6 (C<sub>2</sub>), 143.0 (C<sub>8a</sub>), 132.4 (C<sub>1</sub>'), 129.6 (C<sub>2</sub>'), 127.1 (C<sub>6</sub>'), 123.0 (C<sub>3</sub>'), 121.1 (C<sub>4a</sub>), 120.0 (2C, CN, C<sub>3</sub>), 119.3 (C<sub>5</sub>), 112.4 (C<sub>5</sub>'), 109.2 (C<sub>7</sub>), 108.0 (C<sub>6</sub>), 64.3 (2C, C<sub>f</sub>, C<sub>f</sub>), 63.4 (C<sub>g</sub>), 63.2 (C<sub>a</sub>), 56.4 (C<sub>e</sub>), 52.2 (C<sub>d</sub>), 18.0 (6C, C<sub>c</sub>), 11.9 (3C, C<sub>b</sub>);

HRMS (ESI)  $m/z$  calculated for  $C_{31}H_{42}^{35}ClN_4O_3Si$   $[M+H]^+$ : 581.2709, found  $C_{31}H_{42}^{35}ClN_4O_3Si$   $[M+H]^+$ : 581.2711 (100%);  $C_{31}H_{42}^{37}ClN_4O_3Si$   $[M+H]^+$ : 583.2685 (33%).

#### 4.1.2.15.4 General procedure for 25 & 26:

4-Nitrobenzenesulfonyl chloride (3.0 eq.), triethylamine (0.29 mL, 2.08 mmol, 5.0 eq.), and DMAP (0.2 eq.) were added, under stirring and argon atmosphere, to a solution of **24** (1.0 eq.) in anhydrous dichloromethane (20 mL). The resulting mixture was stirred at room temperature for 19 hours before addition of water (60 mL). This mixture was extracted with ethyl acetate (3 x 60 mL). The combined organic layers were washed with brine (100 mL), dried over magnesium sulfate, filtered and concentrated under reduced pressure at room temperature. The crude residue was purified by column chromatography ( $SiO_2$ , ethyl acetate/cyclohexane, 2/8, v/v) to give the desired products.

##### 4.1.2.15.4.1. 1-[4-((3-Chloro-4-methoxybenzyl)amino)-6-cyano-3-(((triisopropylsilyl)oxy)methyl)quinolin-8-yl]azetid-3-yl-4-methylbenzenesulfonate (25):

Yellow solid; yield 72% (0.22 g, 0.30 mmol);  $R_f$  ( $SiO_2$ , ethyl acetate / cyclohexane, 5 / 5, v / v): 0.73; Mp:  $67 \pm 1$  °C; IR ( $cm^{-1}$ )  $\nu$  2942 ( $\nu_{as} CH_3$ ), 2864 ( $\nu_s CH_3$ ), 2224 ( $\nu_{C\equiv N}$ ), 1502 ( $\delta_{N-H}$ ), 1437 ( $\nu_{as} SO_2$ ), 1176 ( $\nu_s SO_2$ ), 1063 ( $\nu_{C-O}$ ), 812 ( $\nu_{C-Si}$ );  $^1H$  NMR (200 MHz,  $CDCl_3$ )  $\delta$  8.31 (s, 1H,  $H_2$ ), 7.82 (m, 3H,  $H_5$ ,  $H_8'$ ), 7.38 (m, 2H,  $H_9'$ ), 7.33 (d, 1H,  $^4J_{H_2'-H_6'} = 2.2$  Hz,  $H_2'$ ), 7.15 (dd, 1H,  $^3J_{H_6'-H_5'} = 8.4$  Hz,  $^4J_{H_6'-H_2'} = 2.2$  Hz,  $H_6'$ ), 6.89 (d, 1H,  $^3J_{H_5'-H_6'} = 8.4$  Hz,  $H_5'$ ), 6.46 (s, 1H,  $H_7$ ), 5.96 (brs, 1H, NH), 5.22 (m, 1H,  $H_g$ ), 4.74 (s, 2H,  $H_a$ ), 4.63 (m, 4H,  $H_d$ ,  $H_f$ ), 4.16 (m, 2H,  $H_f'$ ), 3.90 (s, 3H,  $H_e$ ), 2.48 (s, 3H,  $H_h$ ), 1.16 (m, 21H,  $H_b$ ,  $H_c$ );  $^{13}C$  NMR (50 MHz,  $CDCl_3$ )  $\delta$  154.9 ( $C_4'$ ), 152.9 ( $C_4$ ), 148.6 ( $C_2$ ), 147.9 ( $C_8$ ), 145.5 ( $C_{10}'$ ), 142.8 ( $C_{8a}$ ), 133.1 ( $C_7'$ ), 132.2 ( $C_1'$ ), 130.2 (2C,  $C_9'$ ), 129.5 ( $C_2'$ ), 128.0 (2C,  $C_8'$ ), 127.1 ( $C_6'$ ), 123.1 (2C,  $C_3'$ ,  $C_{4a}$ ), 120.1 ( $C_5$ ), 119.8 (CN), 119.2 ( $C_3$ ), 112.4 ( $C_5'$ ), 108.9 ( $C_7$ ), 107.9 ( $C_6$ ), 69.3 ( $C_g$ ), 63.1 ( $C_a$ ), 61.2 (2C,  $C_f$ ,  $C_f'$ ), 56.3 ( $C_e$ ), 52.1 ( $C_d$ ), 21.8 ( $C_h$ ), 17.9 (6C,  $C_c$ ), 11.8 (3C,  $C_b$ ); HRMS (ESI)  $m/z$  calculated for  $C_{38}H_{48}^{35}ClN_4O_5SSi$   $[M+H]^+$ : 735.2798, found  $C_{38}H_{48}^{35}ClN_4O_5SSi$   $[M+H]^+$ : 735.2798 (100%);  $C_{38}H_{48}^{37}ClN_4O_5SSi$   $[M+H]^+$ : 737.2780 (33%).

##### 4.1.2.15.4.2. 1-[4-((3-Chloro-4-methoxybenzyl)amino)-6-cyano-3-(((triisopropylsilyl)oxy)methyl)quinolin-8-yl]azetid-3-yl-4-nitrobenzenesulfonate (26):

Yellow solid; yield 78% (0.30 g, 0.39 mmol);  $R_f$  ( $SiO_2$ , ethyl acetate/cyclohexane, 3/7, v/v): 0.44; Mp:  $65 \pm 1$  °C; IR ( $cm^{-1}$ )  $\nu$  2970 ( $\nu_{as} CH_3$ ), 2901 ( $\nu_s CH_3$ ), 2232 ( $\nu_{C\equiv N}$ ), 1259 ( $\nu_{C-O}$ ), 1187 ( $\nu_{C-O}$ ), 1066 ( $\nu_{C-O}$ ), 810 ( $\nu_{C-Si}$ );  $^1H$  NMR (200 MHz,  $CDCl_3$ )  $\delta$  8.42 (m, 2H,  $H_9'$ ), 8.29 (s, 1H,  $H_2$ ), 8.14 (m, 2H,  $H_8'$ ), 7.83 (d, 1H,  $^4J_{H_5-H_7} = 1.3$  Hz,  $H_5$ ), 7.32 (d, 1H,  $^4J_{H_2'-H_6'} = 2.2$  Hz,  $H_2'$ ), 7.15 (dd, 1H,  $^3J_{H_6'-H_5'} = 8.4$  Hz,  $^4J_{H_6'-H_2'} = 2.2$  Hz,  $H_6'$ ), 6.88 (d, 1H,  $^3J_{H_5'-H_6'} = 8.4$  Hz,  $H_5'$ ), 6.47 (d, 1H,  $^4J_{H_7-H_5} = 1.3$  Hz,  $H_7$ ), 5.96 (brs, 1H, NH), 5.31 (m, 1H,  $H_g$ ), 4.73 (s, 2H,  $H_a$ ), 4.65 (m, 4H,  $H_d$ ,  $H_f$ ), 4.24 (m, 2H,  $H_f'$ ), 3.88 (s, 3H,  $H_e$ ), 0.99 (m, 21H,  $H_b$ ,  $H_c$ );  $^{13}C$  NMR (50 MHz,  $CDCl_3$ )  $\delta$  154.8 ( $C_4'$ ), 152.7 ( $C_4$ ), 151.0 ( $C_{10}'$ ), 149.1 ( $C_2$ ), 147.6 ( $C_8$ ), 143.0 ( $C_{8a}$ ), 141.9 ( $C_7'$ ), 132.2 ( $C_1'$ ), 129.4 ( $C_2'$ ), 129.3 (2C,  $C_9'$ ), 127.0 ( $C_6'$ ), 124.7 (2C,  $C_8'$ ), 123.0 ( $C_3'$ ), 121.0 ( $C_{4a}$ ), 120.3 ( $C_5$ ), 119.7 (CN), 119.2 ( $C_3$ ), 112.4 ( $C_5'$ ), 108.8 ( $C_7$ ), 107.7 ( $C_6$ ), 70.7 ( $C_g$ ), 63.1 ( $C_a$ ), 61.1 (2C,  $C_f$ ,  $C_f'$ ), 56.3 ( $C_e$ ), 52.0 ( $C_d$ ), 17.9 (6C,  $C_c$ ), 11.8 (3C,  $C_b$ ); HRMS (ESI)  $m/z$  calculated for  $C_{37}H_{45}^{35}ClN_5O_7SSi$   $[M+H]^+$ : 766.2492, found  $C_{37}H_{45}^{35}ClN_5O_7SSi$   $[M+H]^+$ : 766.2492 (100%);  $C_{37}H_{45}^{37}ClN_5O_7SSi$   $[M+H]^+$ : 768.2475 (33%).



#### 4.1.2.15.5. General procedure for 27 & 28:

A 1.0 M solution of tetra-*n*-butylammonium fluoride in tetrahydrofuran (0.39 mL, 0.39 mmol, 1.0 eq.) was added slowly at 0 °C, under stirring and argon atmosphere, to a solution of **25** or **26** (1.0 eq.) in anhydrous THF (20 mL). The resulting mixture was stirred at room temperature for 30 minutes before addition of water at 0 °C. The resulting solution was extracted with ethyl acetate (3 x 50 mL) and the combined organic layers were washed with brine (100 mL), dried over magnesium sulfate, filtered and concentrated under reduced pressure at room temperature. The crude residue was purified by column chromatography (SiO<sub>2</sub>, ethyl acetate/cyclohexane, 5/5, v/v) to give the desired product.

##### 4.1.2.15.5.1. 1-[4-((3-Chloro-4-methoxybenzyl)amino)-6-cyano-3-(hydroxymethyl)quinolin-8-yl]azetid-3-yl-4-methylbenzenesulfonate (**27**):

Light yellow solid; yield 70% (0.12 g, 0.21 mmol); *R<sub>f</sub>* (SiO<sub>2</sub>, methanol/dichloromethane, 3/7, v/v): 0.39; Mp: 155 ± 1 °C; IR (cm<sup>-1</sup>) ν 2226 (ν<sub>C≡N</sub>), 1502 (δ<sub>N-H</sub>), 1349 (ν<sub>as SO2</sub>), 1173 (ν<sub>s SO2</sub>), 1064 (ν<sub>C-O</sub>), 812 (ν<sub>C-Cl</sub>); <sup>1</sup>H NMR (200 MHz, CDCl<sub>3</sub>) δ 8.33 (s, 1H, H<sub>2</sub>), 7.83 (d, 2H, <sup>3</sup>J<sub>H8'-H9'</sub> = 8.4 Hz, H<sub>8'</sub>), 7.74 (d, 1H, <sup>4</sup>J<sub>H5-H7</sub> = 1.3 Hz, H<sub>5</sub>), 7.39 (d, 2H, <sup>3</sup>J<sub>H9'-H8'</sub> = 8.4 Hz, H<sub>9'</sub>), 7.32 (d, 1H, <sup>4</sup>J<sub>H2'-H6'</sub> = 2.2 Hz, H<sub>2'</sub>), 7.16 (dd, 1H, <sup>3</sup>J<sub>H6'-H5'</sub> = 8.4 Hz, <sup>4</sup>J<sub>H6'-H2'</sub> = 2.2 Hz, H<sub>6'</sub>), 6.91 (d, 1H, <sup>3</sup>J<sub>H5'-H6'</sub> = 8.4 Hz, H<sub>5'</sub>), 6.48 (d, 1H, <sup>4</sup>J<sub>H7-H5</sub> = 1.3 Hz, H<sub>7</sub>), 5.84 (brs, 1H, NH), 5.22 (m, 1H, H<sub>g</sub>), 4.68 (s, 4H, H<sub>a</sub>, H<sub>b</sub>), 4.59 (m, 2H, H<sub>d</sub>), 4.14 (m, 2H, H<sub>d'</sub>), 3.90 (s, 3H, H<sub>c</sub>), 2.49 (s, 3H, H<sub>h</sub>); <sup>13</sup>C NMR (50 MHz, CDCl<sub>3</sub>) δ 154.8 (C<sub>4'</sub>), 152.4 (C<sub>4</sub>), 149.8 (C<sub>2</sub>), 147.8 (C<sub>8</sub>), 145.6 (C<sub>10'</sub>), 142.5 (C<sub>8a</sub>), 133.1 (C<sub>7'</sub>), 132.1 (C<sub>1'</sub>), 130.2 (2C, C<sub>9'</sub>), 129.4 (C<sub>2'</sub>), 128.1 (2C, C<sub>8'</sub>), 126.9 (C<sub>6'</sub>), 122.9 (C<sub>3'</sub>), 120.9 (C<sub>4a</sub>), 119.7 (CN), 119.3 (C<sub>5</sub>), 118.5 (C<sub>3</sub>), 112.5 (C<sub>5'</sub>), 109.2 (C<sub>7</sub>), 108.1 (C<sub>6</sub>), 69.3 (C<sub>e</sub>), 61.9 (C<sub>a</sub>), 61.3 (2C, C<sub>d</sub>, C<sub>d'</sub>), 56.3 (C<sub>c</sub>), 51.8 (C<sub>b</sub>), 21.9 (C<sub>f</sub>); HRMS (ESI) *m/z* calculated for C<sub>29</sub>H<sub>28</sub><sup>35</sup>CIN<sub>4</sub>O<sub>5</sub>S [M+H]<sup>+</sup>: 579.1463, found C<sub>29</sub>H<sub>28</sub><sup>35</sup>CIN<sub>4</sub>O<sub>5</sub>S [M+H]<sup>+</sup>: 579.1473 (100%); C<sub>29</sub>H<sub>28</sub><sup>37</sup>CIN<sub>4</sub>O<sub>5</sub>S [M+H]<sup>+</sup>: 581.1436 (33%).

##### 4.1.2.15.5.2. 1-[4-((3-Chloro-4-methoxybenzyl)amino)-6-cyano-3-(hydroxymethyl)quinolin-8-yl]azetid-3-yl-4-nitrobenzenesulfonate (**28**):

Light yellow solid; yield 64% (0.15 g, 0.25 mmol); *R<sub>f</sub>* (SiO<sub>2</sub>, methanol/dichloromethane, 5/5, v/v): 0.21; Mp: 128 ± 1 °C; IR (cm<sup>-1</sup>) ν 2226 (ν<sub>C≡N</sub>), 1502 (δ<sub>NH</sub>), 1347 (ν<sub>as SO2</sub>), 1187 (ν<sub>s SO2</sub>), 1063 (ν<sub>C-O</sub>), 1014 (ν<sub>C-O</sub>); <sup>1</sup>H NMR (200 MHz, CDCl<sub>3</sub>) δ 8.42 (d, 2H, <sup>3</sup>J<sub>H9'-H8'</sub> = 8.4 Hz, H<sub>9'</sub>), 8.28 (s, 1H, H<sub>2</sub>), 8.14 (d, 1H, <sup>3</sup>J<sub>H8'-H9'</sub> = 8.4 Hz, H<sub>8'</sub>), 7.72 (s, 1H, H<sub>5</sub>), 7.30 (d, 1H, <sup>4</sup>J<sub>H2'-H6'</sub> = 2.1 Hz, H<sub>2'</sub>), 7.15 (dd, 1H, <sup>3</sup>J<sub>H6'-H5'</sub> = 8.5 Hz, <sup>4</sup>J<sub>H6'-H2'</sub> = 2.1 Hz, H<sub>6'</sub>), 6.89 (d, 1H, <sup>3</sup>J<sub>H5'-H6'</sub> = 8.5 Hz, H<sub>5'</sub>), 6.46 (s, 1H, H<sub>7</sub>), 5.81 (se, 1H, NH), 5.30 (m, 1H, H<sub>g</sub>), 4.66 (m, 4H, H<sub>a</sub>, H<sub>b</sub>), 4.59 (m, 2H, H<sub>d</sub>), 4.20 (m, 2H, H<sub>d'</sub>), 3.89 (s, 3H, H<sub>c</sub>); <sup>13</sup>C NMR (50 MHz, CDCl<sub>3</sub>) δ 154.9 (C<sub>4'</sub>), 152.5 (C<sub>4</sub>), 151.1 (C<sub>10'</sub>), 149.9 (C<sub>2</sub>), 147.4 (C<sub>8</sub>), 142.3 (C<sub>8a</sub>), 141.8 (C<sub>7'</sub>), 132.0 (C<sub>1'</sub>), 129.4 (2C, C<sub>8'</sub>), 129.3 (C<sub>2'</sub>), 126.9 (C<sub>6'</sub>), 124.8 (2C, C<sub>9'</sub>), 123.0 (C<sub>3'</sub>), 120.8 (C<sub>4a</sub>), 119.7 (C<sub>5</sub>), 119.6 (CN), 118.4 (C<sub>3</sub>), 112.5 (C<sub>5'</sub>), 109.5 (C<sub>7</sub>), 108.1 (C<sub>6</sub>), 70.7 (C<sub>e</sub>), 61.9 (C<sub>a</sub>), 61.2 (2C, C<sub>d</sub>, C<sub>d'</sub>), 56.4 (C<sub>c</sub>), 51.8 (C<sub>b</sub>); HRMS (ESI) *m/z* calculated for C<sub>28</sub>H<sub>25</sub><sup>35</sup>CIN<sub>5</sub>O<sub>7</sub>S [M+H]<sup>+</sup>: 610.1158, found C<sub>28</sub>H<sub>25</sub><sup>35</sup>CIN<sub>5</sub>O<sub>7</sub>S [M+H]<sup>+</sup>: 610.1161 (100%); C<sub>28</sub>H<sub>25</sub><sup>37</sup>CIN<sub>5</sub>O<sub>7</sub>S [M+H]<sup>+</sup>: 612.1132 (33%).

## 4.2 Radiochemistry

#### 4.2.1. General

No-carrier-added [ $^{18}\text{F}$ ]fluoride was produced via the [ $^{18}\text{O}(\text{p},\text{n})^{18}\text{F}$ ] nuclear reaction by irradiation of an [ $^{18}\text{O}$ ]H $_2$ O target (Hyox 18 enriched water, Rotem Industries Ltd, Israel) on a Cyclone 18/9 (iba RadioPharma Solutions, Belgium) with fixed energy proton beam using Nirta [ $^{18}\text{F}$ ]fluoride XL target.

Radio thin layer chromatography (radio-TLC) was performed on silica gel (Polygram<sup>®</sup> SIL G/UV $_{254}$ ) pre-coated plates with a mixture of ethyl acetate/*n*-hexane 4/1 (v/v) as eluent. The plates were exposed to storage phosphor screens (BAS-IP MS 2025, FUJIFILM Co., Tokyo, Japan) and recorded using the Amersham Typhoon RGB Biomolecular Imager (GE Healthcare Life Sciences). Images were quantified with the ImageQuant TL8.1 software (GE Healthcare Life Sciences).

Analytical chromatographic separations were performed on a JASCO LC-2000 system, incorporating a PU-2080*Plus* pump, AS-2055*Plus* auto injector (100  $\mu\text{L}$  sample loop), and a UV-2070*Plus* detector coupled with a gamma radioactivity HPLC detector (Gabi Star, raytest Isotopenmessgeräte GmbH). Data analysis was performed with the Galaxie chromatography software (Agilent Technologies) using the chromatograms obtained at 254 nm. A Reprosil-Pur C18-AQ column (250 x 4.6 mm; 5  $\mu\text{m}$ ; Dr. Maisch HPLC GmbH; Germany) with ACN/20 mM NH $_4$ OAc aq. (pH 6.8) as eluent mixture and a flow of 1.0 mL/min was used (gradient: eluent A 10% ACN/20 mM NH $_4$ OAc aq.; eluent B 90% ACN/20 mM NH $_4$ OAc aq.; 0–10 min 100% A, 10–30 min up to 100% B, 30–35 min 100% B, 35–37 min up to 100% A, 37–45 min 100% A).

The ammonium acetate and sodium dodecyl sulfate (SDS) concentrations stated as 20 mM NH $_4$ OAc aq. and 100 mM aq., respectively, correspond to the concentration in the aqueous component of an eluent mixture.

The molar activities were determined on the basis of a calibration curve carried out under isocratic HPLC conditions (50% ACN/20 mM NH $_4$ OAc $_{\text{aq}}$ ; Reprosil-Pur C18-AQ, 250 x 4.6 mm) using chromatograms obtained at 254 nm.

#### 4.2.2. Radiosyntheses

##### 4.2.2.1. Manual syntheses with tosylate **27** as precursor

No carrier added [ $^{18}\text{F}$ ]fluoride in 1.5 mL of water was trapped on a Chromafix<sup>®</sup> 30 PS-HCO $_3^-$  cartridge (ABX, Radeberg, Germany). The activity was eluted with 300  $\mu\text{L}$  of an aqueous solution of potassium carbonate (K $_2$ CO $_3$ , 1.8 mg, 13  $\mu\text{mol}$ ) into a 4 mL V-vial and Kryptofix 2.2.2 (K $_{2.2.2}$ , 11 mg, 29  $\mu\text{mol}$ ) in 1 mL of ACN was added. The aqueous [ $^{18}\text{F}$ ]fluoride was azeotropically dried under vacuum and nitrogen flow within 7-10 min using a single mode microwave (75 W, at 50–60  $^\circ\text{C}$ , power cycling mode; Discover PETWave from CEM corporation, USA). Two aliquots of ACN (2 x 1.0 mL) were added during the drying procedure and the final complex was dissolved in 1.0 mL of labeling solvent and divided in two portions. Accordingly, most of the labeling reactions were performed with half of the K[ $^{18}\text{F}$ ]F/K $_{222}$  complex. Thereafter, a solution of 2.0 - 2.5 mg of precursor **27** in 500  $\mu\text{L}$  of the appropriate solvent was added, and  $^{18}\text{F}$ -labeling was performed at different temperatures in dependence of the solvent used (90, 100, 120, 130 and 150  $^\circ\text{C}$ ). To analyze the reaction mixture and to determine radiochemical

yields, samples were taken for radio-HPLC and radio-TLC at different time points (5, 10, 15, 20 and 25 min).

#### 4.2.2.2. Automated syntheses with tosylate **27** as precursor

Remote controlled radiosynthesis of [ $^{18}\text{F}$ ]**7** was performed using a TRACERlab FX2 N synthesizer (GE Healthcare, USA) equipped with a Laboport vacuum pump N810.3FT.18 (KNF Neuburger GmbH, Freiburg, Germany), a BlueShadow UV detector 10D (KNAUER GmbH, Berlin, Germany) and the TRACERlab FX Software.

[ $^{18}\text{F}$ ]Fluoride (4 – 5 GBq) was trapped on a Chromafix<sup>®</sup> 30 PS-HCO<sub>3</sub><sup>-</sup> cartridge (Figure 4, entry **1**, ABX, Radeberg, Germany) and eluted into the reactor with 400  $\mu\text{L}$  of an aqueous solution of potassium carbonate (K<sub>2</sub>CO<sub>3</sub>, 1.8 mg, 13  $\mu\text{mol}$ , entry **2**). After adding Kryptofix 2.2.2. in 1 mL of ACN (11 mg, 29  $\mu\text{mol}$ , entry **3**), the mixture was azeotropically dried for approximately 10 minutes. Thereafter, 2.0 - 2.5 mg of the tosylate precursor **27** dissolved in 1 mL of DMSO (entry **4**) was added, and the reaction mixture was stirred at 100 °C for 15 min. After cooling, the reaction mixture was diluted with 2.0 mL of H<sub>2</sub>O and 1.0 mL of ACN (entry **5**) and transferred into the injection vial (entry **6**). Semi-preparative HPLC was performed using a Reprosil-Pur C18-AQ column (250 x 10 mm; 10  $\mu\text{m}$ ; Dr. Maisch HPLC GmbH, Germany) with a solvent composition of 55% ACN/40 mM NH<sub>4</sub>OAc<sub>aq.</sub> at a flow rate of 3.5 mL/min (entry **7**). [ $^{18}\text{F}$ ]**7** was collected in the dilution vessel (entry **8**) previously loaded with 40 mL of H<sub>2</sub>O. Final purification was performed by passing the solution through a Sep-Pak<sup>®</sup> C18 light cartridge (entry **9**), followed by washing with 2 mL of water (entry **10**) and elution of [ $^{18}\text{F}$ ]**7** with 1.2 mL of EtOH (entry **11**) into the product vial (entry **12**). The ethanolic solution was transferred in a neighboring hotcell by remote control and the solvent manually reduced under a gentle argon stream at 75 °C to a final volume of 10-50  $\mu\text{L}$ . Afterwards the radiotracer was diluted in isotonic saline to obtain a final product containing 10% of EtOH (v/v).

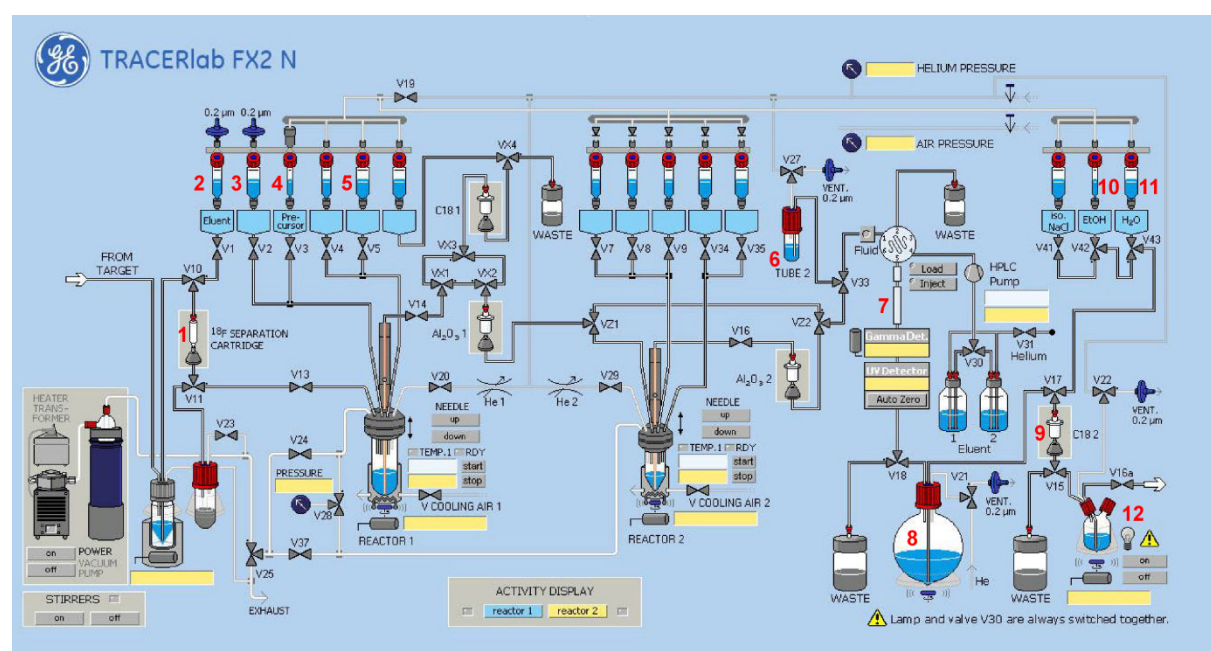

**Figure 4.** Scheme of the synthesis module TRACERlab FX2 N for the radiosynthesis of [ $^{18}\text{F}$ ]7.

**Tosylate 27 as precursor:** (1) Chromafix 30-PS- $\text{HCO}_3^-$ , (2)  $\text{K}_2\text{CO}_3$  (1.8 mg in 400  $\mu\text{L}$  water), (3)  $\text{K}_{2.2.2}$  (11 mg in 1 mL ACN), (4) precursor (2 mg of **27** in 1 mL DMSO), (5) 2.0 mL water and 1.0 mL ACN, (6) injection vial, (7) Reprosil-Pur C18-AQ (55% ACN/40 mM  $\text{NH}_4\text{OAc}_{\text{aq}}$ , flow 3.5 mL/min), (8) 40 mL water, (9) Sep-Pak<sup>®</sup> C18 light, (10) 2 mL water, (11) 1.2 mL EtOH, (12) product vial.

**Nosylate 28 as precursor:** (1) Sep-Pak<sup>®</sup> Accell QMA light cartridge, (2) 150  $\mu\text{L}$   $\text{TBAHCO}_3$  in 300  $\mu\text{L}$  water and 650  $\mu\text{L}$  ACN, (3) 2 mL ACN, (4) precursor (2 mg of **28** in 200  $\mu\text{L}$  ACN + 700  $\mu\text{L}$  3M3P + 80  $\mu\text{L}$  water), (5) 2.0 mL water + 2.0 mL ACN, (6) injection vial, (7) Reprosil-Pur C18-AQ (55% ACN/40 mM  $\text{NH}_4\text{OAc}_{\text{aq}}$ , flow 2.8 mL/min), (8) 40 mL water, (9) Sep-Pak<sup>®</sup> C18 light, (10) 2 mL water, (11) 1.2 mL EtOH, (12) product vial.

#### 4.2.2.3. Manual syntheses with nosylate 28 as precursor

No carrier added [ $^{18}\text{F}$ ]fluoride in 1.5 mL of water was trapped on a Chromafix<sup>®</sup> 30 PS- $\text{HCO}_3^-$  cartridge (ABX GmbH, Radeberg, Germany). The activity was eluted with 300  $\mu\text{L}$  of an aqueous solution of potassium carbonate ( $\text{K}_2\text{CO}_3$ , 1.8 mg, 13  $\mu\text{mol}$ ) into a 4 mL V-vial and Kryptofix 2.2.2 ( $\text{K}_{2.2.2}$ , 11 mg, 29  $\mu\text{mol}$ ) in 1 mL of ACN was added. For investigations of the precursor to base ratio, the amount of potassium carbonate was accordingly reduced or increased. For labeling with [ $^{18}\text{F}$ ]TBAF, the *tetra*-*n*-butylammonium hydrogen carbonate ( $\text{TBAHCO}_3$ ) solution (0.075 M, ABX, Radeberg, Germany) was directly placed into the V-vial containing [ $^{18}\text{F}$ ]fluoride and 1 mL of ACN. The aqueous [ $^{18}\text{F}$ ]fluoride was then azeotropically dried under vacuum and nitrogen flow within 7-10 min using a single mode microwave (75 W, at 50–60  $^\circ\text{C}$ , power cycling mode). Two aliquots of ACN (2 x 1.0 mL) were added during the drying procedure and the final complex was dissolved in an appropriate volume of labeling solvent and used directly or divided in several portions. Thereafter, a solution of 2.0 – 2.5 mg of precursor **28** in 300 – 500  $\mu\text{L}$  of an appropriate solvent was added, and  $^{18}\text{F}$ -labeling was performed at different temperatures in dependence of the solvent used (90, 100, 120, 130 and 150  $^\circ\text{C}$ ). To analyze the reaction mixture and to determine radiochemical yields, samples were taken for radio-HPLC and radio-TLC at different time points (5, 10, 15, 20 and 25 min).

#### 4.2.2.4. Automated syntheses with nosylate 28 as precursor

Remote controlled radiosynthesis of [ $^{18}\text{F}$ ]7 was performed using a TRACERlab FX2 N synthesizer (GE Healthcare, USA) equipped with a Laboport vacuum pump N810.3FT.18 (KNF Neuberger GmbH, Freiburg, Germany), a BlueShadow UV detector 10D (KNAUER GmbH, Berlin, Germany) and the TRACERlab FX Software.

[ $^{18}\text{F}$ ]Fluoride (4 – 5 GBq) was trapped on a Sep-Pak<sup>®</sup> Accell QMA light cartridge (Figure 5, entry **1**, Waters, USA) and eluted into the reactor with a solution of 150  $\mu\text{L}$  of  $\text{TBAHCO}_3$  (entry **2**, 0.075 M, ABX GmbH, Radeberg, Germany), 300  $\mu\text{L}$  of water and 650  $\mu\text{L}$  of ACN. After azeotropic drying at 50  $^\circ\text{C}$  for 3 min, 2 mL ACN (entry **3**) were added and azeotropic drying was continued for further 3 min at 70  $^\circ\text{C}$  and 1 min at 40  $^\circ\text{C}$ . Thereafter, 2.0–2.5 mg of the nosylate precursor (**28**) dissolved in a mixture of 200  $\mu\text{L}$  ACN / 700  $\mu\text{L}$  3M3P / 80  $\mu\text{L}$  water (entry **4**) was added, and the reaction mixture was stirred at 125  $^\circ\text{C}$  for 10 min. After cooling to 40  $^\circ\text{C}$ , the solvent was evaporated under vacuum and helium stream for 7 min, the residue was diluted with 2.0 mL of  $\text{H}_2\text{O}$  and 2.0 mL of ACN (entry **5**) and transferred into the injection vial (entry **6**). Semi-preparative HPLC was performed using a Reprosil-Pur C18-AQ column (250 x 10 mm;

10 µm; Dr. Maisch HPLC GmbH; Germany) with a solvent composition of 55% ACN/40 mM NH<sub>4</sub>OAc<sub>aq</sub> at a flow rate of 2.8 mL/min (entry 7). [<sup>18</sup>F]7 was collected in the dilution vessel (entry 8) previously loaded with 40 mL of H<sub>2</sub>O. Final purification was performed by passing the solution through a Sep-Pak<sup>®</sup> C18 light cartridge (entry 9), followed by washing with 2 mL of water (entry 10) and elution of [<sup>18</sup>F]7 with 1.2 mL of EtOH (entry 11) into the product vial (entry 12). The ethanolic solution was transferred in a neighboring hotcell by remote control and the solvent manually reduced under a gentle argon stream at 75 °C to a final volume of 10-50 µL. Afterwards the radiotracer was diluted in isotonic saline to obtain a final product containing 10% of EtOH (v/v).

#### 4.2.2.5. In vitro stability

The in vitro stability of [<sup>18</sup>F]7 was investigated by incubation of small tracer amounts (~ 5 MBq) at 40 °C in 500 µL of phosphate buffered saline and 500 µL of pig plasma samples. After 30 and 60 minutes, aliquots were taken and analyzed by radio-TLC and radio-HPLC.

#### 4.3. In vitro autoradiographic studies of [<sup>18</sup>F]7

Brain sections (20 µm) of flash-frozen brains of female domestic pigs (*Sus s. domestica*, 6 weeks, 12–14 kg) were cut using a cryostat, thaw-mounted onto microscope slides, and after air-drying stored at –80 °C until use. Briefly, the brain sections were allowed to thaw in air, and pre-incubated once in 50 mM TRIS buffer (pH 7.4) to remove endogenous ligand. The sections were then incubated with 2.02 ± 0.75 nM of [<sup>18</sup>F]7 in TRIS buffer (50 mM TRIS-HCl, 120 mM NaCl, 5 mM KCl, 2 mM MgCl<sub>2</sub>, 2 mM CaCl<sub>2</sub>, 0.1% BSA pH 7.4) for 60 minutes at room temperature. Nonspecific binding was determined in the presence of 1 µM 7. Displacement of [<sup>18</sup>F]7 was also evaluated with 1 µM sildenafil. Subsequently, the sections were washed twice for 2 minutes in ice-cold TRIS buffer, and dipped for 5 seconds in ice-cold distilled water. The sections were rapidly dried in a stream of cold air before being exposed to an imaging plate. Developed autoradiographs were analysed in a phosphor imager (Fuji BAS 1800 II). The quantification was performed by using 2D-densitometric analysis (AIDA 2.31 software; raytest Isotopenmessgeräte GmbH, Germany).

#### 4.4. In vivo studies of [<sup>18</sup>F]7 in mice

All animal studies followed the international guidelines of animal care and the study protocols were approved by the Landesdirektion Leipzig, the local authority for animal care (Reg.-Nr.: TVV 08/13; Reference number: 24-9168.11/18/8). All animal experiments were performed with female CD-1 mice, 10-12 weeks old, obtained from the Experimental Centre of the Faculty of Medicine (MEZ) at the Leipzig University, Leipzig, Germany.

##### 4.4.1 Organ uptake

[<sup>18</sup>F]7 obtained as described in 4.2.2.4. was dissolved in 200 µL of sterile isotonic saline and administered as a bolus injection via the tail vein of the restrained animal. At 5 (n=1; dose: 0.61 MBq) and 30 minutes p.i. (n=2; dose: 38 and 49 MBq), retro-orbital blood samples were obtained from the anesthetized animals. Immediately afterwards, organs of interest were

isolated and blood plasma was obtained by centrifugation of the whole blood sample (15000 rpm, room temperature, 1 minute). All samples were weighed and the radioactivity (in CPM) was measured in a gamma-counter (Wizard 2480, PerkinElmer LAS GmbH, Germany). For conversion of CPM values to Bq, standard samples were measured in a dose calibrator (ISOMED 2010, MED Nuklear-Medizintechnik Dresden GmbH, Dresden, Germany) as well as by gamma-counting. For each sample, the percentage of the injected dose was calculated and normalized according to the tissue weight (% ID/g<sub>tissue</sub>), followed by normalization according to the injected dose and the weight of the animal [(% ID/g<sub>tissue</sub>)/(100 %/g<sub>animal</sub>)] to calculate the standardized uptake value (SUV) for each tissue.

#### 4.4.2. Metabolism studies

Mouse blood samples were taken at 30 minutes after intravenous injection of ~40 MBq of [<sup>18</sup>F]7 (n = 2). Plasma was obtained by centrifugation of blood at 12,000 rpm at room temperature for 1 minute.

MLC: For preparation of the MLC injection samples, mouse plasma (20 – 50 µL, 30 minutes p.i.) was dissolved in 100 – 300 µL of 100 mM aqueous sodium dodecyl sulfate (SDS). Homogenized brain material (200 µL, 30 minutes p.i.) was dissolved in 400 µL of 200 mM aqueous SDS, stirred at 75 °C for 5 minutes, diluted with more 200 µL of 200 mM aqueous SDS and injected into the MLC system after cooling to room temperature. To proof the integrity of the radioligand under these conditions, 50 kBq of the radioligand were stirred at 75 °C for 5 minutes in 500 µL of 200 mM aqueous SDS and analysed via MLC. The MLC system was built up of a JASCO PU-980 pump, an AS-2055*Plus* auto injector with a 2000 µL sample loop, and a UV-1575 detector coupled with a gamma radioactivity HPLC detector (Gabi Star, raytest Isotopenmessgeräte GmbH). Data analysis was performed with the Galaxie chromatography software (Agilent Technologies). A Reprosil-Pur C18-AQ column (250 x 4.6 mm, particle size: 10 µm) coupled with a pre-column of 10 mm length was used. Separations were performed by using an eluent mixture of THF/100 mM aqueous SDS/10 mM Na<sub>2</sub>HPO<sub>4</sub> aq. in gradient mode (0 – 10 min at 5% THF, 10 – 25 min up to 50% THF, 25 – 30 min at 50% THF, 30 – 31 min up to 5% THF; 31 – 40 min at 5% THF/100 mM SDS aq., 10 mM Na<sub>2</sub>HPO<sub>4</sub> aq.) at a flow rate of 1.0 mL/min.

RP-HPLC: For protein precipitation and extraction an ice-cold mixture of acetone/water (9/1; v/v) was used in a ratio of 4 : 1 of solvent to plasma or brain homogenate, respectively. The samples were vortexed for 2 minutes, equilibrated on ice for 10 minutes, and centrifuged for 5 minutes at 10,000 rpm. After separating the supernatant, the precipitates were washed with 200 µL of the solvent mixture and subjected to the same procedure. The combined supernatants (total volume between 1.0 –1.5 mL) were concentrated at 65 °C under nitrogen flow to a final volume of approximately 100 µL and analyzed by analytical radio-HPLC. To determine the percentage of radioactivity in the supernatants compared to total activity, aliquots of each step as well as the precipitates were quantified by γ counting (PerkinElmer Wallac Wizard 1480 Gamma Counter, manufactured by WALLAC, Turku, Finland). With this procedure, recoveries of about 97% for the plasma and brain homogenates could be obtained.

To analyse the worked-up samples, the same HPLC method was used as described in the radiochemistry part.

## Acknowledgements

The authors would like to thank the China Scholarship Council for supporting the PhD thesis of Dr. Jianrong Liu. Campus France together with the German Academic Exchange Service – DAAD kindly supported this project with a travel grant (PHC PROCOPE Project ID: 57129895). The Region Auvergne-Rhone-Alpes supported the contribution of Dr. Jianrong Liu on an international conference. We also thank Dr. K. Franke, Dr. A. Mansel and Dr. S. Fischer for providing [<sup>18</sup>F]fluoride.

## References

- [1] C.A. Peixoto, A.K. Nunes, A. Garcia-Osta, Phosphodiesterase-5 inhibitors: action on the signaling pathways of neuroinflammation, neurodegeneration, and cognition, *Mediators Inflamm.*, 2015 (2015) 940207.
- [2] T. Peng, J. Gong, Y. Jin, Y. Zhou, R. Tong, X. Wei, L. Bai, J. Shi, Inhibitors of phosphodiesterase as cancer therapeutics, *Eur. J. Med. Chem.*, 150 (2018) 742-756.
- [3] M. Kumazoe, K. Sugihara, S. Tsukamoto, Y. Huang, Y. Tsurudome, T. Suzuki, Y. Suemasu, N. Ueda, S. Yamashita, Y. Kim, K. Yamada, H. Tachibana, 67-kDa laminin receptor increases cGMP to induce cancer-selective apoptosis, *J. Clin. Invest.*, 123 (2013) 787-799.
- [4] A. Das, D. Durrant, F.N. Salloum, L. Xi, R.C. Kukreja, PDE5 inhibitors as therapeutics for heart disease, diabetes and cancer, *Pharmacol. Ther.*, 147 (2015) 12-21.
- [5] C.M. Whitehead, K.A. Earle, J. Fetter, S. Xu, T. Hartman, D.C. Chan, T.L. Zhao, G. Piazza, A.J. Klein-Szanto, R. Pamukcu, H. Alila, P.A. Bunn, Jr., W.J. Thompson, Exisulind-induced apoptosis in a non-small cell lung cancer orthotopic lung tumor model augments docetaxel treatment and contributes to increased survival, *Mol. Cancer Ther.*, 2 (2003) 479-488.
- [6] G.A. Piazza, W.J. Thompson, R. Pamukcu, H.W. Alila, C.M. Whitehead, L. Liu, J.R. Fetter, W.E. Gresh, Jr., A.J. Klein-Szanto, D.R. Farnell, I. Eto, C.J. Grubbs, Exisulind, a novel proapoptotic drug, inhibits rat urinary bladder tumorigenesis, *Cancer Res.*, 61 (2001) 3961-3968.
- [7] F. Karami-Tehrani, M. Moeinifard, M. Aghaei, M. Atri, Evaluation of PDE5 and PDE9 expression in benign and malignant breast tumors, *Arch. Med. Res.*, 43 (2012) 470-475.
- [8] A.K. Joe, H. Liu, D. Xiao, J.W. Soh, J.T. Pinto, D.G. Beer, G.A. Piazza, W.J. Thompson, I.B. Weinstein, Exisulind and CP248 induce growth inhibition and apoptosis in human esophageal adenocarcinoma and squamous carcinoma cells, *J. Exp. Ther. Oncol.*, 3 (2003) 83-94.
- [9] M. Sponziello, A. Verrienti, F. Rosignolo, R.F. De Rose, V. Pecce, V. Maggisano, C. Durante, S. Bulotta, G. Damante, L. Giacomelli, C.R. Di Gioia, S. Filetti, D. Russo, M. Celano, PDE5 expression in human thyroid tumors and effects of PDE5 inhibitors on growth and migration of cancer cells, *Endocrine*, 50 (2015) 434-441.
- [10] B. Zhu, L. Vemavarapu, W.J. Thompson, S.J. Strada, Suppression of cyclic GMP-specific phosphodiesterase 5 promotes apoptosis and inhibits growth in HT29 cells, *J. Cell Biochem.*, 94 (2005) 336-350.
- [11] W.J. Thompson, G.A. Piazza, H. Li, L. Liu, J. Fetter, B. Zhu, G. Sperl, D. Ahnen, R. Pamukcu, Exisulind induction of apoptosis involves guanosine 3',5'-cyclic monophosphate

phosphodiesterase inhibition, protein kinase G activation, and attenuated beta-catenin, *Cancer Res.*, 60 (2000) 3338-3342.

[12] T.C. Peak, A. Richman, S. Gur, F.A. Yafi, W.J. Hellstrom, The Role of PDE5 Inhibitors and the NO/cGMP Pathway in Cancer, *Sex. Med. Rev.*, 4 (2016) 74-84.

[13] J.L. Roberts, L. Booth, A. Conley, N. Cruickshanks, M. Malkin, R.C. Kukreja, S. Grant, A. Poklepovic, P. Dent, PDE5 inhibitors enhance the lethality of standard of care chemotherapy in pediatric CNS tumor cells, *Cancer Biol. Ther.*, 15 (2014) 758-767.

[14] L. Booth, J.L. Roberts, N. Cruickshanks, S. Tavallai, T. Webb, P. Samuel, A. Conley, B. Binion, H.F. Young, A. Poklepovic, S. Spiegel, P. Dent, PDE5 inhibitors enhance celecoxib killing in multiple tumor types, *J. Cell. Physiol.*, 230 (2015) 1115-1127.

[15] L. Booth, J.L. Roberts, A. Poklepovic, P. Dent, PDE5 inhibitors enhance the lethality of [pemetrexed + sorafenib], *Oncotarget*, 8 (2017) 13464-13475.

[16] P.R. Ding, A.K. Tiwari, S. Ohnuma, J.W. Lee, X. An, C.L. Dai, Q.S. Lu, S. Singh, D.H. Yang, T.T. Talele, S.V. Ambudkar, Z.S. Chen, The phosphodiesterase-5 inhibitor vardenafil is a potent inhibitor of ABCB1/P-glycoprotein transporter, *PLoS One*, 6 (2011) e19329.

[17] Z. Shi, A.K. Tiwari, S. Shukla, R.W. Robey, S. Singh, I.W. Kim, S.E. Bates, X. Peng, I. Abraham, S.V. Ambudkar, T.T. Talele, L.W. Fu, Z.S. Chen, Sildenafil reverses ABCB1- and ABCG2-mediated chemotherapeutic drug resistance, *Cancer Res.*, 71 (2011) 3029-3041.

[18] G. Ribaudo, M.A. Pagano, S. Bova, G. Zagotto, New Therapeutic Applications of Phosphodiesterase 5 Inhibitors (PDE5-Is), *Curr. Med. Chem.*, 23 (2016) 1239-1249.

[19] D.G. Cooper, I.T. Forbes, V. Garzya, D.J. Johnson, G.I. Stevenson, P.A. Wyman, Preparation of cyclohexylpiperidinylbenzoxazolone derivatives and analogs as M1 receptor modulators., WO 2009037294A1, (2009).

[20] S. Schröder, B. Wenzel, W. Deuther-Conrad, M. Scheunemann, P. Brust, Novel Radioligands for Cyclic Nucleotide Phosphodiesterase Imaging with Positron Emission Tomography: An Update on Developments Since 2012, *Molecules*, 21 (2016).

[21] S. Jakobsen, G.M. Kodahl, A.K. Olsen, P. Cumming, Synthesis, radiolabeling and in vivo evaluation of [<sup>11</sup>C]RAL-01, a potential phosphodiesterase 5 radioligand, *Nucl. Med. Biol.*, 33 (2006) 593-597.

[22] V. Gomez-Vallejo, A. Ugarte, C. Garcia-Barroso, M. Cuadrado-Tejedor, B. Szczupak, I.G. Dopeso-Reyes, J.L. Lanciego, A. Garcia-Osta, J. Llop, J. Oyarzabal, R. Franco, Pharmacokinetic investigation of sildenafil using positron emission tomography and determination of its effect on cerebrospinal fluid cGMP levels, *J. Neurochem.*, 136 (2016) 403-415.

[23] R. Chekol, O. Gheysens, J. Cleynhens, P. Pokreisz, G. Vanhoof, M. Ahamed, S. Janssens, A. Verbruggen, G. Bormans, Evaluation of PET radioligands for in vivo visualization of phosphodiesterase 5 (PDE5), *Nucl. Med. Biol.*, 41 (2014) 155-162.

[24] R. Chekol, O. Gheysens, M. Ahamed, J. Cleynhens, P. Pokreisz, G. Vanhoof, S. Janssens, A. Verbruggen, G. Bormans, Carbon-11 and Fluorine-18 Radiolabeled Pyridopyrazinone Derivatives for Positron Emission Tomography (PET) Imaging of Phosphodiesterase-5 (PDE5), *J. Med. Chem.*, 60 (2017) 486-496.

[25] Y. Bi, P. Stoy, L. Adam, B. He, J. Krupinski, D. Normandin, R. Pongrac, L. Seliger, A. Watson, J.E. Macor, Quinolines as extremely potent and selective PDE5 inhibitors as potential agents for treatment of erectile dysfunction, *Bioorg. Med. Chem. Lett.*, 14 (2004) 1577-1580.

[26] J. Fiorito, F. Saeed, H. Zhang, A. Staniszewski, Y. Feng, Y.I. Francis, S. Rao, D.M. Thakkar, S.X. Deng, D.W. Landry, O. Arancio, Synthesis of quinoline derivatives: discovery of a potent and selective phosphodiesterase 5 inhibitor for the treatment of Alzheimer's disease, *Eur. J. Med. Chem.*, 60 (2013) 285-294.

[27] S.J. Lee, Y. Konishi, D.T. Yu, T.A. Miskowski, C.M. Riviello, O.T. Macina, M.R. Frierson, K. Kondo, M. Sugitani, J.C. Sircar, K.M. Blazejewski, Discovery of potent cyclic GMP phosphodiesterase inhibitors. 2-Pyridyl- and 2-imidazolylquinazolines possessing cyclic



- GMP phosphodiesterase and thromboxane synthesis inhibitory activities, *J. Med. Chem.*, 38 (1995) 3547-3557.
- [28] J. Liu, A. Maisonia-Besset, B. Wenzel, D. Canitrot, A. Baufond, J.M. Chezal, P. Brust, E. Moreau, Synthesis and in vitro evaluation of new fluorinated quinoline derivatives with high affinity for PDE5: Towards the development of new PET neuroimaging probes, *Eur. J. Med. Chem.*, 136 (2017) 548-560.
- [29] J. Liu, B. Wenzel, S. Dukic-Stefanovic, R. Teodoro, F.A. Ludwig, W. Deuther-Conrad, S. Schröder, J.M. Chezal, E. Moreau, P. Brust, A. Maisonia-Besset, Development of a New Radiofluorinated Quinoline Analog for PET Imaging of Phosphodiesterase 5 (PDE5) in Brain, *Pharmaceuticals* 9(2016).
- [30] F. Dolle, Fluorine-18-labelled fluoropyridines: advances in radiopharmaceutical design, *Curr. Pharm. Des.*, 11 (2005) 3221-3235.
- [31] SB Drug Discovery; [www.sbdrugdiscovery.com](http://www.sbdrugdiscovery.com).
- [32] L. Zhang, A. Villalobos, E.M. Beck, T. Bocan, T.A. Chappie, L. Chen, S. Grimwood, S.D. Heck, C.J. Helal, X. Hou, J.M. Humphrey, J. Lu, M.B. Skaddan, T.J. McCarthy, P.R. Verhoest, T.T. Wager, K. Zasadny, Design and selection parameters to accelerate the discovery of novel central nervous system positron emission tomography (PET) ligands and their application in the development of a novel phosphodiesterase 2A PET ligand, *J. Med. Chem.*, 56 (2013) 4568-4579.
- [33] H.H. Coenen, Fluorine-18 labeling methods: Features and possibilities of basic reactions, *Ernst Schering Res. Found. Workshop*, (2007) 15-50.
- [34] O. Jacobson, D.O. Kiesewetter, X. Chen, Fluorine-18 radiochemistry, labeling strategies and synthetic routes, *Bioconjug. Chem.*, 26 (2015) 1-18.
- [35] D.S. Noyce, J.A. Virgilio, Investigation of Rate of Hydrolysis of 1-Phenylethyl Phenylphosphinate as a Function of pH, *J. Org. Chem.*, 37 (1972) 1052-1053.
- [36] M.M. Claffey, C.J. Helal, P.R. Verhoest, Z. Kang, K.S. Fors, S. Jung, J. Zhong, M.W. Bundesmann, X. Hou, S. Lui, R.J. Kleiman, M. Vanase-Frawley, A.W. Schmidt, F. Menniti, C.J. Schmidt, W.E. Hoffman, M. Hajos, L. McDowell, R.E. O'Connor, M. Macdougall-Murphy, K.R. Fonseca, S.L. Becker, F.R. Nelson, S. Liras, Application of structure-based drug design and parallel chemistry to identify selective, brain penetrant, in vivo active phosphodiesterase 9A inhibitors, *J. Med. Chem.*, 55 (2012) 9055-9068.
- [37] Z. Li, P.S. Conti, Radiopharmaceutical chemistry for positron emission tomography, *Adv. Drug Deliv. Rev.*, 62 (2010) 1031-1051.
- [38] D.W. Kim, H.J. Jeong, S.T. Lim, M.H. Sohn, J.A. Katzenellenbogen, D.Y. Chi, Facile nucleophilic fluorination reactions using tert-alcohols as a reaction medium: significantly enhanced reactivity of alkali metal fluorides and improved selectivity, *J. Org. Chem.*, 73 (2008) 957-962.
- [39] D.W. Kim, D.S. Ahn, Y.H. Oh, S. Lee, H.S. Kil, S.J. Oh, S.J. Lee, J.S. Kim, J.S. Ryu, D.H. Moon, D.Y. Chi, A new class of S<sub>N</sub>2 reactions catalyzed by protic solvents: Facile fluorination for isotopic labeling of diagnostic molecules, *J. Am. Chem. Soc.*, 128 (2006) 16394-16397.
- [40] P. Marchand, A. Ouadi, M. Pelliccioli, J. Schuler, P. Laquerriere, F. Boisson, D. Brasse, Automated and efficient radiosynthesis of [<sup>18</sup>F]FLT using a low amount of precursor, *Nucl. Med. Biol.*, 43 (2016) 520-527.
- [41] H.S. Kil, H.Y. Cho, S.J. Lee, S.J. Oh, D.Y. Chi, Alternative synthesis for the preparation of 16 $\alpha$ -[<sup>18</sup>F]fluoroestradiol, *J. Labelled Comp. Radiopharm.*, 56 (2013) 619-626.
- [42] M. Suehiro, S. Vallabhajosula, S.J. Goldsmith, D.J. Ballon, Investigation of the role of the base in the synthesis of [<sup>18</sup>F]FLT, *Appl. Radiat. Isot.*, 65 (2007) 1350-1358.
- [43] J.H. Chun, S. Telu, S.Y. Lu, V.W. Pike, Radiofluorination of diaryliodonium tosylates under aqueous-organic and cryptand-free conditions, *Org. Biomol. Chem.*, 11 (2013) 5094-5099.

- [44] L. Brichard, F.I. Aigbirhio, An Efficient Method for Enhancing the Reactivity and Flexibility of [<sup>18</sup>F]Fluoride Towards Nucleophilic Substitution Using Tetraethylammonium Bicarbonate, *Eur. J. Org. Chem.*, (2014) 6145-6149.
- [45] J.H. Chun, S.Y. Lu, Y.S. Lee, V.W. Pike, Fast and High-Yield Microreactor Syntheses of ortho-Substituted [<sup>18</sup>F]Fluoroarenes from Reactions of [<sup>18</sup>F]Fluoride Ion with Diaryliodonium Salts, *J. Org. Chem.*, 75 (2010) 3332-3338.
- [46] D. Landini, A. Maia, A. Rampoldi, Dramatic Effect of the Specific Solvation on the Reactivity of Quaternary Ammonium Fluorides and Poly(Hydrogen Fluorides), (HF)<sub>n</sub>F<sup>-</sup>, in Media of Low Polarity, *J. Org. Chem.*, 54 (1989) 328-332.
- [47] A.F. Teich, M. Sakurai, M. Patel, C. Holman, F. Saeed, J. Fiorito, O. Arancio, PDE5 Exists in Human Neurons and is a Viable Therapeutic Target for Neurologic Disease, *J. Alzheimers Dis.*, 52 (2016) 295-302.
- [48] P. Cumming, A business of some heat: molecular imaging of phosphodiesterase 5, *J. Neurochem.*, 136 (2016) 220-221.
- [49] D. Giordano, M.E. De Stefano, G. Citro, A. Modica, M. Giorgi, Expression of cGMP-binding cGMP-specific phosphodiesterase (PDE5) in mouse tissues and cell lines using an antibody against the enzyme amino-terminal domain, *Biochim. Biophys. Acta*, 1539 (2001) 16-27.