

Zinc corrosion after loss-of-coolant accidents in pressurized water reactors - Thermo- and Fluid-dynamic effects

Seeliger, A.; Alt, S.; Kästner, W.; Renger, S.; Kryk, H.; Harm, U.;

Originally published:

June 2016

Nuclear Engineering and Design 305(2016), 489-502

DOI: <https://doi.org/10.1016/j.nucengdes.2016.06.006>

Perma-Link to Publication Repository of HZDR:

<https://www.hzdr.de/publications/Publ-23798>

Release of the secondary publication
on the basis of the German Copyright Law § 38 Section 4.

CC BY-NC-ND

Zinc corrosion after loss-of-coolant accidents in pressurized water reactors - Thermo- and fluid-dynamic effects

André Seeliger^a, Sören Alt^a, Wolfgang Kästner^a, Stefan Renger^a, Holger Kryk^b, Ulrich Harm^b

^a*Hochschule Zittau/Görlitz, Institute of Process Technology, Process Automation and Measuring Technology,
Theodor-Körner-Allee 16, D-02763 Zittau, Germany*

^b*Helmholtz-Zentrum Dresden-Rossendorf, Institute of Fluid Dynamics, P.O. Box 510119, D-01314 Dresden, Germany*

Abstract

Within the framework of the German reactor safety research, generic experimental investigations were carried out aiming at thermal-hydraulic consequences of physicochemical mechanisms, caused by dissolution of zinc in boric acid during corrosion processes at hot-dip galvanized surfaces of containment internals at lower coolant temperatures and the subsequent precipitation of solid zinc borates in PWR core regions of higher temperature. This constellation can occur during sump recirculation operation of ECCS after LOCA. Hot-dip galvanized compounds, which are installed inside a PWR containment, may act as zinc sources. Getting in contact with boric acid coolant, zinc at their surfaces is released into coolant in form of ions due to corrosion processes. As a long-term behavior resp. over a time period of several days, metal layers of zinc and zinc alloys can dissolve extensively.

First fundamental studies at laboratory scale were done at the Helmholtz-Zentrum Dresden-Rossendorf (HZDR). Their experimental results were picked up for the definition of boundary conditions for experiments at semi-technical scale at the Hochschule Zittau/Görlitz (HSZG). Electrical heating rods with zircaloy cladding tubes have been used as fuel rod simulators.

As near-plant core components, a 3×3 configuration of heating rods (HRC) and a shortened, partially heatable PWR fuel assembly dummy were applied into cooling circuits. The HRC module includes segments of spacers for a suitable representation of a heating channel geometry. Formations of different solid zinc compounds (mainly borates) were observed at the heatable zircaloy surfaces and characterized in detail during the heating-up to several coolant temperatures. As a strict consequence of their proven influence on heat removal and coolant flow behavior in the PWR core, preventive water-chemical methods were defined and tested.

Keywords: corrosion, decay heat, LOCA, reactor safety, zinc borate

1. Introduction

LOCAs are design-basis challenges for the safety of light water reactors such as PWRs. To remove the decay heat after a LOCA and to prevent the integrity of the fuel rods, the long-term behavior during LOCA in PWR is characterized by coolant discharge flow through the pipe leak in the primary cooling circuit, the collection of coolant in the containment sump and the recirculation to the reactor core by emergency cooling pumps as integral part of the ECCS. The decay heat removal can be influenced by the occurrence of several forms of debris materials in the sump (potentially inducing a clogging of the sump strainers upstream of the ECCS-pumps) or directly in the core. The debris materials in the sump can be heavily fragmented, like pipe insulations, occurring as particles of a fibrous substance with different settling properties. There were several attempts to differentiate between their forms of appearance and their attributes (Shaffer et al., 2003), (Seeliger et al., 2004).

A precedent case took place in 1992 in the BWR plant of Barsebaeck/Sweden. As a later consequence, also for PWRs, comparable cases have been considered experimentally and simulatively (Bröcker and Pointner, 2011). Due to different external materials with varying characteristics assembled worldwide, their

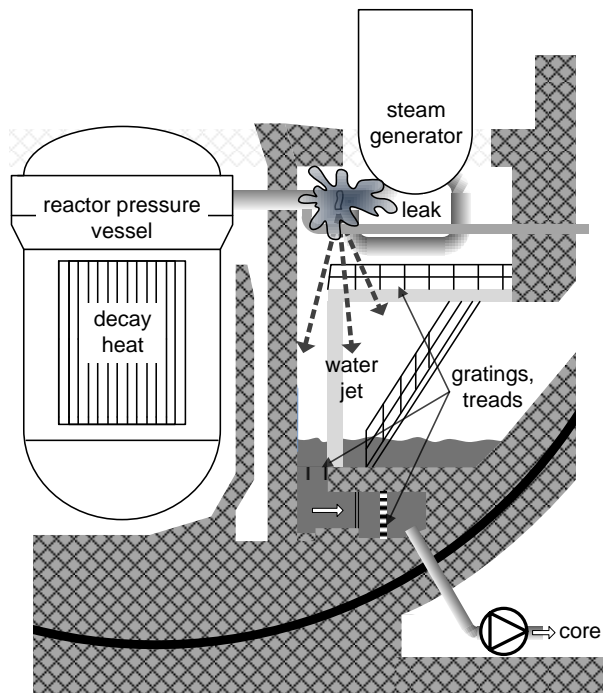

Figure 1: Scheme of LOCA scenario inside a German PWR

influence on coolant chemistry cannot be excluded for all cases. For the most part, components for realizing preventive measures were designed and installed, where their effects on thermohydraulics have been verified e.g. by complex numerical simulations (Krepper et al., 2011). A comprehensive overview of worldwide activities regarding the investigation of chemical effects (sump strainer clogging and downstream effects) is given in (Kryk et al., 2014), which provides the basis for the investigations described in the present paper. International investigations regarding LOCA along with the release of debris like pipeline insulation material as well as sump strainer clogging issues were performed in the past. Most long-term scenarios show one coincidence: Released materials have always been present in the core after passing the sump strainers, but their release was caused by exceptional processes like jet fragmentation. A further overview is given in the introducing part of (Krepper et al., 2011).

In the case described here, foreign materials are formed directly inside the core due to chemical effects leading under certain circumstances to so-called downstream effects (e.g. in-vessel effects). Constellations of boundary conditions and parameters may lead to the formation of zinc-containing corrosion products at plant components. The according PWR LOCA scenario inside the plant is shown schematically in Fig.1.

Within joint research projects between Hochschule Zittau/Görlitz (HSZG) and Helmholtz-Zentrum Dresden-Rossendorf (HZDR), generic investigations have been done regarding formation and deposition of solid corrosion products under LOCA conditions as a result of zinc corrosion processes in the presence of acidic borated water (coolant).

For first studies, potential zinc sources like containment installations of hot-dip galvanized steel (e.g. gratings, flight of stairs, inspection platforms, room divider and support grids of sump strainers) were considered. The layer structure of the hot-dip galvanized gratings (HGG), which mainly consists of pure zinc as external layer, a hard zinc layer and basic steel material, was determined by analyses of micrographs (Fig.2). Usually, the zinc is applied to the basic structure of the HGG by hot-dipping, which produces a continuous coat of 50-150 μm thickness (Kästner et al., 2012). This coat promotes a release of zinc, causing a change of the coolant chemistry as a long-term effect. Zinc will be released in form of ions by flow-induced corrosion effects.

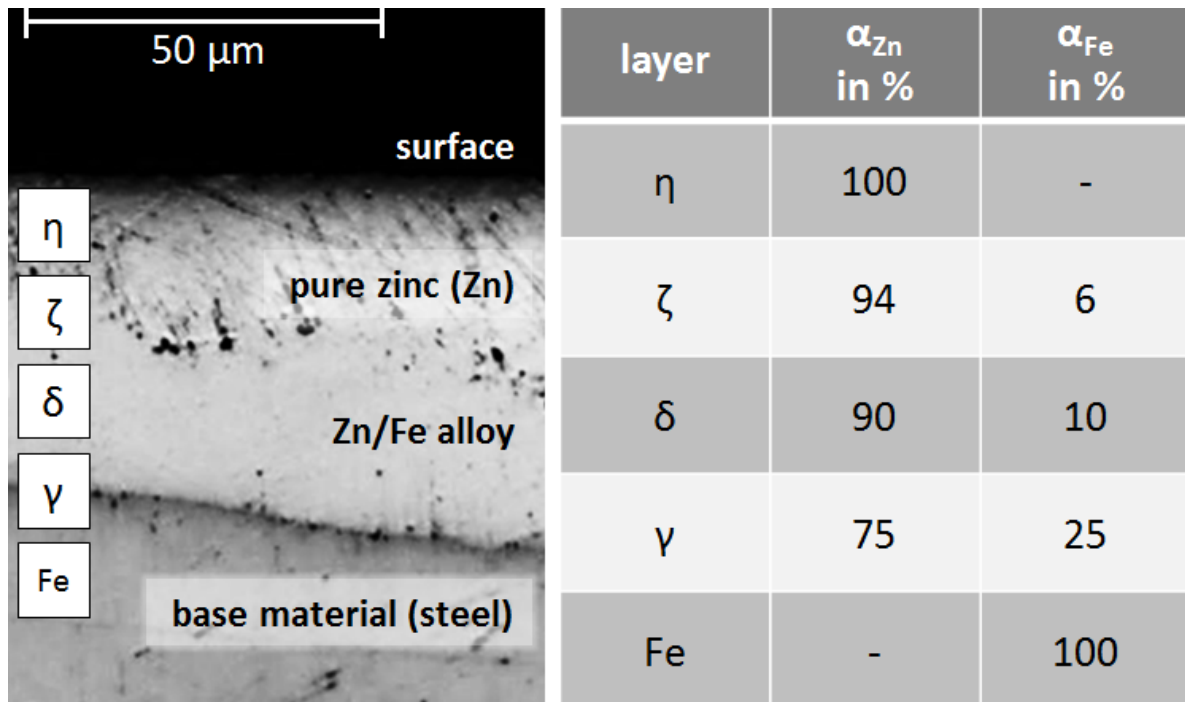

Figure 2: Zinc-containing layers of a hot-dip galvanized grating (HGG), according to sample analysis (Kästner et al., 2012)

In German PWR the coolant in the sump can contain up to 2300 ppm boron in form of boric acid as a mixture of primary circuit coolant, coolant out of the accumulators and from the ECCS flooding tanks. The pH-value of this assumed coolant in the sump may reach values from pH = 5.2 up to pH = 6.2 depending on the amount of lithium hydroxide, which is the common pH-buffering agent in German PWR. Especially, as no alkaline substances are added during a LOCA in several European PWRs, the pH may be less than 5.2. The borated coolant with dissolved zinc can reach core regions of higher temperature (hot spots), generating layer-forming compounds (Renger et al., 2013).

To complement according experiments done at laboratory scale (Kryk et al., 2014), selected boundary conditions were performed under near-plant geometries (e.g. fuel assembly, containment sump), processes (leakage jet) and installations (grids and strainers) at semi-technical scale. For this purpose, fuel rod simulators (FRS) with zircaloy cladding tubes, internally equipped with heating cartridges, have been applied. Its maximum heating surface load was estimated based on calculations according to DIN 25463-1 considering conditions inside a generic PWR 5 h after SCRAM.

No previous scientific work is known concerning modelling and simulation of these complex physico-chemical effects of precipitation, deposition and blockage of zinc compounds as well as their influence on thermo- and fluid-dynamic behavior of coolant and the heat transfer inside the PWR core.

2. Fundamentals

First fundamental lab scale experiments are described in (Kryk and Hoffmann, 2014) and (Kryk et al., 2014). The latter gives an overview of experimentally detected zinc solubility behavior at different temperature regimes of coolant in the core. Results indicate a cycle showing growing corrosion effects (viz. release of zinc ions) at lower coolant temperatures. In contrast, there are increased precipitations of solid corrosion products at higher coolant temperatures, if oversaturation occurs. The resulting solid corrosion products were identified by chemical analysis as zinc borates (general formula: $xZn \cdot yB_2O_3 \cdot zH_2O$) where different types of zinc borates may occur depending on their forming temperature. Thus, zinc solubility scheme

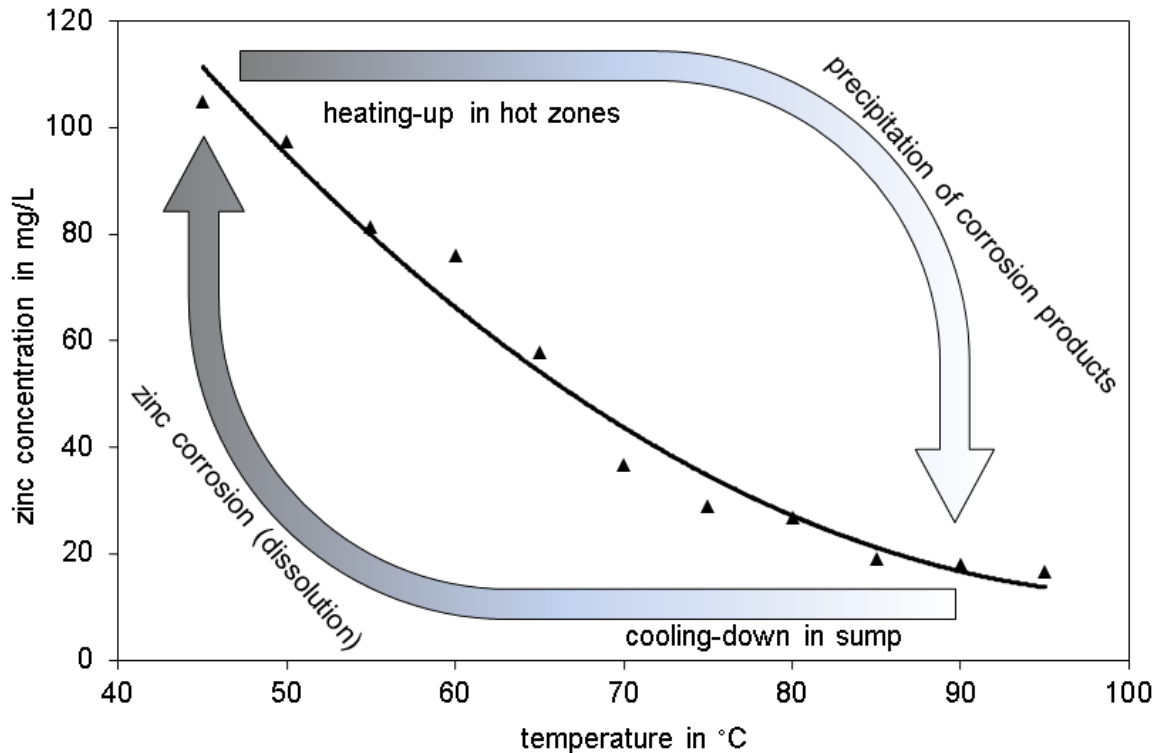

Figure 3: Zinc solubility scheme according to lab scale tests of the HZDR (Kryk et al., 2014)

with the emphasis on dissolution and precipitation processes shown in Fig.3 gave an orientation to the experimental parameterization at semi-technical scale, performed at test rigs as described in the following.

Zinc, which is released into coolant in form of ions, hereby stands as primary corrosion product (CP). Any further solid compounds (e.g. precipitations of zinc borates, ZBP), which are formed as a consequence of this release, are considered as secondary CP. With regards to LOCA scenario, the concentration of primary CP increases due to the lower temperature and the corrosion in the containment sump and decreases after passing hot channels in the reactor core. Hence, decreasing solubility can lead to ZBP in these channels.

3. Experimental setup

The investigations include mainly effects on thermal-hydraulic processes at semi-technical scale. At HSZG, a double-tracked experimental strategy was pursued using two test facilities for experiments:

- Ring Line II (RL2); a modular, highly observable test facility for investigating multiphase flow phenomena in a cooling circuit. It provides best conditions for visual observation of occurring processes at the expense of a near-plant geometry.
- Zittau Flow Tray (ZFT); a scaled PWR sump model, connectable e.g. to a partially heatable, shortened fuel assembly (FA) dummy. ZFT provides near-plant conditions and geometries but with less observation possibilities and therefore a limited application of visual measurements.

3.1. Ring Line II (RL2)

Test facility Ring Line II (RL2) was designed for camera-based investigations of multiphase flow phenomena (gas-solid-liquid flows) in complex near-plant geometries in order to investigate separate effects regarding the sump performance after LOCA. Additionally, it allows for analysis of head loss caused by

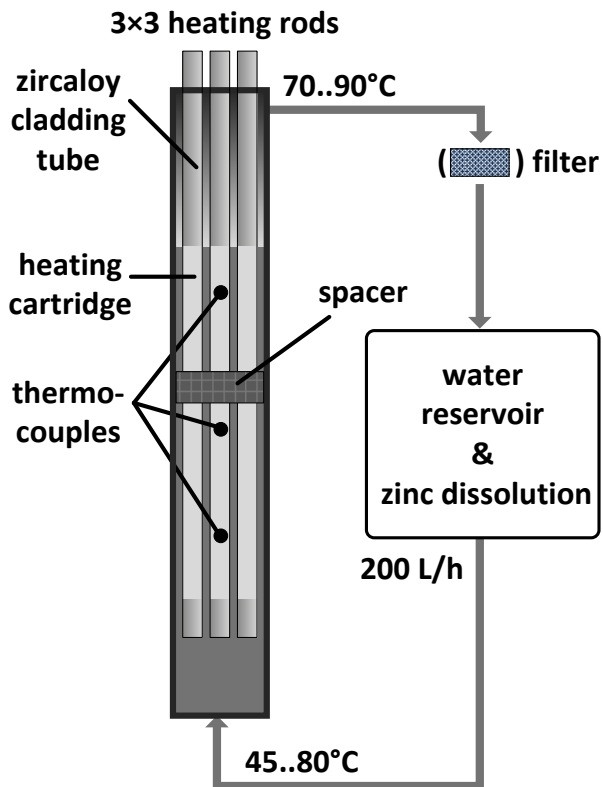

Figure 4: Simplified scheme of test rig Ring Line II (RL2) including 3×3 heating rod configuration (HRC)

released particles accumulating on horizontal and vertical retaining devices (e.g. spacers and strainers). These devices are supplemented by a 3×3 heating rod configuration (HRC) representing the sub-geometry of PWR heating channels. Fig. 4 shows a simplified scheme of test facility RL2 and a special channel segment containing the 3×3 HRC. Each heating rod acting as a fuel rod simulator (FRS) has a controllable power of 1160 kW maximum. FRS cladding tubes are made of zircaloy as the common PWR fuel rod cladding material. Equipped with heating cartridges, their heating power is constant over a heatable length of 580 mm.

The HRC can be equipped with 3×3 spacer segments. It is placed in a stainless steel housing (50×50 mm in cross section) with observation windows made of temperature- and pressure-resistant borosilicate glass, allowing for permanent observation of rod surfaces and visual measurements. Inlet and outlet of the HRC are windowed for detecting any released ZBP transported by the coolant flow. The filling volume of the hereby simulated cooling loop including its water reservoir, piping and various channel segments (see Fig. 5) is up to 320 L.

Optionally, zinc granules with a purity of 99.9 % can be placed inside the water vessel (marked as B4 in the upper part of Fig. 5) as a zinc source. But for most experiments, zinc-containing coolant was prepared in advance in a separate, simple cooling loop. Here, zinc ions were released by the corrosive impact of an open jet onto a porous bed of granules.

All experiments at the RL2 were done with variation of parameters like

- coolant concentrations of boric acid (about 2300 ppm boron, resp. 13 g/L boric acid) and lithium (usually 0.5 ppm lithium as lithium hydroxide),
- heat output of the heating rods,

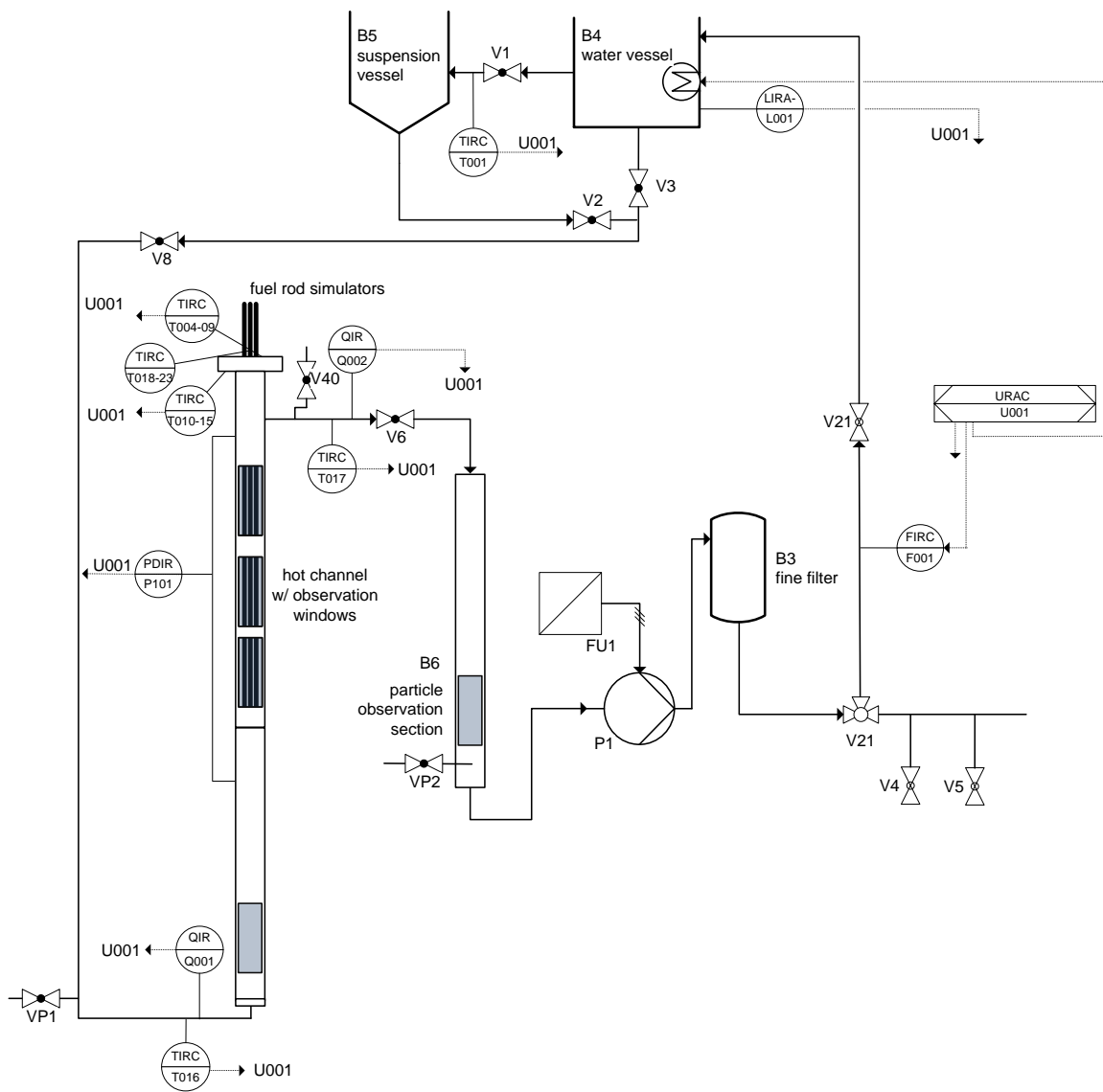

Figure 5: Piping and instrumentation diagram of the test facility Ring Line II (RL2)



Figure 6: Test facility Zittau Flow Tray, a PWR scaled sump model with maximum capacity of 18 m^3

- initial zinc concentration in the coolant,
- presence of a zinc source (pure zinc granules) and
- number and position of spacer segments.

The predefined concentration of boric acid results from the injection of two flooding tanks of ECCS into primary cooling circuit as a regulatory process during the LOCA scenario.

3.2. The Zittau Flow Tray (ZFT)

The Zittau Flow Tray (ZFT, see Fig.6) as the storage component of a simulated coolant circuit on semi-technical scale is a scaled PWR sump model, mainly used for investigations of particle-laden coolant flows regarding complex effects of sump performance in the past. It offers a maximum fluid volume of 18 m^3 . The tray itself with the dimensions of $3.0 \times 1.0 \times 6.0\text{ m}$ ($H \times W \times L$) and its piping system (Fig.7) consists of stainless steel to make it resistant to chemicals, corrosion and coolant temperatures up to $80\text{ }^\circ\text{C}$.

Compared to the geometric boundary conditions of a PWR LOCA scenario, the tray length of 6.0 m corresponds to the estimated distance between leakage jet impact and the sump strainer. The maximum filling height of 2.6 m represents a realistic filling level in the containment sump of PWR during the sump circulation operation. Special nozzles allow for simulations of jet forms with different spraying patterns caused by different kinds of pipe leakages. For simulating a leakage jet, a full cone nozzle was installed to get a circular spray cone with an exit angle of 90° . New as well as older HGG, which were used in NPP before, act as zinc sources in the ZFT facility. The HGG can be installed at several positions inside ZFT in order to consider the given diversity of corrosion effects due to local thermal-hydraulic conditions (Fig.8). In accordance to real plants, gratings located horizontally under the simulated leakage jet represent e.g. inspection platforms above the coolant level, vertically oriented HGG located below the coolant level nearby the sump strainer represent its support grids.

ZFT allows for additional installations of downstream components (fine debris filters, FA dummy etc.) behind variable strainer configurations located in front of the suction box (resp. sump suction area). Acrylic glass windows in the tray wall allow observation of the strainer and inserted installations. Furthermore, ZFT is equipped with sampling points in order to take samples of coolant during operation for further chemical analyses.

An internal cooling loop at the tray bottom as well as three flanged heaters (38 kW of electrical heating power each, see obj. H1-H3 in Fig.7) inside the suction box are used for automatic regulation of the coolant temperature. For investigating downstream effects in detail, single or clustered FA dummies partially

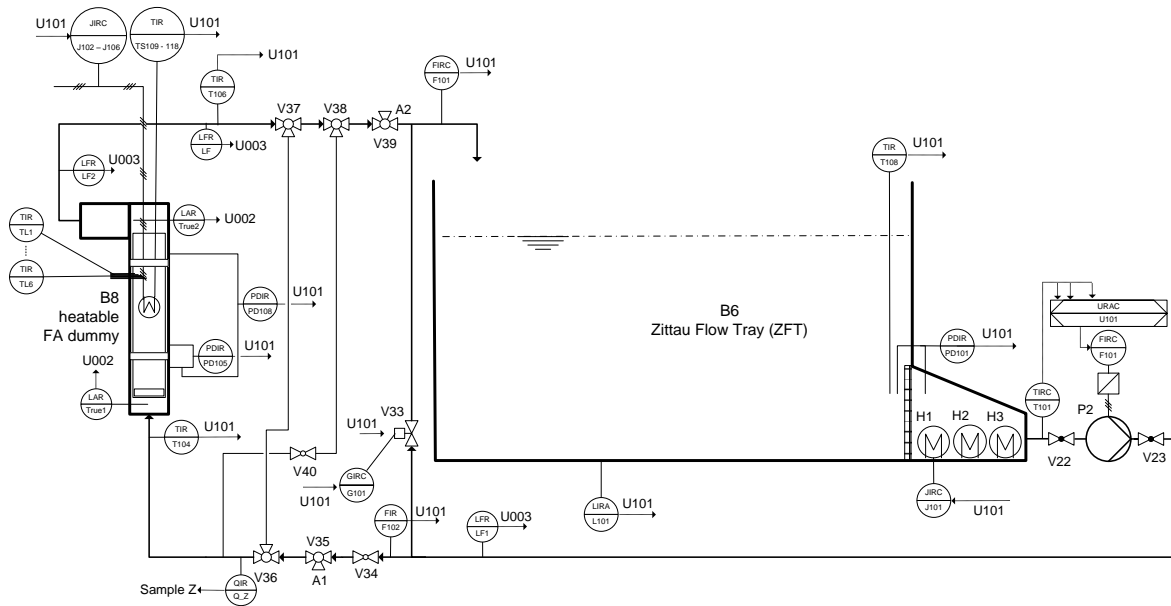

Figure 7: Piping and instrumentation diagram of the test facility Zittau Flow Tray (ZFT)

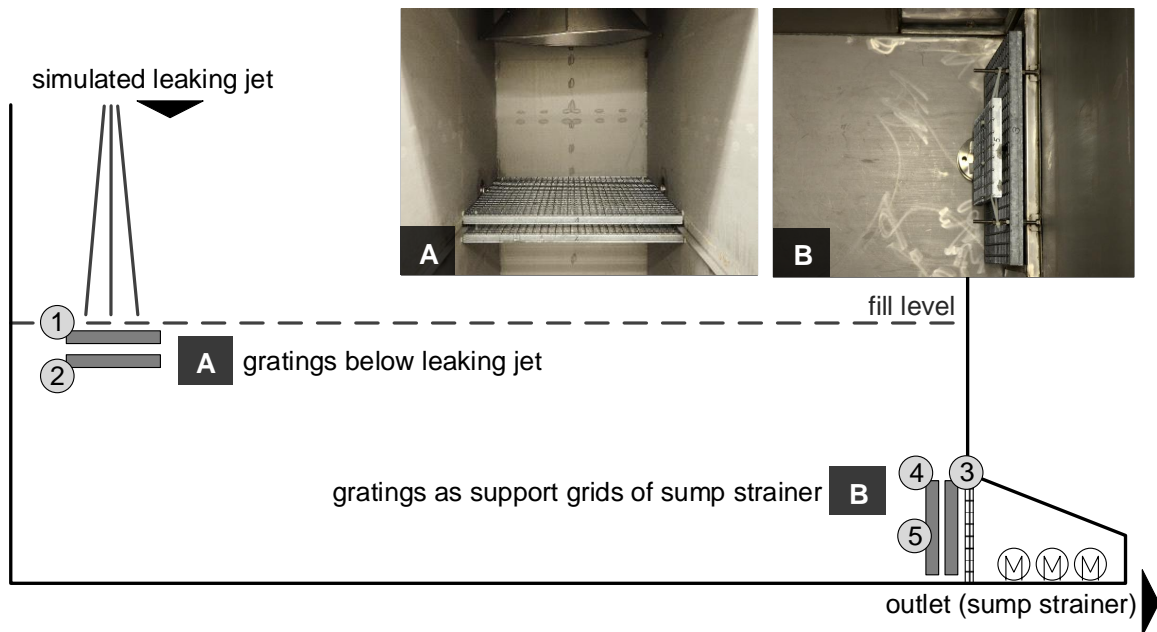

Figure 8: Hot-dip galvanized gratings (HGG) as zinc sources, located at two main positions (A/B) inside the test facility ZFT (exp. no. ZFT-BE-V03)

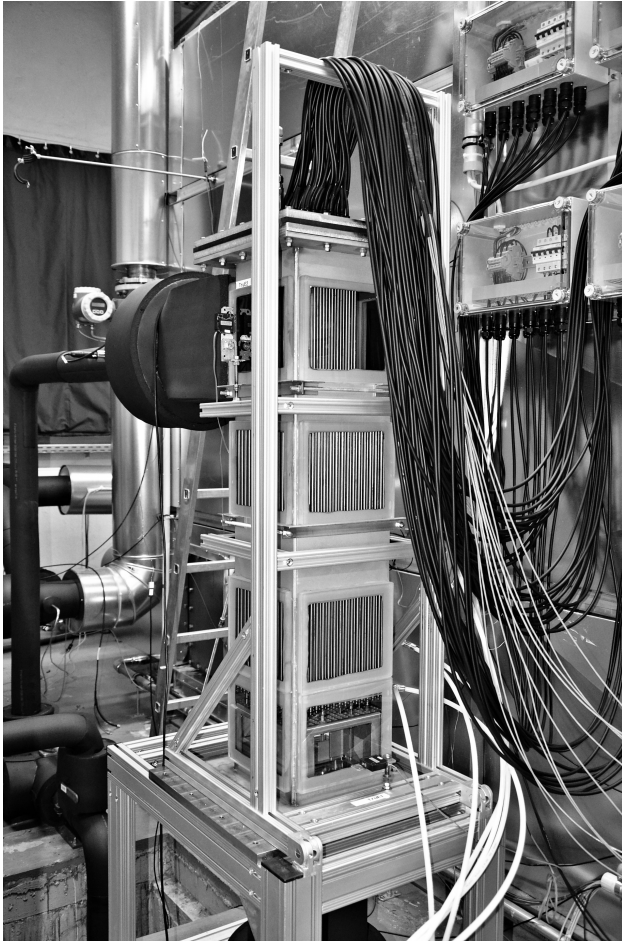

Figure 9: Partially heatable PWR FA dummy including wirings of the fuel rod simulators (FRS)

equipped with FRS can be connected to the piping system, considering also particular flow conditions like bypasses.

Fig.9 shows a single shortened 16×16 PWR FA dummy with two spacers and bottom with a 3.5×3.5 mm integrated debris filter (IDF), installed downstream the sump suction area of the ZFT. It consists of 8×8 heatable FRS, 20 control rod simulators and two 16×16 spacers. It is encased in a windowed stainless steel housing for better observability.

The following parameters have been varied according to possible LOCA scenarios:

- coolant volume inside the flow circuit (8.17 m^3) and, as a consequence of early evaluations, its concentration of lithium (usually 0.5 ppm as lithium hydroxide)
- number, size (resp. area of corrosion surfaces) and position (below leakage jet, immersed or not immersed, near strainer etc.) of HGG
- heat output of heating rods acting as FRS

Initial concentration of boric acid has been kept constant at about 2300 ppm boron. The shape of the leakage jet and the flow rate of the coolant ($25.11 \text{ m}^3/h$) were not varied. Flow direction inside FA dummy was considered to be from bottom to top with $5.13 \text{ m}^3/h$ (i.e. flow velocity between rods: 5 cm/s). All experiments done at the ZFT are divided into

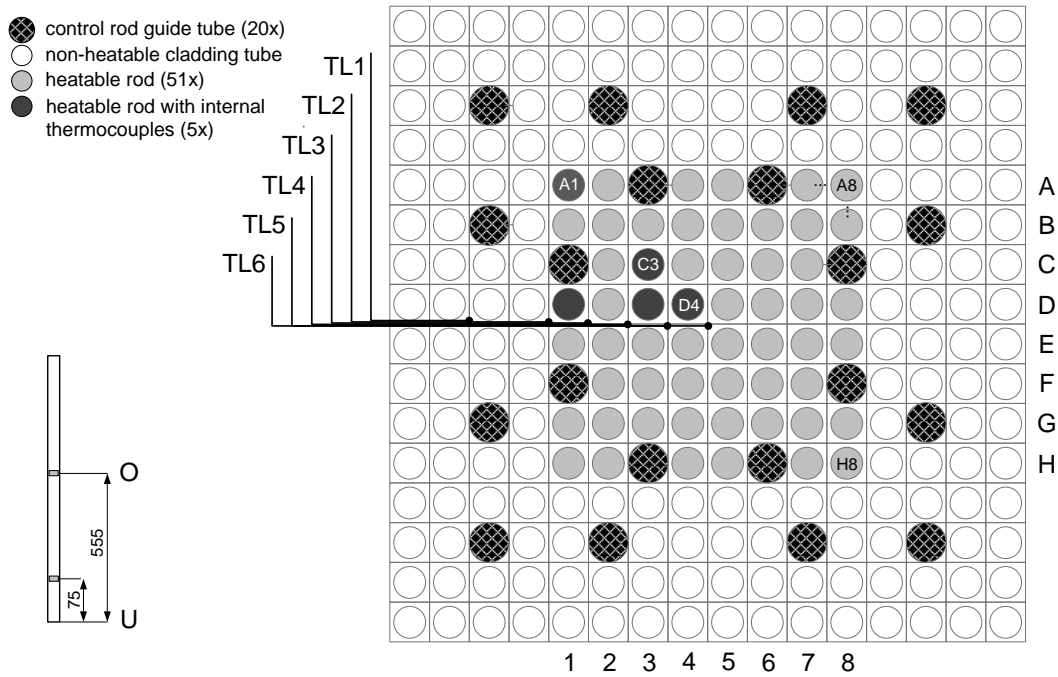

Figure 10: Positions of thermocouples inside the heating rod at two height positions (small scheme on the left), inside the 16×16 configuration of the partially heatable fuel assembly (depicted in cross-sectional view on the right) and the according sensor naming scheme

- zinc release (ZR) exp.: Only the zinc sources (HGG) and thereby the time-dependent release of zinc into coolant are considered experimentally.
- full effect (FE) exp.: Zinc sources as well as zinc sinks (heatable core components) are integrated into the circuit.

3.3. Measuring equipment and experimental schedule

Filling level of ZFT is permanently controlled by differential pressure transmitter, considering the density of the medium. Thermocouples (TC) partially combined to measuring probes are used to measure local coolant temperatures between the rods. Additionally, TC are installed inside the FRS (between the heating cartridges and the cladding tubes) at upper and lower positions (Fig.10) in order to estimate the influence of layer-forming deposits on the heat transfer processes.

Further instrumentation consists of

- electromagnetic inductive flow meters for measurement and control of volume flow over ZFT outlet, FRS, bypass, and ZFT inlet (resp. the simulated leakage jet),
- conductivity probes at inflow and outflow of the FRS for determining zinc concentration in the coolant and
- head loss gauges for measurement of differential pressure over simulated core components induced by ZBP.

Table 1: Parameters for selected experiments at test facility RL2

exp. no.	mean linear power in W/cm	init. zinc conc. in mg/L	final zinc conc. in mg/L
6	5.36	78.3	23.3
8	6.67	86.2	17.3
11	5.38	93.1	19.2
14	2.71	90.7	37.2
20	1.22	129.4	66.4

The FA geometry did not allow for application of more complex images-based measuring methods. For RL2, process instrumentation was nearly similar. For real-time observation of the formation, deposition and spalling of secondary CP on heatable surfaces, a digital microscope was installed at an observation window of the HRC module. At inlet and outlet, the turbidity of the coolant is measured by thru-beam laser sensors (TLS), using visible monochromatic light of 660 nm wavelength emitted by a semiconductor of laser class 2. Its measuring sequences indicate presence, approximated quantity, the recirculation behavior and release times of solid CP. Every experiment was documented by video recordings at the observation windows. Quantifications of the formed solids and their size distributions were determined by digital image processing, digital microscopy and laser diffraction particle size analysis.

For most experiments at the RL2, zinc-containing coolant was prepared in a separate test facility. In addition, experiments were carried out at RL2 using zinc-containing coolant, which was prepared by ZR experiments in the test facility ZFT. The initial Zn concentration varied from 78 up to 130 mg/L. The initial pH-value varied between 6.61 and 6.78 due to the varying zinc concentration in the boric acid coolant. Every experiment was finished after reaching a quasi-stationary (e.g. when a significant increase on ZBP is not to be expected anymore) or a barely controllable state (e.g. when hindered heat transfer led to continuous boiling processes at the FRS).

The experimental schedule for both test rigs reads as follows:

- filling up coolant with a defined initial concentration of zinc, boric acid and lithium in terms of LiOH
- heating up coolant to initial fluid temperature of 45..50 °C by an additional heating system
- starting of full coolant circulation with predefined heating power of FRS
- during experiment: camera observations; sampling; online measurements of temperatures, head losses and conductivity; operator inventions (e.g. power regulation), if necessary
- at the end of experiment: stop circulation; dispose coolant; inspect components for gathering ZBP; follow-up processing

As a follow-up task, total mass of corroded zinc removed from the HGG surface was simplistically determined by backweighing all HGG. On the whole, all tests done were generic, considering only a simplified scale-down of coolant volume and available zinc resources.

4. Experimental Results

4.1. Results of RL2 experiments

20 experiments (namely RL2-HZ9-Vxx, see Table 1 for the details of some selected experiments) were done at RL2, varying mainly the initial Zn concentration (range 78..129 mg/L), therefore pH-value and heating power (1.2..6.8 W/cm), aiming at the precipitation behavior of zinc at hot spots. Initial concentrations of lithium (0.5 ppm) and boric acid (13 g/L) were retained.

Confirmed by turbidity measurements taken by TLS at the outlet of the HRC, first colloidal CP precipitations turned the coolant into a turbid solution soon after putting the FRS into operation. Its colloidal size

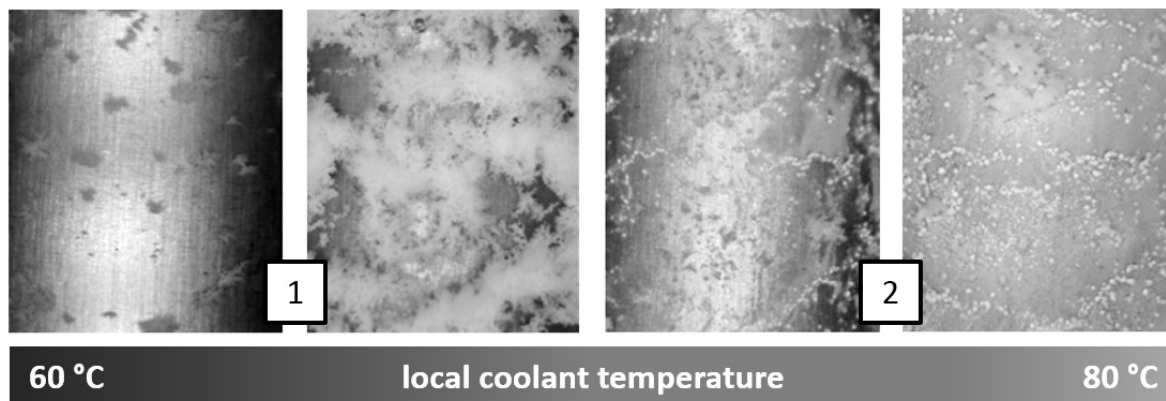

Figure 11: Two forms of appearance of secondary corrosion products (CP) on the surface of heating rods occurring in the local coolant temperature range of 60..80 °C (exp. no. RL2-HZ9-V08; initial concentrations: 13.0 g/L of boric acid, 86.2 mg/L of zinc)

did not allow any further analysis of the disperse phase. Further secondary CP appeared at higher coolant temperature ranges and can be classified on the basis of the following characteristics:

1. Temperature range 60..70 °C: flocculent, easily mobilisable CP; forms crystalline sparse layers at surfaces; massively released particles are flocs with irregular shape, forming altogether a polydisperse phase.
2. Temperature range 70..80 °C: hardly/not mobilisable CP; forms solid, dense layers at surfaces; only few particles were released into the coolant as spallings with various shapes/sizes up to 12 mm major length.

An enhanced affinity of adhesion was detected with increasing coolant temperature. Images were taken online at the metal surface of a heating rod to document this phenomenon. Assuming a zinc concentration of 86.2 mg/L (exp. no. RL2-HZ9-V08) as an example, Fig.11 shows the according flocculent substances and increasing solidified layer-forming deposits at the FRS surface (from left to right with increasing coolant temperature).

The investigation of the impact of the initial Zn concentration on the formation and behavior of ZBP was one aim of the analyses: Benchmark experiments with nearly identical boundary conditions showed that higher concentrations lead to comparatively more dense and more inhomogeneous deposit layers (see Fig.12), also affecting mass balances in general (RL2-HZ9-V06: 14.58 g / RL2-HZ9-V11: 23.14 g total mass of ZBP).

Head losses at spacer segment persisted for several hours (60 h/25 h for exp. no RL2-HZ9-V06/V14). They were caused by deposits of both, the solidified as well as the flocculent CP. The latter formed a dense pasty substance at the spacer, which dried out to a solid mass after its removal at the end of experiment (see Fig.13).

Any decrease of head loss at the spacer segment as shown in Fig.14 was mainly caused by occurring degassing effects (due to degassing of the upper housing by the operator) and partial relocation of ZBP in the longer term.

Due to increasing adhesion affinity of zinc borate with increasing forming temperature, its removal from surfaces by the coolant flow itself gets difficult. Most CP, detached from surfaces of heating rods, form loose sediments at piping components like pipe elbows, the water reservoirs and further low-flow areas of the RL2. According to the zinc solubility curve shown in Fig.3, higher zinc concentrations lower the minimum coolant temperature required for CP precipitations. In case of an initial Zn concentration of 129.4 mg/L in exp. no. RL2-HZ9-V20, first flocculent CP already occurred during the preparation process of heating-up to 45 °C of coolant temperature. After this, linear heat output of each rod was kept constant at 6.85 W per cm. Due to their low adhesion affinity and high mobilization ability, all occurring flocculent CP were easily transported

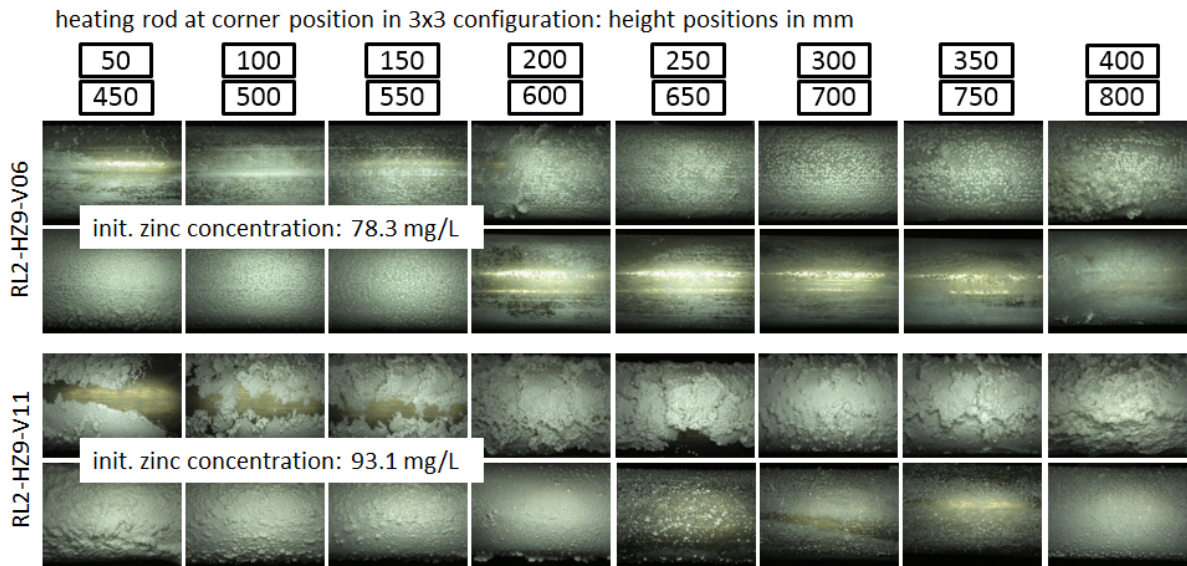

Figure 12: Appearance of layer-forming CP along the surface of a heating rod with flow direction from bottom to top at corner position in dependence of initial Zn concentration (in dry state, after exp. no. RL2-HZ9-V06 and V11)

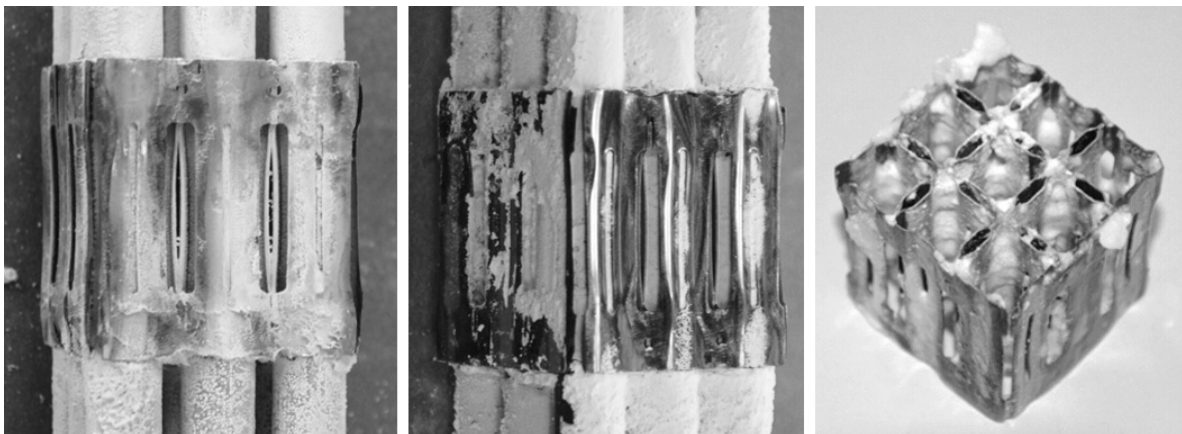

Figure 13: 3 × 3 spacer segments with CP deposits in dry state after exp. no. RL2-HZ9-V06, V11 and V14 (from left to right)

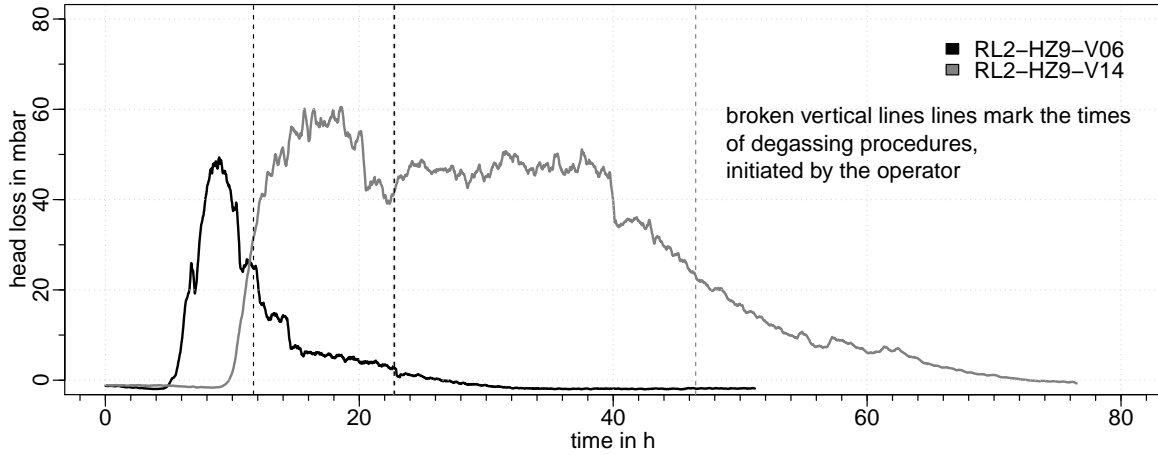

Figure 14: Course of head loss at the spacer segment of the HRC caused by various CP deposits (exp. no. RL2-HZ9-V06 and V14)

Table 2: Parameters for all experiments done at test facility ZFT

exp. no.	type of experiment	Li conc. in ppm	mean linear power in W/cm
1	FE	0.5	2.79
2	FE	0.5	5.54
3	FE	0.5	4.74
4	ZR	38	-
5	FE	38	4.55
6	FE	15	4.3
7	ZR	0.5	-
8	FE	0.5	5.02

with the flow, forming larger sediments in downstream components. Remaining inhomogeneous layers of CP still influenced heat removal at the FRS. Consequently, internal rod temperatures increased from about 100 up to 160 °C. Altogether, experiments at RL2 gave a first proof of possible blockages in heat channels, at spacers and downstream components, considering technical scale. They show that zinc borates occur in similar temperature-depended phases according to lab results in (Kryk et al., 2014).

4.2. Results of ZFT experiments

Altogether, eight experiments (namely ZFT-BE-Vxx, see Table 2 for selected parameters) were carried out at the ZFT facility, five of them done without any change of coolant chemistry. Exp. no. 1 and 2 as well as 4 and 5 were performed consecutively, meaning that the final parameters of the predecessor experiment were the initial parameters of the following one.

Time-dependent zinc dissolution resp. corrosion was investigated for HGG placed at different positions in the ZFT. Results prove that borated coolant supports corrosion processes at hot-dip galvanized surfaces. Fig.15 shows close-ups of HGG before and after LOCA simulation, confirming different stages of zinc loss and corrosion patterns.

Fig.16 shows the zinc release rates of HGG determined by mass balances and conductivity measurements in exp. no. ZFT-BE-V03 as an example, indicating accelerated layer degradation by flow-induced corrosion including entrained air. For HGG located below the simulated leaking jet slightly below the surface of the

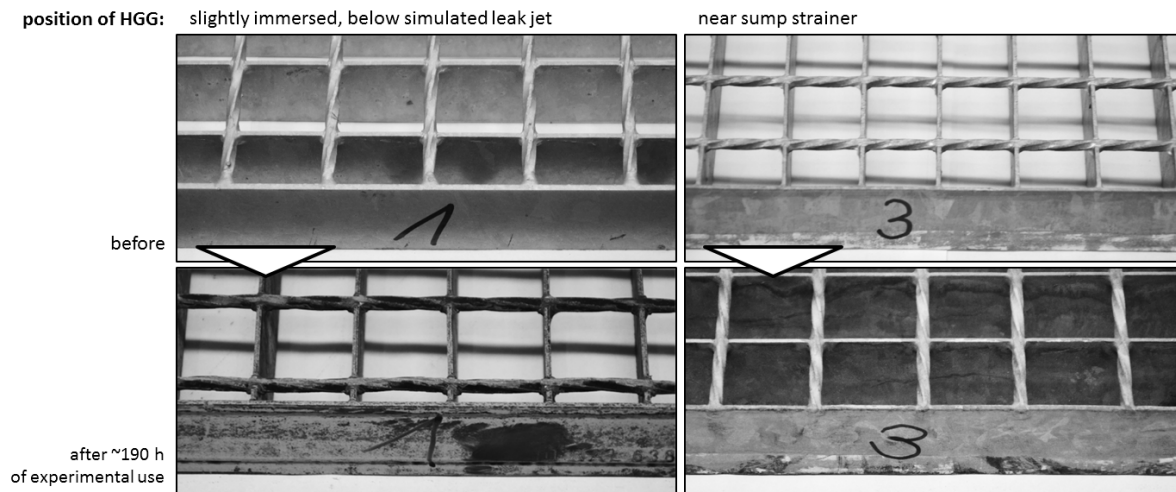

Figure 15: Close-ups of HGG located immersed below simulated leakage jet (left) and fully immersed near sump strainer (right) in ZFT before and after experimental use (exp. no. ZFT-BE-V03)

water bed, the presence or entrainment of air came along with an increase of corrosion rate. HGG near the sieve at the simulated sump outlet mainly showed lower Zn release rates. The removal of the layers took place very homogeneously.

Altogether, the yield of HGG as a zinc source correlates clearly with its size resp. the area of its contact surface. Corrosion impact of immersed HGG depends also on local flow pattern (see Fig.15). After uncovering the pure zinc layer, iron oxide was released. Chemical analyses confirmed a Zn solubility behavior as determined in (Kryk et al., 2014) before: At low Zn concentrations of the coolant, corrosion effects are more prevalent. Reaching the temperature-dependent solubility limit, precipitation processes are strengthened.

Due to the flow direction of the coolant along the heated rods from bottom to top, temperature of solution rises along the heating rod, causing an increase of thickness of the CP layer upwards in flow direction. Over time, incrustations formed layers of high porosity. Their influence on thermohydraulics is significant: After 40 h of operation in exp. no. ZFT-BE-V03, temperatures of rods and surrounding coolant started to rise slightly. Coolant temperatures in the center of the FA dummy reached the boiling limit of 100 °C after 140 h, accompanied by noticeable boiling noises. Increasing internal rod temperatures with a temporary maximum of nearly 210 °C are evidence of hindered heat transfer too (see Fig.17). These effects were reproducible. Due to the existence of alternative free flow paths through non-heatable, open channel areas, there was no head loss build-up measureable along the FA dummy. After each experiment, CP deposits were found even at non-heatable surfaces, e.g. solidified spallings, originating from the deposit layers round the heating rod surfaces.

Sediments of fines mainly occur at locations in the coolant circuit where the flow direction changes, e.g. in pipe elbows. By the inspection of the FA dummy in backlight, cloggings between the rods became visible. Incrusted deposits formed one massive clogging in the center of the FA dummy, which came along with a significant change of the flow distribution inside the core (increasing surrounding flows), causing hindered heat removal. Fig.18 shows the blockage inside the core after dismantling some of the covering non-heatable fuel rod dummies.

HGG showed oxide layers with brownish to black discolorations, which indicate a removal of the pure zinc and the uncovering of steel by corrosion effects. According to chemical analyses using Raman spectroscopy and ICP-MS done at the HZDR, chemical compositions of occurring compounds and the resulting physical/chemical characteristics (density, water solubility, adhesion tendency etc.) depend mainly on their forming temperature.

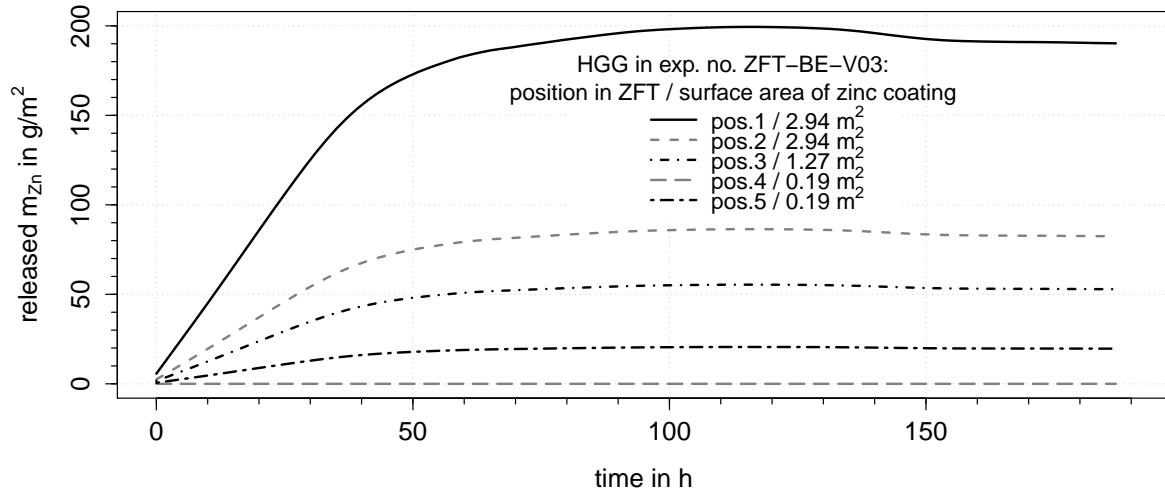

Figure 16: Released masses of zinc over experimental time acc. to mass balances of HGG installed at several positions inside ZFT (exp. no. ZFT-BE-V03, for HGG positions see Fig.8)

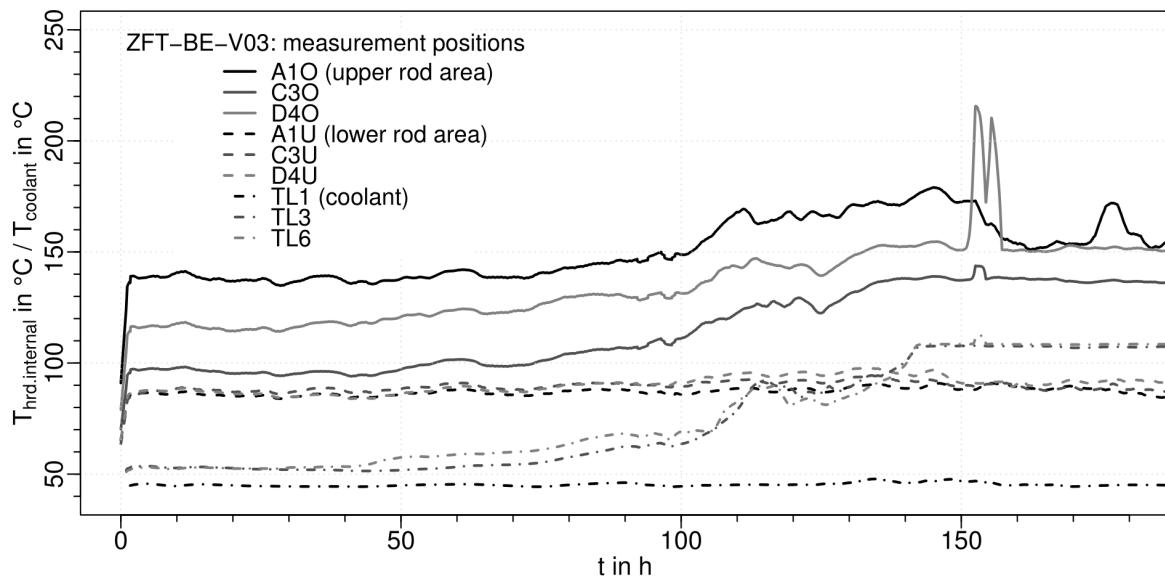

Figure 17: Internal rod temperatures and coolant temperatures (exp. no. ZFT-BE-V03, for TC positions see Fig.8)



Figure 18: CP caused blockings inside the FA dummy (in dried state, after exp. no. ZFT-BE-V01; flow direction from left to right)

5. Preventive measures

Since precipitation of solid corrosion products inside the core cannot be excluded, water-chemical measures were tested in order to prevent both, corrosion and deposition processes after LOCAs in PWRs. As mentioned above, corrosion processes are strongly reduced as the zinc concentration in the coolant rises. The increased zinc concentration leads to an increase of the pH-value of the coolant as the results of pH measurements during corrosion experiments in the ZFT show (see Fig.19).

Therefore, alkaline treatment of the coolant as an acceptable preventive measure was tested. The treatment was done with overdoses of lithium (13.0 and 38.0 ppm) as lithium hydroxide. Due to the chosen lithium hydroxide concentrations, the initial pH of the coolant stays in the neutral region ($\text{pH} = 6.7..7.2$) in order to prevent both, the formation of sparingly soluble by-products as zincates as well as increased foaming of the coolant at higher pH-values. Fig.20 shows the courses of the zinc concentrations in the coolant determined during the according experiments. Despite of identical test parameters (size and position of zinc sources, flow rate etc.), a reduction of Zn release and thus an impact on corrosion rate is clearly recognizable at experiments with enhanced lithium concentration.

Fig.20 shows the course of coolant pH over time for all experiments considering coolant with an initial zinc concentration of 0.0 mg/L. By comparing results for all three alkalization levels at enhanced initial pH-values of the coolant, there are recognizable differences in the courses, due to the decreased release of ionic zinc as before.

During experiments considering alkalization, there was an improved but still hindered heat removal, indicated by internal rod temperatures up to 110 °C for 15 ppm Li resp. 76 °C for 38 ppm Li. Deposits were still found along FRS and near the upper spacer in flow direction (Fig.22). Small gaps between FSR and the spacer near and inside the heatable zone were partially or fully clogged.

Differences in coloration and consistency (from solid/highly adhesive to brittle/porous) indicate that various secondary CP were formed as mixtures depending on pH-value of the coolant. Fig.23 shows the masses of all ZBP, which were gathered at the end of experiments. It should be mentioned that several Zn borates with different mass densities exist. For possible compositions of CP see also (Kryk et al., 2014).

Based on the experimental results, it can be summarized that a significant reduction of zinc borate precipitation is possible by moderate alkalization of the coolant using additional lithium hydroxide. However, a complete prevention of corrosion and/or precipitation is not realizable within the neutral pH region.

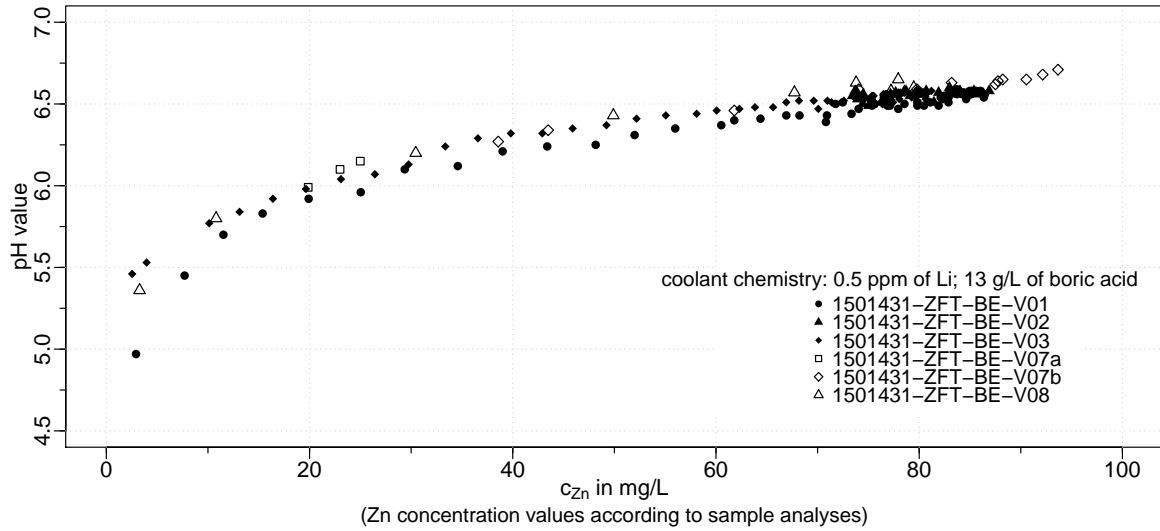

Figure 19: Relation between Zn concentration of coolant and its pH for standard coolant chemistry

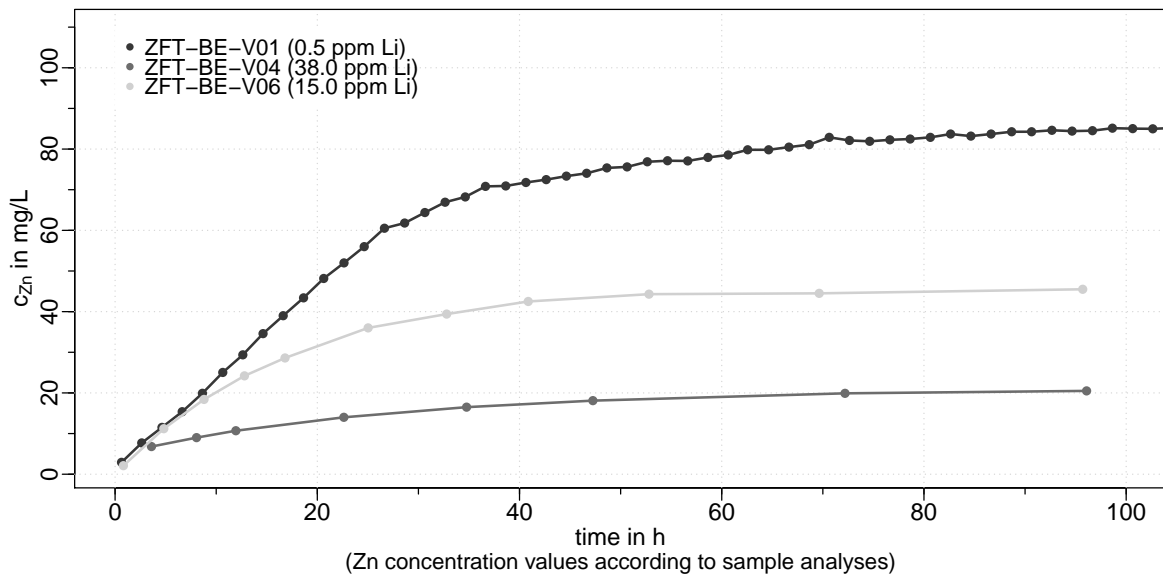

Figure 20: Courses of Zn concentration in the coolant in dependence of corrosion effects for several alkalization levels for the first 100 h experimental time (exp. no. ZFT-BE-V01, V04 and V06)

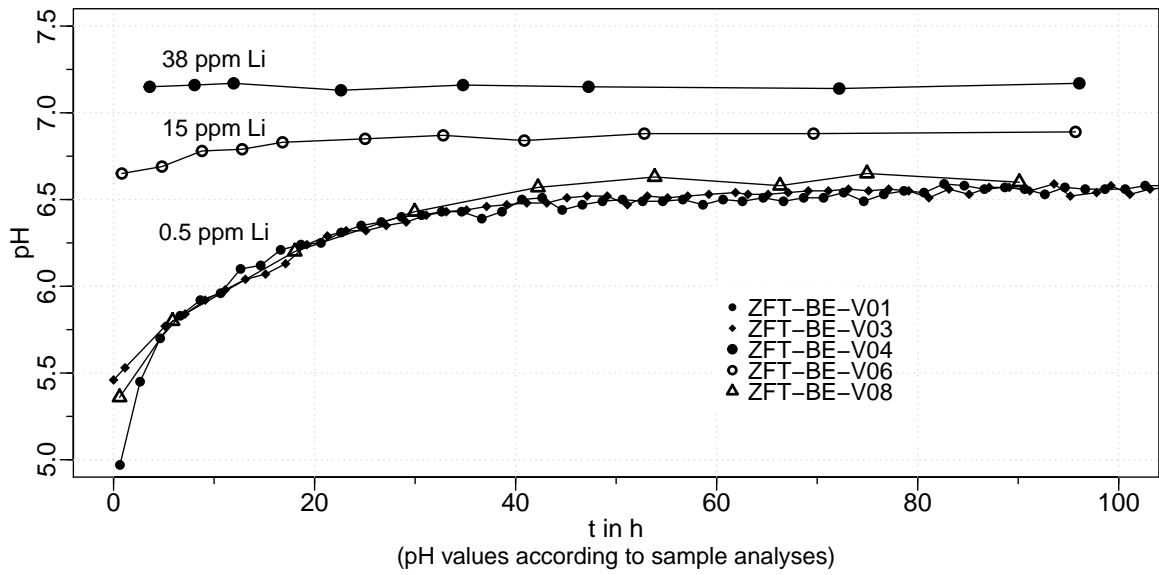

Figure 21: pH over time for experiments at test rig ZFT with an initial zinc concentration of 0.0 mg/L

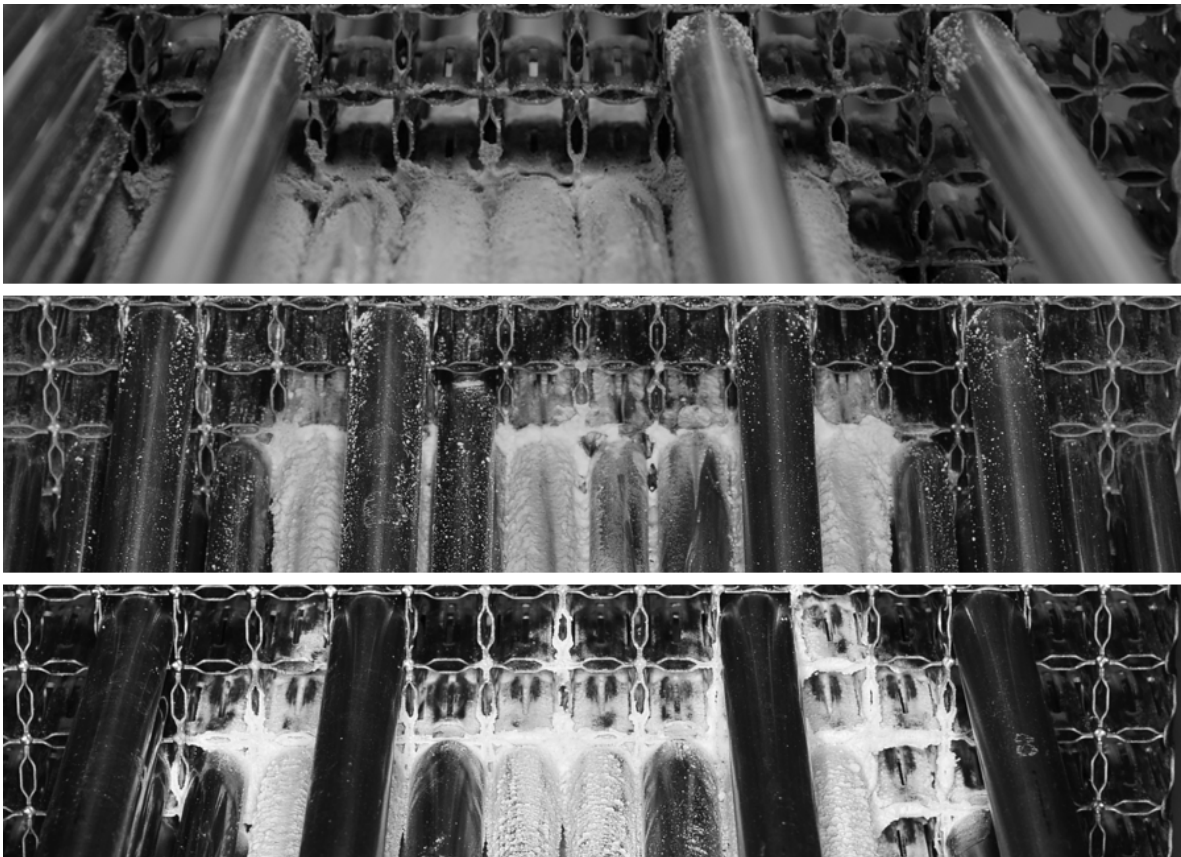

Figure 22: Cloggings at the upper spacer caused by CP deposits at several alkalization levels (in dried state; from top to bottom: exp. no. ZFT-BE-V02 (0.5 ppm Li), V06 (15 ppm Li) and V05 (38 ppm Li); view in flow direction)

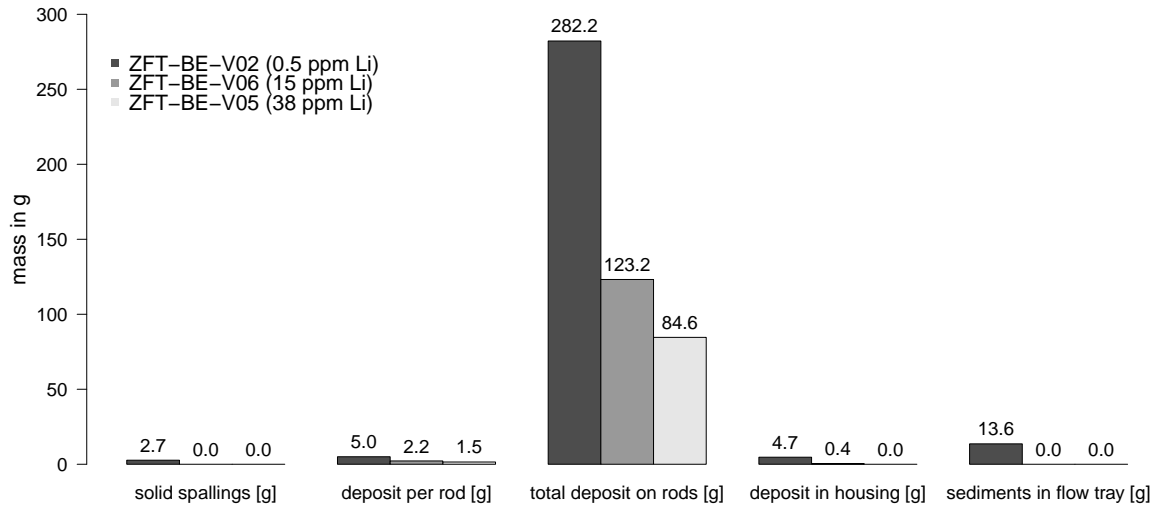

Figure 23: Masses of secondary zinc CP retrieved in dried state after end of exp. no. ZFT-BE-V02, V05 and V06

6. Conclusions

Investigation at semi-technical scale have been aiming at the corrosion behavior of common hot-dip galvanized zinc installations under LOCA conditions and the influence of zinc release on the coolant chemistry. Possible thermal-hydraulic consequences considering the presence of zinc ions in the PWR core generating decay heating power were compiled by taking comparable experimental conditions into account. According to the results, possible influences on long-term cooling capability of decay heat in hot channels of PWR fuel assemblies after LOCA and sump recirculation are:

- Deposits at spacers block the free mass flow of single phase coolant water along the flow channels.
- Deposits reduce the flow area between the fuel rods and deteriorate the heat transfer from the rod surfaces to the coolant.
- Along the reduced flow channel, the coolant temperature rises in comparison to the unblocked channels. Temperatures inside the fuel rods and in the fuel increase.
- A rise in the rod surface temperature can cause further deposits.
- A degassing of air (dissolved in the containment into the coolant) occurs. Degassing and evaporation of water at saturation temperature lead to a two-phase flow in the hot channel.
- Two-phase flow induced increasing head loss with further decrease of mass flow and acceleration of these processes.
- Deposits can form a porous body inside flow channels.
- A further heating increases the dehydration of the porous body of the deposits.
- ZBP can be an impending risk due to loss of integrity of fuel rods and release of radioactive fission gases.

Borated coolant supports flow-induced corrosion processes at zinc-coated surfaces of internal PWR installations e.g. HGG. Zinc release rates were determined in dependence of position, size resp. contact surface, jet flow rate and chemical attributes of the surrounding coolant fluid. The release rate of zinc depends

mainly on coolant chemistry (pH), flow profile and the presence of entrained air. Hence, most zinc ions are released at HGG, which are located in the leaking jet itself above the sump level. The release rate of zinc ions is higher at immersed HGG near the water surface and below the leaking jet position where air bubbles are entrained into the coolant. The lowest zinc release rates were measured at HGG with contact to the coolant without entrained air. Additional ZR experiments showed that zinc ions were released even when HGG are immersed in stagnant coolant. According to zinc solubility scheme (Fig.3), dependence between initial zinc concentration and temperature of first appearance of zinc borates in the coolant (RL2) was experimentally proven. As a further fact, after each experiment each HGG is still able to act as a zinc source. Zinc in ionic form will be able to reach the core in spite of existing mechanical filtering components.

Considering previous experiments of the HZDR, the temperature-dependent layer-forming deposits at heatable surfaces and further lab results were proven for the semi-technical scale. Both classes of zinc-containing deposits (remobilisable flocculent phase and crystalline solid ones, see Fig.11) were successfully identified. Secondary CP which remain for a time period of several hours at hot surfaces turn into a highly porous layers (incrustation as a variety of solidification).

Alkalinization using lithium hydroxide is the only preventive measure considering additives which are present in the in-core coolant anyway. According experiments have shown that the release of zinc ions can be reduced by increasing the pH-value of the coolant. For all alkalinization levels considered experimentally, Zn concentration over experimental time shows similar courses (first linear increase, followed by an asymptotic behavior). Results indicate that Zn release rate can be decreased but a formation of zinc corrosion products (zinc borates) at hot spots in the reactor core cannot be fully prevented by moderate amounts of alkalinizing agents. Higher pH-values within the alkaline region carry the risk of formation of sparingly soluble zincates as well as enhanced foaming of the coolant as observed during lab-scale experiments of HZDR. Any preventive measurements concerning sump clogging (e.g. backflushing procedure) will have no influence on zinc borate release inside the core.

All analyses and experiments at lab and semi-technical scale done so far by the HSZG and the HZDR had generic and descriptive character. Previous findings allow to describe the phenomena, which can be caused by the release of zinc ions into borated coolant and the formation of solid zinc borates due to the presence of heated surfaces. Although they allow for the evaluation of condition-based mechanisms of formation, transport and deposition of zinc borates, they do not support conclusions yet like time-related assignments of all parallel running processes (e.g. interacting mechanisms at zinc sources) during PWR LOCA as well as any statement concerning influences on the integrity of fuel rod cladding tubes in the PWR core. As a consequence for upcoming experiments, boundary conditions and relations according to specific LOCA incidents in a generic PWR will be considered. Mechanisms of zinc borate formation under various boundary conditions in detail are complex and still widely unknown.

Considering LOCA in reality, the transfer of decay heat after SCRAM is supported by ECCS to prevent core damage. Otherwise, their use influences local zinc concentrations of the coolant. Defining representative LOCA scenario(s) for country-specific plant configurations and water-chemical conditions plus relating consequences for experimental boundary conditions will be the first step in forthcoming investigations. For this, an extended version of the FRS will represent heating channel in its entire heated length (3.9 m) with full number of spacers at original positions.

7. Acknowledgements

The authors would like to acknowledge the financial support provided by the German Federal Ministry for Economic Affairs and Energy (BMWi) under grant nr. 1501430, 1501431, 1501467, 1501468, 1501491 and 1501496.

References

- C. Shaffer, D. Rao, M. Leonard, K. Ross, NUREG/CR-6808, Knowledge Base for the Effect of Debris on Pressurized Water Reactor Emergency Core Cooling Sump Performance, Website, available from <http://adams.nrc.gov/wba/>, 2003.

- A. Seeliger, R. Hampel, S. Alt, Characterisation of size, shape and motion behaviour of insulation particles in coolant flow using image processing methods, in: Proceedings of the 6th International FLINS Conference on Applied Artificial Intelligence, Blankenberge, Belgium, 2004.
- A. Bröcker, W. Pointner, LOCAs with release of insulation material: Generic Aspects and International Solutions, 2011.
- E. Krepper, G. Cartland-Glover, A. Grahn, F. Weiss, S. Alt, A. Kratzsch, S. Renger, W. Kästner, CFD analyses of fibre transport and fibre deposition at plunging jet conditions, in: Kerntechnik, Carl Hanser Verlag, Munich, 30–38, 2011.
- H. Kryk, W. Hoffmann, W. Kästner, S. Alt, A. Seeliger, S. Renger, Zinc corrosion after loss-of-coolant accidents in pressurized water reactors - Physicochemical effects, *Nuc.Eng.Des.* 280 (2014) 570–578.
- W. Kästner, S. Alt, M. Hölker, S. Kittan, A. Kratzsch, M. Pfeiffer, S. Renger, A. Seeliger, F. Zacharias, M. Wagenknecht, Insulation-debris loaded coolant flows at the core - experiments and data analysis, final report BMWA 1501360 (available in German only), 2012.
- S. Renger, S. Alt, W. Kästner, A. Seeliger, D. Fiss, Investigation of conditions for zinc particle release and transport in the reactor core, in: Proceedings of the 21th International Conference on Nuclear Engineering (ICONE21), Chengdu, China, 2013.
- H. Kryk, W. Hoffmann, Formation of zinc corrosion products at waterchemical PWR post-LOCA conditions - Physicochemical effects, in: Proceedings of the Annual Meeting on Nuclear Technology, Frankfurt/Main, Germany, 2014.